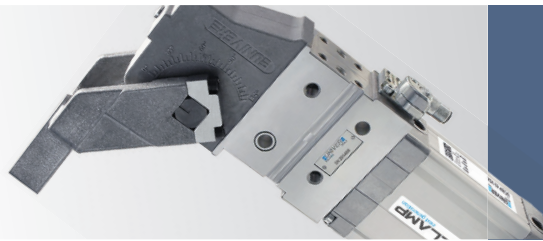
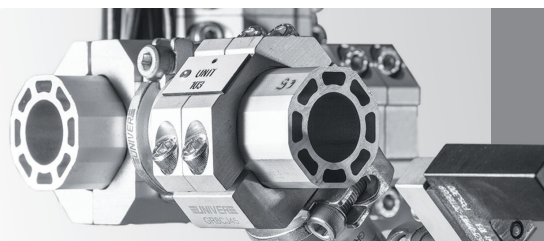


**PNEUMATIC
AUTOMATION**



AUTOMOTIVE



**MODULAR
TOOLING
SYSTEM**

**PRODUCT
OVERVIEW**

UNIVER S.p.A.

Headquarters

20128 Milano - ITALY

Via Eraclito, 31

Tel. +39 02 25298.1

Fax +39 02 2575254

info@univer-group.com

www.univer-group.com

In light of technical updates, **Univer S.p.A.** reserves the right to modify technical features of their products with no obligation to issue prior notice.

Information contained in the present catalogue is pure indication, for further details about product technical features and related parameter values to be respected for a proper functioning, please refer to the datasheets available at:

www.univer-group.com

All rights reserved to **Univer S.p.A.** Unauthorized reproduction prohibited.

BUSINESS PROFILE

PRODUCT HISTORY

SALES NETWORK

Pneumatic Automation

1

Cylinders



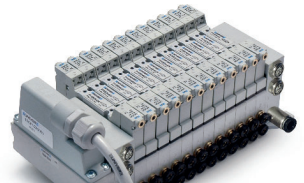
2

High-Tech



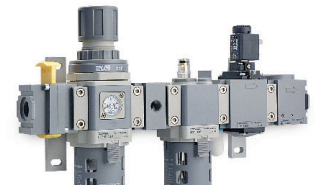
3

Valves



4

Air Treatment



5

Accessories



Automotive

6

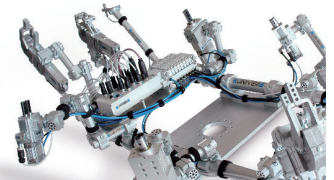
Clamping Technology

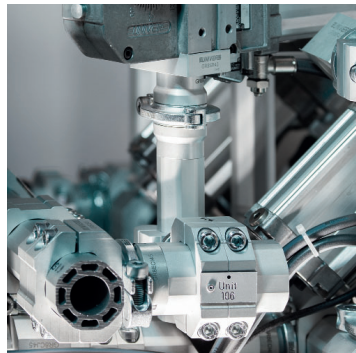
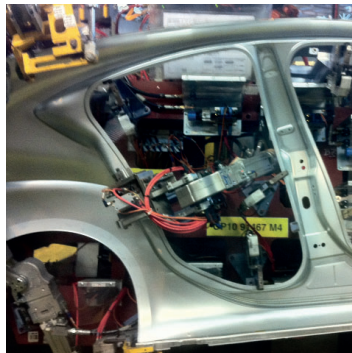
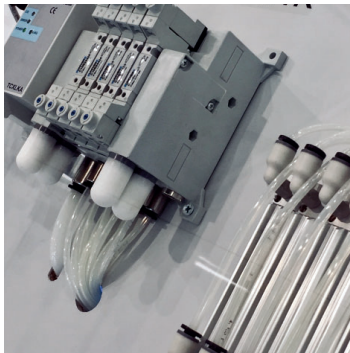
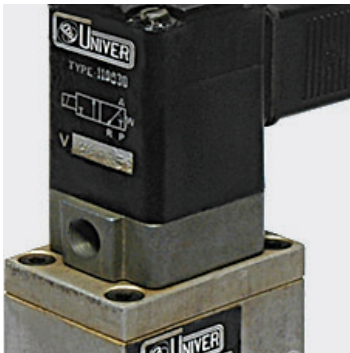


Modular Tooling System

7

GR8 Tooling





Early stages

UNIVER has started its activity in the field of industrial automation during the 1970s, with the production of its first series of pneumatic valves and poppet valves for vacuum.

Pneumatic

In the following decades, the widening range of technologically advanced and original pneumatic components has allowed the continuous growth and development of the company, which has become one of the major Italian businesses in the production of industrial automation equipment.

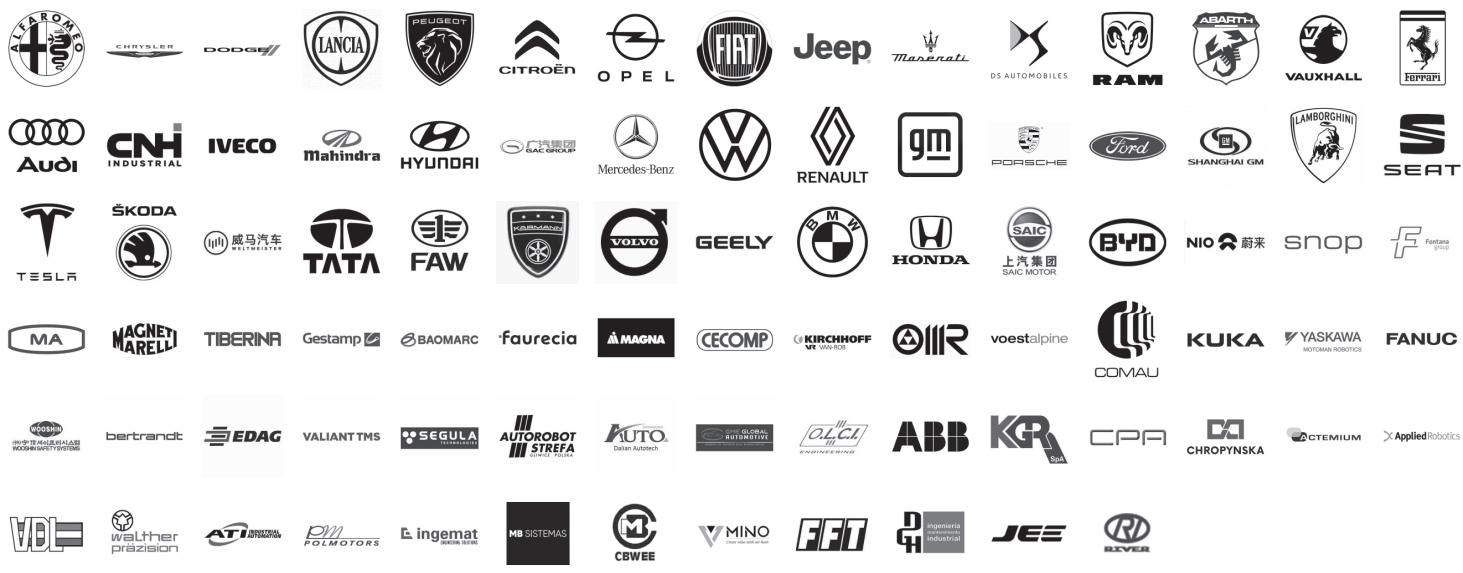
Automotive

In 2000, after many years of experience in the supply of pneumatic components to the automotive market, the Automotive Division was created, thus developing numbers of solutions for BIW in the automotive industry.

GR8 Tooling

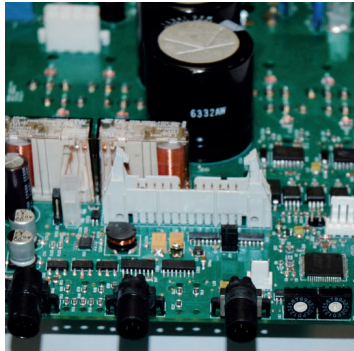
New entry, the Division of Modular Tooling Systems (GR8) represents the new challenge in the press field and handling of metal sheets in Automotive and Industrial Automation.

OUR CUSTOMERS





BUSINESS PROFILE



Electronics

The Electronic Division, supporting both Pneumatic Automation and Automotive divisions, is specialized in the study, design and manufacturing of the electric and electronic devices which are integrated in UNIVER products.



Univer Service

In Italy, the commercial company **UNIVER SERVICE S.r.l.** controls the domestic market and guarantees a quick and efficient service, thanks to different operational offices and distributors in the whole country.



Univer Group

The UNIVER Group has many direct branches and an active distribution network covering the most important industrialized areas.



since **1971**
KNOW-HOW
RESEARCH
INNOVATION





- 1971** Foundation of UNIVER company
- 1973** Poppet valves for compressed air and vacuum



- 1980** Valves according to ISO 5599 (Industry Award)
- 1982** UNIVERSAL series valves
- 1986** Cylinders and mounting elements according to ISO 6431 (first cylinders on the market with extruded aluminium profile)
- 1988** Cylinders with antirotation piston and octagonal tube
Electrically actuated microvalves
Rodless cylinders (patented)
- 1989** Rotating cylinders (patented)
Short-stroke cylinders

- 1991** 10 mm Nanovalve
G6 - G7 - G8 series valves
- 1992** Slide units in extruded aluminium profile
- 1993** Cybrain programmable actuators (patented)
- 1997** Telescopic cylinders (patented)
- 1998** Locking units (patented)
- 1999** Compact cylinders with supplied adjustable cushioning standard (patented)

1970

1980

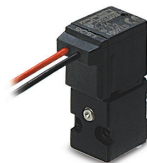
1990



First valve series



ISO 6431 Pneumatic Cylinders



10 mm Nanovalve



2/3 stage Telescopic Pneumatic Cylinders



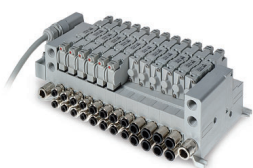
Pneumatic and Electric Power Clamps

PRODUCT HISTORY

- 2000** Combobox valves
- 2001** Pneumatic power clamps and retractable locating pin units
- 2002** Oval cylinders
- 2003** Electric cylinders (patented)
Electric power pivots
Electric power clamps and retractable locating pin units
- 2004** Valves according to ISO 15407/VDMA 24563
Serial communication control blocks
Pneumatic grippers
- 2005** Pneumatic power pivots (patented)
- 2006** 10 mm Nanovalve - 2nd generation
- 2007** COMPACT 10/15 mm valves
- 2008** TC Serial communication control system
- 2009** JL Guided compact cylinders
KL Cylinders according to ISO 15552
- 2010** Compact cylinders Ø 80-100 according to ISO 21287
HZE Air treatment system
ISO 15552 Pneumatic cylinders
- 2011** 10 mm bistable Nanovalves
Marking unit
- 2012** P15E 15 mm COMPACT Valves
GR8 Modular Tooling System
- 2013** Short Stroke Cylinders - Tube New Design
Valves with panel operation
Pneumatic Gripper
- 2014** ESSENTIAL valves
P22 22 mm COMPACT valves
- 2017** TC-E Modular Control System
- 2018** Sub-base Multipin for ESSENTIAL Valves
- 2019** CompactEvo Valves
KR Cylinders
IO-Link Module
Pneumatic power clamps UNICLAMP
Pneumatic power clamps BLUECLAMP
Power pivots e-PIVOT

2000

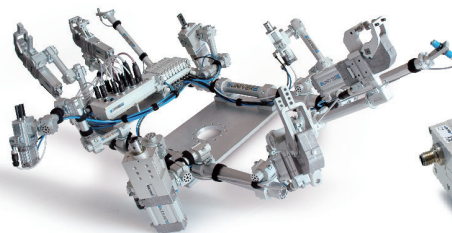
2010



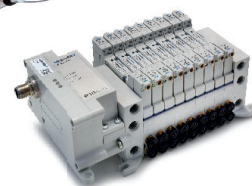
COMPACT Valves



ISO 15552 Pneumatic Cylinders



Modular Tooling System



IO-Link Module



Pneumatic Power Clamps
UNICLAMP

Univer Service

In Italy, the commercial company **UNIVER SERVICE S.r.l.** controls the domestic market and guarantees a quick and efficient service, thanks to different operational offices and distributors in the whole country.



UNIVER SERVICE S.r.l.

Headquarters

20128 Milano - ITALY
Via Empedocle, 20
Tel. +39 02 25298.1
Fax +39 02 25298370
universervice@universervice.it

LOMBARDIA



UNIVER SERVICE S.r.l.
20099 Sesto San Giovanni - **Milano**
Via G. di Vittorio, 307/20
universervice@universervice.it

PIEMONTE/LIGURIA/VALLE D'AOSTA



UNIVER SERVICE S.r.l.
10071 Borgaro Torinese - **Torino**
Via Veneto, 18
torino@universervice.it

EMILIA ROMAGNA - CENTRO/SUD



UNIVER SERVICE S.r.l.
40069 Zola Predosa - **Bologna**
Via Balzani, 5
bologna@universervice.it

VENETO/FRIULI-VENEZIA GIULIA/TRENTINO-ALTO ADIGE



UNIVER SERVICE S.r.l.
30030 Vigonovo - **Venezia**
Via Prima strada, 16/A - Loc. Galta
vigonovo@universervice.it



SALES NETWORK

Univer Group

The UNIVER Group has many direct branches and an active distribution network covering the most important industrialized areas.



UNIVER S.p.A.

Headquarters

20128 Milano - ITALY
Via Eraclito, 31
Tel. +39 02 25298.1
Fax +39 02 2575254
info@univer-group.com

BRAZIL



UNIVER do Brasil S/A
univerbrasil@univer.com.br

INDIA



JV UNIVER INDIA
enquiry@natashaenterprises.co.in

CHINA



UNIVER CHINA
info@univer-china.com

POLAND



UNIVER Polska Sp. z o.o.
univer@univer-group.pl

FRANCE



UNIVER FRANCE Sas
info@univer-france.fr

SPAIN



UNIVER S.L.
System Supplier Pneumatic
univer@univerweb.com

GERMANY



UNIVER G.m.b.H.
info@univer-gmbh.de

USA













UNIVER NORTH AMERICA
info@univer-group.us

www.univer-group.com

1

Cylinders



	Standards-based Cylinders	M KL KE KD K	2 4 6 7 8/9
	Standards-based Compact Cylinders	RP RM RO RN RS RQ	11 12 13 14 16 17
	Stainless steel Cylinders	PM PK PRM	19/20 21 22
	Oval Cylinders	OV	23/24
	Short-stroke Cylinders	W	25
	Rotary Cylinders	R YR2 YR3	26 27 28
	Rodless Cylinders	S1 S5 VL1	30 31 32
	Guided Cylinders	J JLE JTE/JX	34/35/36 37 38
	Other Cylinders	MP	39
	Assembly Kits	M/K RP/RM RO/RN RS/RQ S1/S5/VL1	40 41 41 41 42

1
CHARACTERISTICS

Ambient temperature	-20 ÷ 80 °C
Fluid	filtered air, with or without lubrication
Working pressure	1,5 ÷ 10 bar
End-caps	aluminium, crimped on barrel
Barrel	stainless steel
Piston	brass (Ø8÷16), aluminium (Ø20-25)
Guide slide	acetalic resin
Piston rod	stainless steel
Piston seal	NBR
Guide bush for piston rod	standard supplied
Shock absorber seals	NBR
Cushionings	adjustable on both sides (Ø16÷25)


CODIFICATION KEY

M	1	0	0	0	2	5	0	0	5	0			
1	2	3	4		5			6	7	8			

1 Series	2 Type	3 Version	4 Bore (mm)
M = Ø8÷25 mm ISO 6432 Microcylinders	1 = Stainless steel piston rod (standard vesion) 2 = Chromium-plated steel piston rod (to be used only with locking unit) 3 = Reduced version with stainless steel piston rod	00 = D.A. Standard version 01 = D.A. Through piston rod 50 = D.A. With adjustable cushionings (Ø16÷25) 51 = D.A. Through piston rod with adjustable cushionings (Ø16÷25) 60 = S.A. Retracted piston rod (Ø10÷25), Max stroke 50 mm 70 = S.A. Extended piston rod (Ø16÷25), Max stroke 25 mm D.A. = Double acting S.A. = Single acting	008 = Ø8 010 = Ø10 012 = Ø12 016 = Ø16 020 = Ø20 025 = Ø25

5 Stroke (mm)	6 Option	7 Magnetic	8 ATEX option
0010 = 10 0080 = 80 0250 = 250 0020 = 20 0100 = 100 0300 = 300 0025 = 25 0125 = 125 0320 = 320 0030 = 30 0150 = 150 0400 = 400 0040 = 40 0160 = 160 0500 = 500 0050 = 50 0175 = 175 0075 = 75 0200 = 200	F = Preset for locking unit reduced protrusion	M = Magnetic version (Ø10÷25)	X = ATEX (upon request) See ATEX Catalogue for types and versions

M190 version with high temperature seals (Max 120°C) available upon request

FIXING ELEMENTS AND ACCESSORIES

Ø	Female fork with clips	Articulated self-lubricating fork	Fork with axially mounted articulated pin	Fork with angle mounted articulated pin	Floating joint	Female rear hinge	Angle bracket	Flange	Nut for end-cap	Holder for DF sensor	DF sensor
8			-	-	-					-	DF
10	MF-15008	MF-17008	-	-	-	MF-21008	MF-13008	MF-12008	MF-20008	DH-M10DF	
12	MF-15012	MF-17012	MF-22016	MF-23012	MF-24012	MF-21012	MF-13012	MF-12012	MF-20012	DH-M12DF	
16	MF-15012	MF-17012	MF-22016	MF-23012	MF-24012	MF-21012	MF-13012	MF-12012	MF-20012	DH-M16DF	
20	MF-15020	MF-17020	MF-22020	MF-23020	MF-24020	MF-21020	MF-13020	MF-12020	MF-20020	DH-M20DF	
25	KF-15032	KF-17032	KF-22025	KF-23025	KF-24032	MF-21020	MF-13020	MF-12020	MF-20020	DH-M25DF	

Ø	Holder for DH sensor	DH sensor
8		
10	DH-M10	
12	DH-M12	
16	DH-M16	
20	DH-M20	
25	DH-M25	

■ Through piston rod



■ Reduced version with adjustable cushionings





KL

CLEAN PROFILE

Easier to clean

QUICK INSTALLATION

Sensors and connections on one side

UNIVER TECHNOLOGY

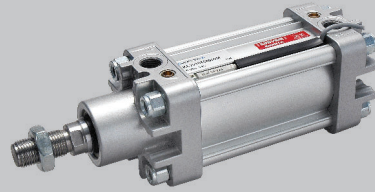
Strong and Reliable

ISO 15552

Interchangeability

KE

Ø 32 ÷ 125 mm



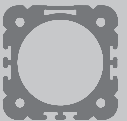
KL

Ø 32 ÷ 125 mm



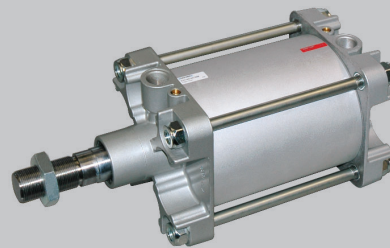
KD

Ø 32 ÷ 125 mm



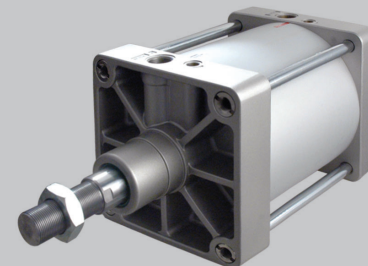
K 160/200

Ø 160 - 200 mm



K 250/320

Ø 250 - 320 mm



KIT Assembly Kit
available for all series



1

CHARACTERISTICS

Ambient temperature	-20 ÷ 80 °C
Fluid	filtered air, with or without lubrication
Working pressure	1,5 ÷ 10 bar
End-caps	die-cast aluminium
Barrel	anodized aluminium
Piston	die-cast aluminium
Guide slide	acetalic resin
Piston rod	chromium-plated steel, stainless steel upon request
Piston seal	NBR
Guide bush for piston rod	UNIVER Original self-lubricating and self-aligning
Shock absorber seals	NBR
Cushionings	adjustable on both sides
Other available versions	tandem, two-position tandem, opposed, with common piston rod (upon request)



CODIFICATION KEY

K	L	2	0	0	0	3	2	0	0	5	0		M	
1	2	3	4	5	6	7	8							

1 Series	2 Type	3 Version	4 Bore (mm)
KL = Ø 32÷125 mm - ISO 15552 Pneumatic Cylinders	1 = Stainless steel piston rod 2 = Chromium-plated steel piston rod	00 = D.A. Standard version 01 = D.A. Through piston rod 60 = S.A. Retracted piston rod Max stroke 50 mm 70 = S.A. Extended piston rod Max stroke 50 mm D.A. = Double acting S.A. = Single acting	032 = Ø32 040 = Ø40 050 = Ø50 063 = Ø63 080 = Ø80 100 = Ø100 125 = Ø125
Magnetic version standard supplied			

5 Stroke (mm)	6 Option	7 Magnetic	8 ATEX option
0025 = 25 0150 = 150 0320 = 320 0700 = 700 0050 = 50 0160 = 160 0350 = 350 0800 = 800 0075 = 75 0175 = 175 0400 = 400 0900 = 900 0080 = 80 0200 = 200 0450 = 450 1000 = 1000 0100 = 100 0250 = 250 0500 = 500 0125 = 125 0300 = 300 0600 = 600	F = Preset for locking unit reduced protrusion G = Preset for locking unit ISO protrusion	M = Magnetic version standard supplied	X = Atex (upon request) See ATEX Catalogue for types and versions

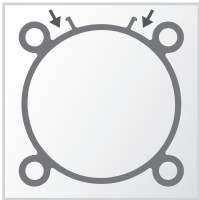
KL190 and KL290 versions with high temperature seals (Max 120°C) and versions with low temperature seals (Max -30°C) available upon request

FIXING ELEMENTS AND ACCESSORIES

Ø	Female fork with clips	Articulated self-lubricating fork	Fork with axially mounted articulated pin	Fork with angle mounted articulated pin	Floating joint	Female rear hinge with pin	Counter hinge 90° (CETOP)	Counter hinge 90°	Counter hinge 90° (CNOMO)	Narrow female hinge with pin	Articulated counter hinge
32											
40	KF-15032	KF-17032	KF-22025	KF-23025	KF-24032	KF-10032A	KF-19032CTA	KF-19032	KF-19032CN	KF-10032AS	KF-19032SC
50	KF-15040	KF-17040	KF-22040	KF-23040	KF-24040	KF-10040A	KF-19040CTA	KF-19040	KF-19040050CN	KF-10040AS	KF-19040SC
63	KF-15050	KF-17050	KF-22050	KF-23050	KF-24050	KF-10050A	KF-19050CTA	KF-19050	KF-19040050CN	KF-10050AS*	KF-19050SC
80	KF-15080	KF-17080	KF-22080	KF-23080	KF-24080	KF-10063A	KF-19063CTA	KF-19063	KF-19063080CN	KF-10063AS	KF-19063SC
100	KF-15080	KF-17080	KF-22080	KF-23080	KF-24080	KF-10080A	KF-19080CTA	KF-19080	KF-19063080CN	KF-10080AS*	KF-19080SC
125	KF-15125	KF-17125	-	-	-	KF-10100A	KF-19100CTA	KF-19100	KF-19100125CN	KF-10100AS	KF-19100SC

Ø	Articulated rear male hinge	Rear male hinge	Front/rear flange	Angle bracket	Front/rear hinge with floating pin	Hinge support	ISO intermediate hinge	DF sensor and DHF covering strip
32								
40	KF-11032S	KF-11032	KF-12032	KF-13032	KF-14032AP	KF-41032	KLF-14032	DF DHF-0020100
50	KF-11040S	KF-11040	KF-12040	KF-13040	KF-14040AP	KF-41040050	KLF-14040	
63	KF-11050S	KF-11050	KF-12050	KF-13050	KF-14050AP	KF-41040050	KLF-14050	
80	KF-11063S	KF-11063	KF-12063	KF-13063	KF-14063AP	KF-41063080	KLF-14063	
100	KF-11080S	KF-11080	KF-12080	KF-13080	KF-14080AP	KF-41063080	KLF-14080	
125	KF-11100S	KF-11100	KF-12100	KF-13100	KF-14100AP	KF-41100125	KLF-14100	

* = If employed with articulated rear male hinge diameter 50-80 use KF-11050SSA (pin Ø16) and KF-11080SSA (pin Ø20)



Tube profile with integrated sensor grooves
UNIVER Original since 2005



Recessed sensor
DF series



Magnetic piston
standard supplied



Fixing screws integrated in
the end-cap profile



Sensor grooves available
in different positions



Possibility to mount DH
sensors with brackets



Intermediate hinge with locking
system guaranteed by UNIVER
AUTOMOTIVE expertise

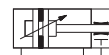
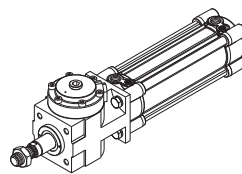


Standard fixing elements
UNIVER Original

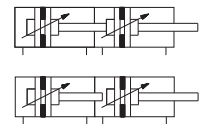
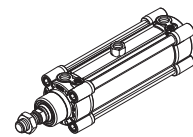
- 1 Die-cast end-caps in aluminium
- 2 Die-cast piston in aluminium
- 3 Guide slide in acetalic resin with integrated magnetic ring
- 4 Wear-resistant shock absorber seals in nitrilic rubber compound
- 5 Lip piston seals in nitrile rubber compound
- 6 **UNIVER Original** self-aligning and self-lubricating guide bush for piston rod

Other available versions

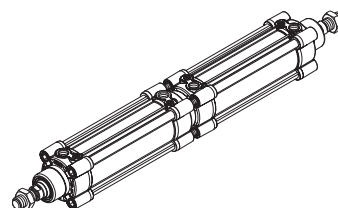
■ Cylinder with L1-N locking unit



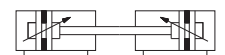
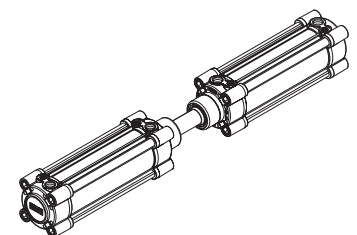
■ Tandem cylinder
Two-position tandem cylinder



■ Opposed cylinders



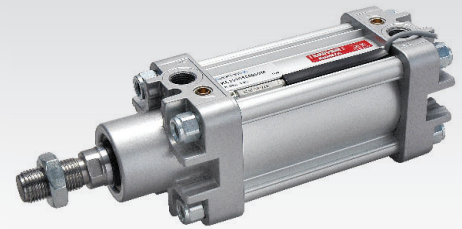
■ Cylinders with common piston rod



1

CHARACTERISTICS

Ambient temperature	-20 ÷ 80 °C
Fluid	filtered air, with or without lubrication
Working pressure	1,5 ÷ 10 bar
End-caps	die-cast aluminium
Barrel	anodized aluminium
Piston	die-cast aluminium
Guide slide	acetalic resin
Piston rod	chromium-plated steel, stainless steel upon request
Piston seal	NBR
Guide bush for piston rod	UNIVER Original self-lubricating and self-aligning
Shock absorber seals	NBR
Cushionings	adjustable on both sides
Other available versions	tandem, two-position tandem, opposed, with common piston rod (upon request)



CODIFICATION KEY

K	E	2	0	0	0	3	2	0	0	5	0			
1	2	3	4	5	6	7	8							

1 Series	2 Type	3 Version	4 Bore (mm)	5 Stroke (mm)	6 Option	7 Magnetic	8 ATEX Option
KE = Ø 32÷125 mm - ISO 15552 Pneumatic Cylinders	1 = Stainless steel piston rod 2 = Chromium-plated steel piston rod	00 = D.A. Standard version 01 = D.A. Through piston rod 60 = S.A. Retracted piston rod Max stroke 50 mm 70 = S.A. Extended piston rod Max stroke 50 mm D.A. = Double acting S.A. = Single acting	032 = Ø32 040 = Ø40 050 = Ø50 063 = Ø63 080 = Ø80 100 = Ø100 125 = Ø125	0025 = 25 0150 = 150 0320 = 320 0700 = 700 0050 = 50 0160 = 160 0350 = 350 0800 = 800 0075 = 75 0175 = 175 0400 = 400 0900 = 900 0080 = 80 0200 = 200 0450 = 450 1000 = 1000 0100 = 100 0250 = 250 0500 = 500 0125 = 125 0300 = 300 0600 = 600	F = Preset for locking unit reduced protrusion G = Preset for locking unit ISO protrusion	M = Magnetic version	X = ATEX (upon request) See ATEX Catalogue for types and versions

KE190 and KE290 versions with high temperature seals (Max 120°C) and versions with low temperature seals (Max -30°C) available upon request

FIXING ELEMENTS AND ACCESSORIES

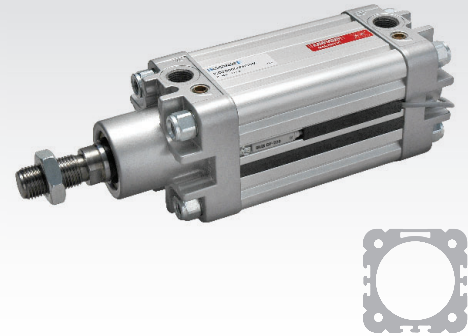
Ø	Female fork with clips	Articulated self-lubricating fork	Fork with axially mounted articulated pin	Fork with angle mounted articulated pin	Floating joint	Female rear hinge with pin	Counter hinge 90° (CETOP)	Counter hinge 90°	Counter hinge 90° (CNOMO)	Narrow female hinge with pin	Articulated counter hinge
32											
40	KF-15032	KF-17032	KF-22025	KF-23025	KF-24032	KF-10032A	KF-19032CTA	KF-19032	KF-19032CN	KF-10032AS	KF-19032SC
50	KF-15040	KF-17040	KF-22040	KF-23040	KF-24040	KF-10040A	KF-19040CTA	KF-19040	KF-19040050CN	KF-10040AS	KF-19040SC
63	KF-15050	KF-17050	KF-22050	KF-23050	KF-24050	KF-10050A	KF-19050CTA	KF-19050	KF-19040050CN	KF-10050AS*	KF-19050SC
80	KF-15080	KF-17080	KF-22080	KF-23080	KF-24080	KF-10080A	KF-19080CTA	KF-19080	KF-19063080CN	KF-10063AS	KF-19063SC
100	KF-15080	KF-17080	KF-22080	KF-23080	KF-24080	KF-10100A	KF-19100CTA	KF-19100	KF-19063080CN	KF-10080AS*	KF-19080SC
125	KF-15125	KF-17125	-	-	-	KF-10125A	KF-19125CTA	-	KF-19100125CN	KF-10100AS	KF-19100SC
Ø	Articulated rear male hinge	Rear male hinge	Front / rear flange	Angle bracket	Front / rear hinge with floating pin	Hinge support	ISO Intermediate hinge	ISO Intermediate hinge	DF sensor and DHF covering strip	DH sensor	Mounting bracket for DH sensor
32											
40	KF-11032S	KF-11032	KF-12032	KF-13032	KF-14032AP	KF-41032	KLF-14032	KF-14032	DF DHF-0020100	DH	DH-K032050 DH-K032050 DH-K032050 DH-K063125 DH-K063125 DH-K063125
50	KF-11040S	KF-11040	KF-12040	KF-13040	KF-14040AP	KF-41040050	KLF-14040	KF-14040			
63	KF-11050S	KF-11050	KF-12050	KF-13050	KF-14050AP	KF-41040050	KLF-14050	KF-14050			
80	KF-11063S	KF-11063	KF-12063	KF-13063	KF-14063AP	KF-41063080	KLF-14063	KF-14063			
100	KF-11080S	KF-11080	KF-12080	KF-13080	KF-14080AP	KF-41063080	KLF-14080	KF-14080			
125	KF-11100S	KF-11100	KF-12100	KF-13100	KF-14100AP	KF-41100125	KLF-14100	KF-14100			
	KF-11125S	KF-11125	KF-12125	KF-13125	KF-14125AP	KF-41100125	KLF-14125	KF-14125			

* = If employed with articulated rear male hinge diameter 50-80 use KF-11050SSA (pin Ø16) and KF-11080SSA (pin Ø20)

**= Fixing elements and accessories for K series

CHARACTERISTICS

Ambient temperature	-20 ÷ 80 °C
Fluid	filtered air, with or without lubrication
Working pressure	1,5 ÷ 10 bar
End-caps	die-cast aluminium
Barrel	anodized aluminium
Piston	die-cast aluminium
Guide slide	acetalic resin
Piston rod	chromium-plated steel, stainless steel upon request
Piston seal	NBR
Guide bush for piston rod	UNIVER Original self-lubricating and self-aligning
Shock absorber seals	NBR
Cushionings	adjustable on both sides
Other available versions	tandem, two-position tandem, opposed, with common piston rod (upon request)



CODIFICATION KEY

K	D	2	0	0	0	3	2	0	0	5	0		M	
1	2	3	4	5	6	7	8							

1 Series	2 Type	3 Version	4 Bore (mm)
KD = Ø 32÷125 mm - ISO 15552 Pneumatic Cylinders	1 = Stainless steel piston rod 2 = Chromium-plated steel piston rod	00 = D.A. Standard version 01 = D.A. Through piston rod 60 = S.A. Retracted piston rod Max stroke 50 mm 70 = S.A. Extended piston rod Max stroke 50 mm D.A. = Double acting S.A. = Single acting	032 = Ø32 040 = Ø40 050 = Ø50 063 = Ø63 080 = Ø80 100 = Ø100 125 = Ø125
Magnetic version standard supplied			
5 Stroke (mm)	6 Option	7 Magnetic	8 ATEX Option
0025 = 25 0150 = 150 0320 = 320 0700 = 700 0050 = 50 0160 = 160 0350 = 350 0800 = 800 0075 = 75 0175 = 175 0400 = 400 0900 = 900 0080 = 80 0200 = 200 0450 = 450 1000 = 1000 0100 = 100 0250 = 250 0500 = 500 0125 = 125 0300 = 300 0600 = 600	F = Preset for locking unit reduced protrusion G = Preset for locking unit ISO protrusion	M = Magnetic version standard supplied	X = ATEX (upon request) See ATEX Catalogue for types and versions

KD190 and KD290 versions with high temperature seals (Max 120°C) and versions with low temperature seals (Max -30°C) available upon request

FIXING ELEMENTS AND ACCESSORIES

Ø	Female fork with clips	Articulated self-lubricating fork	Fork with axially mounted articulated pin	Fork with angle mounted articulated pin	Floating joint	Female rear hinge with pin	Counter hinge 90° (CETOP)	Counter hinge 90°	Counter hinge 90° (CNOMO)	Narrow female hinge with pin	Articulated counter hinge
32											
40	KF-15032	KF-17032	KF-22025	KF-23025	KF-24032	KF-10032A	KF-19032CTA	KF-19032	KF-19032CN	KF-10032AS	KF-19032SC
50	KF-15040	KF-17040	KF-22040	KF-23040	KF-24040	KF-10040A	KF-19040CTA	KF-19040	KF-19040050CN	KF-10040AS	KF-19040SC
63	KF-15050	KF-17050	KF-22050	KF-23050	KF-24050	KF-10050A	KF-19050CTA	KF-19050	KF-19040050CN	KF-10050AS*	KF-19050SC
80	KF-15080	KF-17080	KF-22080	KF-23080	KF-24080	KF-10080A	KF-19080CTA	KF-19080	KF-19063080CN	KF-10063AS	KF-19063SC
100	KF-15080	KF-17080	KF-22080	KF-23080	KF-24080	KF-10100A	KF-19100CTA	KF-19100	KF-19063080CN	KF-10080AS*	KF-19080SC
125	KF-15125	KF-17125	-	-	-	KF-10125A	KF-19125CTA	-	KF-19100125CN	KF-10100AS	KF-19100SC

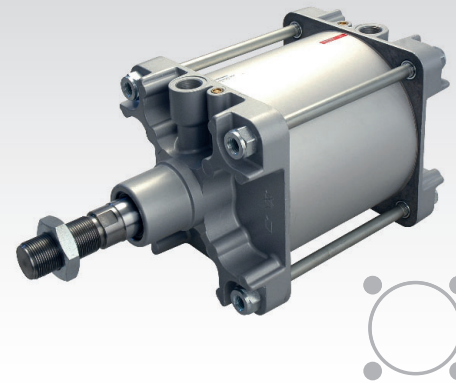
Ø	Articulated rear male hinge	Rear male hinge	Front / rear flange	Angle bracket	Front / rear hinge with floating pin	Hinge support	ISO Intermediate hinge	DF sensor and DHF covering strip	Cable clamping for DF sensor
32									
40	KF-11032S	KF-11032	KF-12032	KF-13032	KF-14032AP	KF-41032	KDF-14032	DF DHF-0020100	DF-001
50	KF-11040S	KF-11040	KF-12040	KF-13040	KF-14040AP	KF-41040050	KDF-14040		
63	KF-11050S	KF-11050	KF-12050	KF-13050	KF-14050AP	KF-41040050	KDF-14050		
80	KF-11063S	KF-11063	KF-12063	KF-13063	KF-14063AP	KF-41063080	KDF-14063		
100	KF-11080S	KF-11080	KF-12080	KF-13080	KF-14080AP	KF-41063080	KDF-14080		
125	KF-11100S	KF-11100	KF-12100	KF-13100	KF-14100AP	KF-41100125	KDF-14100		

* = If employed with articulated rear male hinge diameter 50-80 use KF-11050SSA (pin Ø16) and KF-11080SSA (pin Ø20)

1

CHARACTERISTICS

Ambient temperature	-20 ÷ 80 °C
Fluid	filtered air, with or without lubrication
Working pressure	1,5 ÷ 10 bar
End-caps	die-cast aluminium
Barrel	anodized aluminium
Tie-rods	zinc-plated steel
Piston	die-cast aluminium
Guide slide	acetalic resin
Piston rod	chromium-plated steel, stainless steel upon request
Piston rod scraper seals	NBR
Piston seals	polyurethane (Ø160) - NBR (Ø200)
Cushionings	adjustable on both sides
Other available versions	tandem, two-position tandem, opposed, with common piston rod (upon request)



CODIFICATION KEY

K	2	0	0	1	6	0	0	0	8	0		
1	2	3	4	5	6	7						

1 Series	2 Type	3 Version	4 Bore (mm)
K = Ø 160/200 mm - ISO 15552 Pneumatic Cylinders	1 = Stainless steel piston rod 2 = Chromium-plated steel piston rod	00 = D.A. Standard version 01 = D.A. Through piston rod	160 = Ø160 200 = Ø200

D.A. = Double acting

5 Stroke (mm)	6 Magnetic	7 ATEX option
0025 = 25 0150 = 150 0320 = 320 0700 = 700 0050 = 50 0160 = 160 0350 = 350 0800 = 800 0075 = 75 0175 = 175 0400 = 400 0900 = 900 0080 = 80 0200 = 200 0450 = 450 1000 = 1000 0100 = 100 0250 = 250 0500 = 500 0125 = 125 0300 = 300 0600 = 600	M = Magnetic version	X = ATEX (upon request) See ATEX Catalogue for types and versions

K190 and K290 versions with high temperature seals (Max 120°C) and versions with low temperature seals (Max -30°C) available upon request

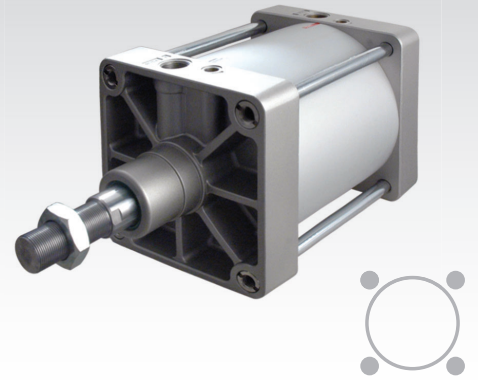
FIXING ELEMENTS AND ACCESSORIES

Ø	Female fork with clips	Articulated self-lubricating fork	Female rear hinge with pin	Counter hinge 90° (CETOP)	Narrow female hinge with pin	Articulated rear male hinge	Rear male hinge	Front/rear flange	Angle bracket	Front / rear hinge with floating pin	Hinge support
160											
200	KF-15160	KF-17160	KF-10160A	KF-19160CTA	KF-10160AS	KF-11160S	KF-11160	KF-12160	KF-13160	KF-14160AP	KF-41160200
	KF-15160	KF-17160	KF-10200A	KF-19200CTA	KF-10200AS	KF-11200S	KF-11200	KF-12200	KF-13200	KF-14200AP	KF-41160200

Ø	ISO intermediate hinge	DH sensor	Mounting bracket for DH sensor
160			
200	KF-14160	DH	DH-K160200
	KF-14200		DH-K160200

CHARACTERISTICS

Ambient temperature	-20 ÷ 80 °C
Fluid	filtered air, with or without lubrication
Working pressure	1,5 ÷ 10 bar
End-caps	die-cast aluminium
Barrel	anodized aluminium
Tie-rods	zinc-plated steel
Piston	die-cast aluminium
Guide slide	acetalic resin
Piston rod	chromium-plated steel, stainless steel upon request
Piston rod scraper seals	NBR
Piston seals	NBR
Cushionings	adjustable on both sides



CODIFICATION KEY

K	2	0	0	2	5	0	0	0	8	0		
1	2	3	4	5	6	7						

1 Series	2 Type	3 Version	4 Bore (mm)
K = Ø 250/320 mm - ISO 15552 Pneumatic Cylinders	1 = Stainless steel piston rod 2 = Chromium-plated steel piston rod	00 = D.A. Standard version 01 = D.A. Through piston rod	250 = Ø250 320 = Ø320

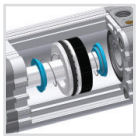
D.A. = Double acting

5 Stroke (mm)	6 Magnetic	7 ATEX option
0025 = 25 0150 = 150 0320 = 320 0700 = 700 0050 = 50 0160 = 160 0350 = 350 0800 = 800 0075 = 75 0175 = 175 0400 = 400 0900 = 900 0080 = 80 0200 = 200 0450 = 450 1000 = 1000 0100 = 100 0250 = 250 0500 = 500 0125 = 125 0300 = 300 0600 = 600	M = Magnetic version	X = ATEX (upon request) See ATEX Catalogue for types and versions

For versions with high temperature seals (Max 120°C) and versions with low temperature seals (Max -30°C) available upon request

FIXING ELEMENTS AND ACCESSORIES

Ø	Female fork with clips	Articulated self-lubricating fork	Female rear hinge with pin	Rear male hinge	Front/rear flange	ISO intermediate hinge	Pin for hinge	DH sensor	Mounting bracket for DH sensor	DF sensor	Mounting bracket for DF sensor
250											
320	KF-15250	KF-17250	KF-10250A	KF-11250	KF-12250	KF-14250	KF-18250	DH	DH-K250	DF	-
	KF-15320	KF-17320	KF-10320A	KF-11320	KF-12320	KF-14320	KF-18320		-		DH-K320DF



Adjustable pneumatic cushioning

UNIVER Original since 1999

- No change in dimensions comparing to an equivalent cylinder without cushionings
- Standard supplied for all models

STANDARDS-BASED

Available in compliance with UNITOP and ISO 21287 standards

STANDARD AND OCTAGONAL TUBE

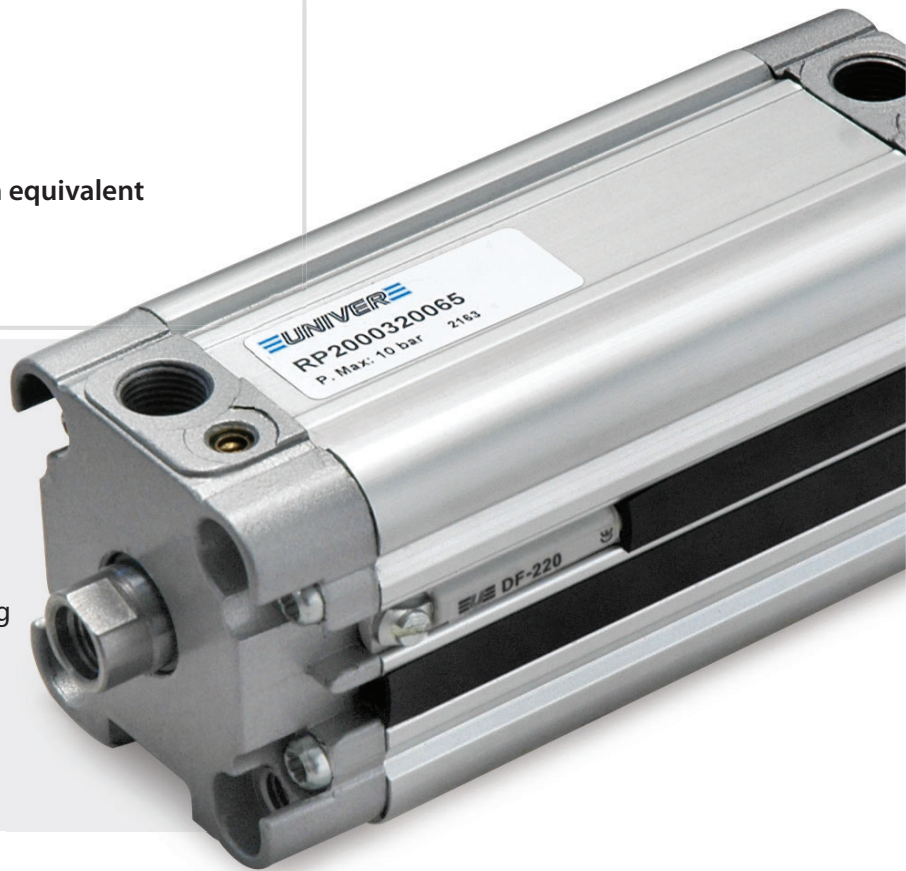
Available in standard version and non-rotating version with **UNIVER Original** octagonal tube



Standard



Octagonal



RP/RM

RP (UNITOP RU-2/7)
 $\varnothing 16 \div 63$ mm



RM (ISO 21287)
 $\varnothing 16 \div 100$ mm



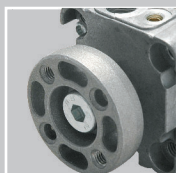
RP210

With anti-rotation guides
 $\varnothing 16 \div 63$ mm



RO/RN

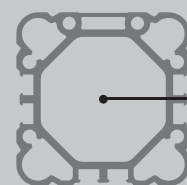
RO (UNITOP RU-2/7)
 $\varnothing 16 \div 63$ mm



RN (ISO 21287)
 $\varnothing 16 \div 63$ mm



Non-rotating (octagonal tube) version
 Max load (Nm)



\varnothing	Nm
16	0,5
20	0,8
25	1
32	2
40	3
50	5
63	8

KIT Assembly Kit
 available for all series



CHARACTERISTICS

Ambient temperature	-20 ÷ 80 °C
Fluid	filtered air, with or without lubrication
Working pressure	1,5 ÷ 10 bar
End-caps	die-cast zamak (Ø 16 ÷ 25 mm) die-cast aluminium (Ø 32 ÷ 63 mm)
Barrel	anodized aluminium
Piston	aluminium
Guide slide	acetalic resin
Piston rod	chromium-plated steel, stainless steel upon request
Piston seal	NBR
Guide bush for piston rod	acetalic resin
Shock absorber seals	NBR
Cushionings	adjustable on both sides (UNIVER Original standard supplied)
Magnet	plasto-ferrite (standard supplied)
Other available versions	tandem, two-position tandem, opposed, with common piston rod (upon request)



CODIFICATION KEY

R	P	2	0	0	0	3	2	0	0	2	5		
1	2	3	4	5	6	7							

1 Series	2 Type	3 Version	4 Bore (mm)
RP = Ø 16÷63 mm - UNITOP Compact Cylinders	1 = Stainless steel female piston rod 2 = Chromium-plated steel female piston rod Upon request 3 = Stainless steel male piston rod (Ø40÷63) 4 = Chromium-plated steel male piston rod (Ø40÷63)	00 = D.A. Standard version 01 = D.A. Through piston rod 10 = D.A. Non-rotating guided piston rod 11 = D.A. Non-rotating guided through piston rod 20 = D.A. Long piston (Ø32÷63) 60 = S.A. Retracted piston rod 70 = S.A. Extended piston rod D.A. = Double acting S.A. = Single acting	016 = Ø16 020 = Ø20 025 = Ø25 032 = Ø32 040 = Ø40 050 = Ø50 063 = Ø63

5 Stroke (mm)	6 Option	7 ATEX option
Single acting 0005 - 0010 (Ø16÷25) 0005 - 0010 - 0015 - 0020 - 0025 (Ø32÷63) Double acting 0005 - 0010 - 0015 - 0020 - 0025 - 0030 - 0040 0050 - 0060 - 0080	Max standard stroke 0040 (Ø16) 0050 (Ø20-25) 0080 (Ø32÷63) Max stroke with non-rotating guided piston rod (upon request) 0100 (Ø16) 0200 (Ø20-25) 0400 (Ø32-40) 0500 (Ø50-63)	C = With flange for versions: 100-101-120-160-170 200-201-220-260-270 H = Hollow piston rod only for through piston rod versions without flange X = Atex (upon request) See ATEX Catalogue for types and versions

For high temperature applications please contact our Sales Office

FIXING ELEMENTS AND ACCESSORIES

Ø	Flange for female piston rod	Rear male hinge	Rear female hinge with pin	Counter hinge 90°	Front/rear flange	Angle bracket	Intermediate hinge	Centering adaptor ring	Hinge support	DF sensor and DHF covering strip	Cable clamping for DF sensor
16			-	-			-	-	-		
20	RPF-28016	RPF-11016	-	-	RPF-12016	RPF-13016	-	-	-		
25	RPF-28020	RPF-11020	-	-	RPF-12020	RPF-13020	-	-	-		
25	RPF-28025	RPF-11025	-	-	RPF-12025	RPF-13025	-	-	-		
32	RPF-28032	KF-11032	KF-10032A	KF-19032	KF-12032	KF-13032	KDF-14032	RSF-09032	KF-41032		
40	RPF-28040	-	RPF-10040A	KF-19040	RPF-12040	RPF-13040	RPF-14040	RSF-09040	KF-41040050		
50	RPF-28050	-	RPF-10050A	KF-19050	RPF-12050	RPF-13050	RPF-14050	RSF-09050	KF-41040050		
63	RPF-28063	-	RPF-10063A	KF-19063	RPF-12063	RPF-13063	RPF-14063	RSF-09063	KF-41063080		

1
CHARACTERISTICS

Ambient temperature	-20 ÷ 80 °C
Fluid	filtered air, with or without lubrication
Working pressure	1,5 ÷ 10 bar
End-caps	die-cast zamak (Ø 16 ÷ 25 mm) die-cast aluminium (Ø 32 ÷ 100 mm)
Barrel	anodized aluminium
Piston	aluminium
Guide slide	acetalic resin
Piston rod	chromium-plated steel, stainless steel upon request
Piston seal	NBR
Guide bush for piston rod	acetalic resin
Shock absorber seals	NBR
Cushionings	adjustable on both sides (UNIVER Original standard supplied)
Magnet	plasto-ferrite (standard supplied)
Other available versions	tandem, two-position tandem, opposed tandem, with common piston rod (upon request)


CODIFICATION KEY

R	M	3	0	0	0	3	2	0	0	2	5		
1	2	3	4	5	6	7							

1 Series	2 Type	3 Version	4 Bore (mm)	5 Stroke (mm)	6 Option	7 ATEX option	
RM = Ø 16÷100 mm - ISO 21287 Compact Cylinders	3 = Stainless steel male piston rod 4 = Chromium-plated steel male piston rod Upon request 1 = Stainless steel female piston rod (Ø40÷100) 2 = Chromium-plated steel female piston rod (Ø 40÷100)	00 = D.A. Standard version 01 = D.A. Through piston rod 20 = D.A. Long piston (Ø32÷63) 60 = S.A. Retracted piston rod 70 = S.A. Extended piston rod	016 = Ø16 050 = Ø50 020 = Ø20 063 = Ø63 025 = Ø25 080 = Ø80 032 = Ø32 100 = Ø100 040 = Ø40	Single acting 0005 - 0010 (Ø16÷25) 0005 - 0010 - 0015 - 0020 - 0025 (Ø32÷100) Double acting 0005 - 0010 - 0015 - 0020 - 0025 - 0030 0040 - 0050 - 0060 - 0080	Max standard stroke 0040 (Ø16) 0050 (Ø20-25) 0080 (Ø32÷63)	H = Hollow piston rod only for through piston rod versions without flange	D.A. = Double acting S.A. = Single acting X = Atex (upon request) See ATEX Catalogue for types and versions

For high temperature applications please contact our Sales Office

FIXING ELEMENTS AND ACCESSORIES

Ø	Female fork with clips	Articulated self-lubricating fork	Fork with axially mounted articulated pin	Fork with angle mounted articulated pin	Floating joint	Centering adaptor ring	Female rear hinge with pin	Counter hinge 90° (CETOP)	Counter hinge 90°	Counter hinge 90° (CNOMO)	Narrow female hinge with pin
16											
20	MF-15012	MF-17012	MF-22016	MF-23012	MF-24012	-	-	-	-	-	-
25	MF-15020	MF-17020	MF-22020	MF-23020	MF-24020	-	-	-	-	-	-
32	KF-15032	KF-17032	KF-22025	KF-23025	KF-24032	RSF-09032	KF-10032A	KF-19032CTA	KF-19032	KF-19032CN	KF-10032AS
40	KF-15032	KF-17032	KF-22025	KF-23025	KF-24032	RSF-09040	KF-10040A	KF-19040CTA	KF-19040	KF-19040050CN	KF-10040AS
50	KF-15040	KF-17040	KF-22040	KF-23040	KF-24040	RSF-09050	KF-10050A	KF-19050CTA	KF-19050	KF-19040050CN	KF-10050AS
63	KF-15040	KF-17040	KF-22040	KF-23040	KF-24040	RSF-09063	KF-10063A	KF-19063CTA	KF-19063	KF-19063080CN	KF-10063AS
80	KF-15050	KF-17050	KF-22050	KF-23050	KF-24050	RSF-09080	KF-10080A	KF-19080CTA	KF-19080	KF-19063080CN	KF-10080AS
100	KF-15050	KF-17050	KF-22050	KF-23050	KF-24050	RSF-09100	KF-10100A	KF-19100CTA	KF-19100	KF-19100125CN	KF-10100AS
Ø	Articulated counter hinge	Articulated rear male hinge	Rear male hinge	Front/rear flange	Angle bracket	Front/rear hinge with floating pin	Hinge support	ISO intermediate hinge	DF sensor and DHF covering strip	Cable clamping for DF sensor	
16											
20	-	-	RPF-11016	RPF-12016	RPF-13016	-	-	-	DF DHF-0020100	DF-001	
25	-	-	RPF-11020	RPF-12020	RPF-13020	-	-	-			
32	-	-	RPF-11025	RPF-12025	RPF-13025	-	-	-			
40	KF-190325C	KF-110325	KF-11032	KF-12032	KF-13032	KF-14032AP	KF-41032	KDF-14032			
50	KF-190405C	KF-110405	KF-11040	KF-12040	KF-13040	KF-14040AP	KF-41040050	RPF-14040			
63	KF-190505C	KF-110505	KF-11050	KF-12050	KF-13050	KF-14050AP	KF-41040050	RPF-14050			
80	KF-190635C	KF-110635	KF-11063	KF-12063	KF-13063	KF-14063AP	KF-41063080	RPF-14063			
100	KF-190805C	KF-110805	KF-11080	KF-12080	KF-13080	KF-14080AP	KF-41063080	KDF-14080			
100	KF-191005C	KF-111005	KF-11100	KF-12100	KF-13100	KF-14100AP	KF-41100125	KDF-14100			

CHARACTERISTICS

Ambient temperature	-20 ÷ 80 °C
Fluid	filtered air, with or without lubrication
Working pressure	1,5 ÷ 10 bar
End-caps	die-cast zamak (Ø 16 ÷ 25 mm) die-cast aluminium (Ø 32 ÷ 63 mm)
Barrel	anodized aluminium
Piston	aluminium
Guide slide	acetalic resin
Piston rod	chromium-plated steel, stainless steel upon request
Piston seal	NBR
Guide bush for piston rod	acetalic resin
Shock absorber seals	NBR
Cushionings	adjustable on both sides (UNIVER Original standard supplied)
Magnet	plasto-ferrite (standard supplied)
Other available versions	tandem, two-position tandem, opposed tandem, with common piston rod (upon request)



CODIFICATION KEY

R	O	2	0	0	0	3	2	0	0	2	5		
1	2	3	4				5			6	7		

1 Series RO = Ø 16÷63 mm - UNITOP Compact Cylinders octagonal tube 	2 Type 1 = Stainless steel female piston rod with flange 2 = Chromium-plated steel female piston rod with flange Male piston rod upon request (Ø40÷63)	3 Version 00 = D.A. Standard version 01 = D.A. Through piston rod 20 = D.A. Long piston (Ø32÷63) D.A. = Double acting
--	--	--

4 Bore (mm) 016 = Ø16 020 = Ø20 025 = Ø25 032 = Ø32 040 = Ø40 050 = Ø50 063 = Ø63	5 Stroke (mm) 0005 - 0010 - 0015 - 0020 - 0025 0030 - 0040 - 0050 - 0060 - 0080 Max standard stroke 0040 (Ø16) 0050 (Ø20-25) 0080 (Ø32÷63)	6 Option H = Hollow piston rod only for through piston rod versions without flange	7 ATEX option X = Atex (upon request) See ATEX Catalogue for types and versions
---	--	--	--

FIXING ELEMENTS AND ACCESSORIES

Ø	Rear male hinge	Rear female hinge with pin	Counter hinge 90°	Front/rear flange	Angle bracket	Intermediate hinge	Centering adaptor ring	Hinge support	DF sensor and DHF covering strip	Cable clamping for DF sensor
16		-	-	RPF-12016	RPF-13016	-	-	-	DF DHF-0020100	DF-001
20		-	-	RPF-12020	RPF-13020	-	-	-		
25		-	-	RPF-12025	RPF-13025	-	-	-		
32		KF-10032A	KF-19032	KF-12032	KF-13032	KDF-14032	RSF-09032	KF-41032		
40	-	RPF-10040A	KF-19040	RPF-12040	RPF-13040	RPF-14040	RSF-09040	KF-41040050		
50	-	RPF-10050A	KF-19050	RPF-12050	RPF-13050	RPF-14050	RSF-09050	KF-41040050		
63	-	RPF-10063A	KF-19063	RPF-12063	RPF-13063	RPF-14063	RSF-09063	KF-41063080		

1

CHARACTERISTICS

Ambient temperature	-20 ÷ 80 °C
Fluid	filtered air, with or without lubrication
Working pressure	1,5 ÷ 10 bar
End-caps	die-cast zamak (Ø16÷25) die-cast aluminium (Ø32÷63)
Barrel	anodized aluminium
Piston	aluminium
Guide slide	acetalic resin
Piston rod	chromium-plated steel, stainless steel upon request
Piston seal	NBR
Guide bush for piston rod	acetalic resin
Shock absorber seals	NBR
Cushionings	adjustable on both sides (UNIVER Original standard supplied)
Magnet	plasto-ferrite (standard supplied)
Other available versions	tandem, two-position tandem, opposed tandem, with common piston rod (upon request)



CODIFICATION KEY

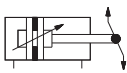
R	N	3	0	0	0	3	2	0	0	2	5		
1	2	3	4	5	6	7							

1 Series	2 Type	3 Version
-----------------	---------------	------------------

RN = Ø 16÷63 mm - ISO 21287
Compact Cylinders octagonal tube

3 = Stainless steel male piston rod
4 = Chromium-plated steel male piston rod

00 = D.A. Standard version
01 = D.A. Through piston rod
20 = D.A. Long piston (Ø32÷63)



Female piston rod upon request (Ø40÷63)

D.A. = Double acting

4 Bore (mm)	5 Stroke (mm)	6 Option	7 ATEX option
--------------------	----------------------	-----------------	----------------------

016 = Ø16
020 = Ø20
025 = Ø25
032 = Ø32
040 = Ø40
050 = Ø50
063 = Ø63

0005 - 0010 - 0015 - 0020 - 0025
0030 - 0040 - 0050 - 0060 - 0080
Max standard stroke
0040 (Ø16)
0050 (Ø20-25)
0080 (Ø32÷63)

H = Hollow piston rod only for through piston rod versions without flange

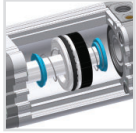
X = Atex (upon request)

See ATEX Catalogue for types and versions

FIXING ELEMENTS AND ACCESSORIES

Ø	Female fork with clips	Articulated self-lubricating fork	Fork with axially mounted articulated pin	Fork with angle mounted articulated pin	Floating joint	Centering adaptor ring	Rear female hinge with pin	Counter hinge 90° (CETOP)	Counter hinge 90°	Counter hinge 90° (CNOMO)	Narrow female hinge with pin
16						-					
20	MF-15012	MF-17012	MF-22016	MF-23012	MF-24012	-	-	-	-	-	-
25	MF-15020	MF-17020	MF-22020	MF-23020	MF-24020	-	-	-	-	-	-
32	KF-15032	KF-17032	KF-22025	KF-23025	KF-24032	RSF-09032	KF-10032A	KF-19032CTA	KF-19032	KF-19032CN	KF-10032AS
40	KF-15032	KF-17032	KF-22025	KF-23025	KF-24032	RSF-09040	KF-10040A	KF-19040CTA	KF-19040	KF-19040050CN	KF-10040AS
50	KF-15040	KF-17040	KF-22040	KF-23040	KF-24040	RSF-09050	KF-10050A	KF-19050CTA	KF-19050	KF-19040050CN	KF-10050AS
63	KF-15040	KF-17040	KF-22040	KF-23040	KF-24040	RSF-09063	KF-10063A	KF-19063CTA	KF-19063	KF-19063080CN	KF-10063AS

Ø	Articulated counter hinge	Articulated rear male hinge	Rear male hinge	Front/rear flange	Angle bracket	Front/rear hinge with floating pin	Hinge support	ISO Intermediate hinge	DF sensor and DHF covering strip	Cable clamping for DF sensor
16										
20	-	-	RPF-11016	RPF-11016	RPF-11016	-	-	-	DF DHF-0020100	DF-001
25	-	-	RPF-11020	RPF-11020	RPF-11020	-	-			
32	-	-	RPF-11025	RPF-11025	RPF-11025	-	-			
40	KF-19032SC	KF-11032S	KF-11032	KF-12032	KF-13032	KF-14032AP	KF-41032	KDF-14032		
50	KF-19040SC	KF-11040S	KF-11040	KF-12040	KF-13040	KF-14040AP	KF-41040050	RPF-14040		
63	KF-19050SC	KF-11050S	KF-11050	KF-12050	KF-13050	KF-14050AP	KF-41040050	RPF-14050		
63	KF-19063SC	KF-11063S	KF-11063	KF-12063	KF-13063	KF-14063AP	KF-41063080	RPF-14063		



Adjustable pneumatic cushioning

UNIVER Original since 1999

- No change in dimensions comparing to an equivalent cylinder without cushionings
- Standard supplied for all models

STRONG

Oversized guide and piston rods

ISO 15552

Interaxes, centering diameters and piston rods complying with ISO 15552 standards



RS

Ø 32 ÷ 100 mm



RS210

With anti-rotation guides Ø 32 ÷ 100 mm

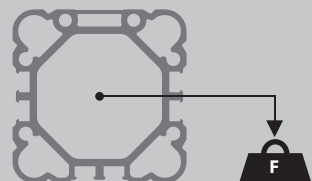


RQ

Ø 32 ÷ 63 mm

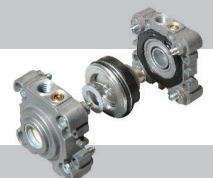


Non-rotating version (octagonal tube)
Max load (Nm)



Ø	Nm
32	2
40	3
50	5
63	8

KIT Assembly Kit
available for all series



1
CHARACTERISTICS

Ambient temperature	-20 ÷ 80 °C
Fluid	filtered air, with or without lubrication
Working pressure	1,5 ÷ 10 bar
End-caps	die-cast aluminium
Barrel	anodized aluminium
Piston	aluminium
Guide slide	acetalic resin
Piston rod	chromium-plated steel, stainless steel upon request
Piston seal	NBR
Guide bush for piston rod	acetalic resin
Shock absorber seals	NBR
Cushionings	adjustable on both sides (UNIVER Original standard supplied)
Magnet	plasto-ferrite (standard supplied)
Other versions available	tandem, two-position tandem, opposed tandem, with common piston rod (upon request)


CODIFICATION KEY

R	S	2	0	0	0	3	2	0	0	2	5		
1	2	3	4	5	6	7							

1 Series	2 Type	3 Version
RS = Ø 32÷100 mm STRONG Compact Cylinders	1 = Stainless steel female piston rod 2 = Chromium-plated steel female piston rod 3 = Stainless steel male piston rod 4 = Chromium-plated steel male piston rod	For type 1 - 2 00 = D.A. Standard version 01 = D.A. Through piston rod 10 = D.A. Non-rotating guided piston rod (Ø32÷63) 11 = D.A. Non-rotating guided through piston rod (Ø32÷63) 20 = D.A. Long piston (Ø32÷63) 60 = S.A. Retracted piston rod 70 = S.A. Extended piston rod
		For type 3 - 4 00 = D.A. Standard version 01 = D.A. Through piston rod 20 = D.A. Long piston (Ø32÷63) 60 = S.A. Retracted piston rod 70 = S.A. Extended piston rod
		D.A. = Double acting S.A. = Single acting

4 Bore (mm)	5 Stroke (mm)	6 Option	7 ATEX Option
032 = Ø32 040 = Ø40 050 = Ø50 063 = Ø63 080 = Ø80 100 = Ø100	Single acting 0005 - 0010 - 0015 - 0020 - 0025 Double acting 0005 - 0010 - 0015 - 0020 - 0025 - 0030 - 0040 - 0050 - 0060 - 0080 Max standard stroke 0080 (Ø32÷100)	Max stroke with long piston (upon request) 0800 (Ø32-40) 1000 (Ø50-63) Max stroke with non-rotating guided piston rod (upon request) 0400 (Ø32-40) 0500 (Ø50) 0800 (Ø63)	X = ATEX (upon request) See ATEX Catalogue for types and versions
		H = Hollow piston rod only for through piston rod versions without flange G = Preset for locking unit only for D.A. cylinders with chromium-plated steel piston rod C = With flange for versions: 100-101-120-160-170 200-201-220-260-270	

For high temperature applications please contact our Sales Office

FIXING ELEMENTS AND ACCESSORIES

Ø	Female fork with clips	Articulated self-lubricating fork	Fork with axially mounted articulated pin	Fork with angle mounted articulated pin	Floating joint	Flange for female piston rod	Centering adaptor ring	Female rear hinge with pin	Counter hinge 90° (CETOP)	Counter hinge 90°	Counter hinge 90° (CNOMO)
32											
40	KF-15032	KF-17032	KF-22025	KF-23025	KF-24032	RPF-28032	RSF-09032	KF-10032A	KF-19032CTA	KF-19032	KF-19032CN
50	KF-15040	KF-17040	KF-22040	KF-23040	KF-24040	RPF-28040	RSF-09040	KF-10040A	KF-19040CTA	KF-19040	KF-19040050CN
63	KF-15050	KF-17050	KF-22050	KF-23050	KF-24050	RPF-28050	RSF-09050	KF-10050A	KF-19050CTA	KF-19050	KF-19040050CN
80	KF-15063	KF-17063	KF-22063	KF-23063	KF-24063	RPF-28063	RSF-09063	KF-10063A	KF-19063CTA	KF-19063	KF-19063080CN
100	KF-15080	KF-17080	KF-22080	KF-23080	KF-24080	-	RSF-09080	KF-10080A	KF-19080CTA	KF-19080	KF-19063080CN
	KF-15080	KF-17080	KF-22080	KF-23080	KF-24080	-	RSF-09100	KF-10100A	KF-19100CTA	KF-19100	KF-19100125CN
Ø	Narrow female hinge with pin	Articulated counter hinge	Articulated rear male hinge	Rear male hinge	Front/rear flange	Angle bracket	Front/rear hinge with floating pin	Hinge support	ISO Intermediate hinge	DF sensor and DHF covering strip	Cable clamping for DF sensor
32											
40	KF-10032AS	KF-19032SC	KF-11032S	KF-11032	KF-12032	KF-13032	KF-14032AP	KF-41032	KDF-14032		
50	KF-10040AS	KF-19040SC	KF-11040S	KF-11040	KF-12040	KF-13040	KF-14040AP	KF-41040050	RPF-14040		
63	KF-10050AS	KF-19050SC	KF-11050S	KF-11050	KF-12050	KF-13050	KF-14050AP	KF-41040050	RPF-14050		
80	KF-10063AS	KF-19063SC	KF-11063S	KF-11063	KF-12063	KF-13063	KF-14063AP	KF-41063080	RPF-14063		
100	KF-10080AS	KF-19080SC	KF-11080S	KF-11080	KF-12080	KF-13080	KF-14080AP	KF-41063080	KDF-14080		
	KF-10100AS	KF-19100SC	KF-11100S	KF-11100	KF-12100	KF-13100	KF-14100AP	KF-41100125	KDF-14100		
										DF DHF-0020100	DF-001

CHARACTERISTICS

Ambient temperature	-20 ÷ 80 °C
Fluid	filtered air, with or without lubrication
Working pressure	1,5 ÷ 10 bar
End-caps	die-cast aluminium
Barrel	anodized aluminium
Piston	aluminium
Guide slide	acetalic resin
Piston rod	chromium-plated steel, stainless steel upon request
Piston seal	NBR
Guide bush for piston rod	acetalic resin
Shock absorber seals	NBR
Cushionings	adjustable on both sides (UNIVER Original standard supplied)
Magnet	plasto-ferrite (standard supplied)
Other available versions	tandem, two-position tandem, opposed tandem, with common piston rod (upon request)


CODIFICATION KEY

R	Q	2	0	0	0	3	2	0	0	2	5		
1	2	3	4	5	6	7							

1 Series	2 Type	3 Version
-----------------	---------------	------------------

RQ = Ø 32÷63 mm - STRONG
Compact Cylinders octagonal tube

- 1 = Stainless steel female piston rod with flange
 2 = Chromium-plated steel female piston rod with flange
 3 = Stainless steel male piston rod
 4 = Chromium-plated steel male piston rod

- 00 = D.A. Standard version
 01 = D.A. Through piston rod
 20 = D.A. Long piston



D.A. = Double acting

4 Bore (mm)	5 Stroke (mm)	6 Option	7 ATEX Option
--------------------	----------------------	-----------------	----------------------

- 032 = Ø32
 040 = Ø40
 050 = Ø50
 063 = Ø63

- Double acting**
 0005 - 0010 - 0015 - 0020 - 0025
 0030 - 0040 - 0050 - 0060 - 0080

Max standard stroke
 0080

Max stroke with long piston (upon request)
 0800 (Ø32-40)
 1000 (Ø50-63)

- H = Hollow piston rod only for through piston rod versions without flange
 G = Preset for locking unit only with chromium-plated steel piston rod

- X = Atex (upon request)
 See ATEX Catalogue for types and versions

FIXING ELEMENTS AND ACCESSORIES

Ø	Female fork with clips	Articulated self-lubricating fork	Fork with axially mounted articulated pin	Fork with angle mounted articulated pin	Floating joint	Centering adaptor ring	Female rear hinge with pin	Counter hinge 90° (CETOP)	Counter hinge 90°	Counter hinge 90° (CNOMO)	Narrow female hinge with pin
32											
	KF-15032	KF-17032	KF-22025	KF-23025	KF-24032	RSF-09032	KF-10032A	KF-19032CTA	KF-19032	KF-19032CN	KF-10032AS
40											
	KF-15040	KF-17040	KF-22040	KF-23040	KF-24040	RSF-09040	KF-10040A	KF-19040CTA	KF-19040	KF-19040050CN	KF-10040AS
50											
	KF-15050	KF-17050	KF-22050	KF-23050	KF-24050	RSF-09050	KF-10050A	KF-19050CTA	KF-19050	KF-19040050CN	KF-10050AS
63											
	KF-15050	KF-17050	KF-22050	KF-23050	KF-24050	RSF-09063	KF-10063A	KF-19063CTA	KF-19063	KF-19063080CN	KF-10063AS

Ø	Articulated counter hinge	Articulated rear male hinge	Rear male hinge	Front, rear flange	Angle bracket	Front / rear hinge	Hinge support	ISO Intermediate hinge	DF sensor and DHF covering strip	Cable clamping for DF sensor
32										
	KF-19032SC	KF-11032S	KF-11032	KF-12032	KF-13032	KF-14032AP	KF-41032	KDF-14032	DF DHF-0020100	DF-001
40										
	KF-19040SC	KF-11040S	KF-11040	KF-12040	KF-13040	KF-14040AP	KF-41040050	RPF-14040		
50										
	KF-19050SC	KF-11050S	KF-11050	KF-12050	KF-13050	KF-14050AP	KF-41040050	RPF-14050		
63										
	KF-19063SC	KF-11063S	KF-11063	KF-12063	KF-13063	KF-14063AP	KF-41063080	RPF-14063		

PM/PK/PRM | Stainless steel Cylinders

The UNIVER **PM/PRM/PK** cylinders, in **AISI304/316** stainless steel, are suitable for high corrosion environments, such as in food, chemical, shipbuilding and pharmaceutical industries.

In compliance with **ISO 6432**, **15552** and **21287** standards these cylinders are interchangeable with products with the same features.

PK/PRM FDA APPROVED PISTON SEALS (STANDARD SUPPLIED)



PM

Ø 16 ÷ 25 mm - ISO 6432



PM

Ø 32 ÷ 63 mm



PK

Ø 32 ÷ 125 mm - ISO 15552



PRM

Ø 20 ÷ 100 mm - ISO 21287



CHARACTERISTICS

Ambient temperature	0 ÷ 80 °C (-20 °C with dry air)
Fluid	compressed air, filtered, not lubricated
Working pressure	1 ÷ 10 bar
End-caps	stainless steel AISI 304
Barrel	stainless steel AISI 304
Piston	brass
Piston rod	stainless steel AISI 316
Piston seals	polyurethane
Guide bush for piston rod	sintered brass
Shock absorber seals	neoprene
Cushionings	adjustable on both sides (Ø 25)



CODIFICATION KEY

P	M	3	0	0	0	1	6	0	0	1	0	M	
1	2	3	4		5			6	7				

1 Series	2 Type	3 Version
PM = Ø 16 ÷ 25 mm - ISO 6432 Stainless steel Pneumatic Cylinders	3 = Male piston rod	00 = D.A. Standard 01 = D.A. Through-rod 50 = D.A. With adjustable cushionings (Ø25) 51 = D.A. Through-rod with adjustable cushionings (Ø25)

D.A. = Double acting

4 Bore (mm)	5 Stroke (mm)	6 Magnetic	7 ATEX option
016 = Ø16 020 = Ø20 025 = Ø25	0010 = 10 0160 = 160 0025 = 25 0200 = 200 0050 = 50 0250 = 250 0080 = 80 0320 = 320 0100 = 100 0400 = 400 0125 = 125 0500 = 500	M = Magnetic version standard supplied	X = ATEX (upon request) See ATEX Catalogue for types and versions

Version with high temperature seals (Max 120°C) available upon request.

FIXING ELEMENTS AND ACCESSORIES

Ø	Female fork with pin	Articulated self-lubricating fork	Angle bracket (MS3)	Flange (MF8)	Rear female hinge	Nut for end-cap	Nut for piston	DF bracket and adapter	DF sensor
16	MF-15012PI	MF-17012I	MF-13012I	MF-12012I	MF-21012I	MF-20012I	MF-16012I	DH-P016020DFI	DF-P700L06
20	MF-15020PI	MF-17020I	MF-13020I	MF-12020I	MF-21020I	MF-20020I	MF-16020I	DH-P016020DFI	
25	KF-15032PI	KF-17032I	MF-13020I	MF-12020I	MF-21020I	MF-20020I	KF-16032I	DH-P025032DFI	

1

CHARACTERISTICS

Ambient temperature	0 ÷ 80 °C (-20°C with dry air)
Fluid	compressed air, filtered, not lubricated
Working pressure	1 ÷ 10 bar
End-caps	stainless steel AISI 304
Barrel	stainless steel AISI 304
Piston	aluminium
Guide slide	PBT+PTFE
Piston rod	stainless steel AISI 316
Piston seals	polyurethane
Guide bush for piston rod	sintered brass
Cushionings	neoprene



CODIFICATION KEY

P	M	3	0	0	0	3	2	0	0	5	0	M
1	2	3	4		5			6				

1 Series	2 Type	3 Version	4 Bore (mm)
PM = Ø 32 ÷ 63 mm - Stainless steel Pneumatic Cylinders	3 = Male piston rod	00 = D.A. Standard 01 = D.A. Through piston rod	032 = Ø32 040 = Ø40 050 = Ø50 063 = Ø63
		D.A. = Double acting	

5 Stroke (mm)	6 Magnetic
0010 = 10 0160 = 160 0025 = 25 0200 = 200 0050 = 50 0250 = 250 0080 = 80 0320 = 320 0100 = 100 0400 = 400 0125 = 125 0500 = 500	M = Magnetic version (standard supplied)

Version with high temperature seals (Max 120°C) available upon request.

FIXING ELEMENTS AND ACCESSORIES

Ø	Female fork with pin	Articulated self-lubricating fork	Angle bracket (MS3)	Rear female hinge	Pin (MF8)	Nut for piston	Nut for end-cap	DF bracket and adapter	DF sensor
32	KF-15032PI	KF-17032I	MF-13032I	MF-21032I	MF-18032I	KF-16032I	MF-20032I	DH-P025032DFI	DF-P700L06
40	KF-15040PI	KF-17040I	MF-13040I	MF-21040I	MF-18040I	KF-16040I	MF-20040I	DH-P040DFI	
50	KF-15050PI	KF-17050I	MF-13050I	MF-21050I	MF-18050I	KF-16050I	MF-20050I	DH-P050DFI	
63	KF-15050PI	KF-17050I	MF-13063I	MF-21063I	MF-18063I	KF-16050I	MF-20063I	DH-P063DFI	

CHARACTERISTICS

Ambient temperature	0 ÷ 80°C (-20 °C with dry air)
Fluid	0 ÷ 150°C (with high temperature seals) compressed air, filtered, not lubricated
Working pressure	1 ÷ 10 bar
End-caps	stainless steel AISI 316
Barrel	stainless steel AISI 316
Piston	die-cast aluminium
Guide slide	PBT+PTFE
Piston rod	stainless steel AISI 316
Piston seal	polyurethane (FDA Approved)
Guide bush for piston rod	sintered brass
Cushionings	adjustable on both sides



CODIFICATION KEY

P	K	3	0	0	0	3	2	0	0	2	5	M	
1	2	3	4	5	6	7							

1 Series	2 Type	3 Version	4 Bore (mm)
PK = Ø 32÷125 mm - ISO 15552 Stainless steel Pneumatic Cylinders	3 = Male piston rod	00 = D.A. Standard 01 = D.A. Through piston rod	032 = Ø32 080 = Ø80 040 = Ø40 100 = Ø100 050 = Ø50 125 = Ø125 063 = Ø63

D.A. = Double acting

5 Stroke (mm)	6 Magnetic	7 ATEX option
0025 = 25 0150 = 150 0320 = 320 0700 = 700 0050 = 50 0160 = 160 0350 = 350 0800 = 800 0075 = 75 0175 = 175 0400 = 400 0900 = 900 0080 = 80 0200 = 200 0450 = 450 1000 = 1000 0100 = 100 0250 = 250 0500 = 500 0125 = 125 0300 = 300 0600 = 600	M = Magnetic version (standard supplied)	X = Atex (upon request) See ATEX Catalogue for types and versions

Version with high temperature seals (Max 150°C) available upon request.

FIXING ELEMENTS AND ACCESSORIES

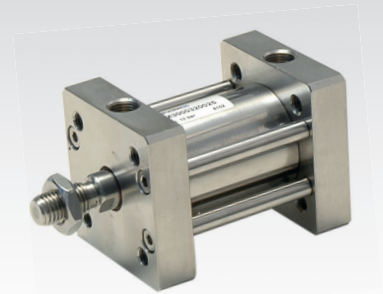
Ø	Female fork with pin	Articulated self-lubricating fork	Front/rear flange	Angle bracket	Female hinge with pin	Rear male hinge	Counter hinge 90°	Articulated rear male hinge	Narrow female hinge with pin	Intermediate hinge for tie-rods
32										
40	KF-15032PI	KF-17032I	KF-12032I	KF-13032I	KF-10032AI	KF-11032I	KF-19032CTAI	KF-11032SI	KF-10032ASI	KF-14032TI
50	KF-15040PI	KF-17040I	KF-12040I	KF-13040I	KF-10040AI	KF-11040I	KF-19040CTAI	KF-11040SI	KF-10040ASI	KF-14040TI
63	KF-15050PI	KF-17050I	KF-12050I	KF-13050I	KF-10050AI	KF-11050I	KF-19050CTAI	KF-11050SI	KF-10050ASI	KF-14050TI
80	KF-15080PI	KF-17080I	KF-12080I	KF-13080I	KF-10080AI	KF-11080I	KF-19080CTAI	KF-11080SI	KF-10080ASI	KF-14080TI
100	KF-15080PI	KF-17080I	KF-12100I	KF-13100I	KF-10100AI	KF-11100I	KF-19100CTAI	KF-11100SI	KF-10100ASI	KF-14100TI
125	KF-15125PI	KF-17125I	KF-12125I	KF-13125I	KF-10125AI	KF-11125I	KF-19125CTAI	KF-11125SI	KF-10125ASI	KF-14125TI

Ø	Hinge support	Nut for piston	DF bracket and adapter	DF sensor
32				
40	KF-41032I	KF-16032I	DH-P025032DFI	DF-P700L06
50	KF-41040050I	KF-16040I	DH-P040DFI	
63	KF-41040050I	KF-16050I	DH-P050DFI	
80	KF-41063080I	KF-16050I	DH-P063DFI	
100	KF-41063080I	KF-16080I	DH-P080DFI	
125	KF-41100125I	KF-16080I	DH-P100DFI	
125	KF-41100125I	KF-16125I	DH-P125DFI	

1

CHARACTERISTICS

Ambient temperature	0 ÷ 80°C (-20 °C with dry air)
Fluid	compressed air, filtered, not lubricated
Working pressure	1 ÷ 10 bar (double acting) 2 ÷ 10 bar (single acting)
End-caps	stainless steel AISI 316
Barrel	Ø20-25 stainless steel AISI 304, Ø32-100 stainless steel AISI 316
Piston	aluminium
Guide slide	PBT+PTFE
Piston rod	stainless steel AISI 316
Piston seal	polyurethane (FDA Approved)
Guide bush for piston rod	technopolymer



CODIFICATION KEY

P	R	M	3	0	0	0	3	2	0	0	2	5	M	
---	---	---	---	---	---	---	---	---	---	---	---	---	---	--

1	2	3	4	5	6	7
---	---	---	---	---	---	---

1 Series	2 Type	3 Version	4 Bore (mm)
PRM = Ø 20÷100 mm - ISO 21287 Stainless steel Pneumatic Cylinders	1 = Female piston rod 3 = Male piston rod	00 = D.A. Standard 01 = D.A. Through piston rod	020 = Ø20 050 = Ø50 025 = Ø25 063 = Ø63 032 = Ø32 080 = Ø80 040 = Ø40 100 = Ø100

D.A. = Double acting

5 Stroke (mm)	6 Magnetic	7 ATEX option
0010 = 10 0160 = 160 0025 = 25 0200 = 200 0050 = 50 0250 = 250 0075 = 75 0300 = 300 0100 = 100 0350 = 350 0125 = 125 0400 = 400	M = Magnetic version (standard supplied)	X = ATEX (upon request) See ATEX Catalogue for types and versions

Version with high temperature seals (Max 150°C) available upon request.

FIXING ELEMENTS AND ACCESSORIES

Ø	Female fork with pin	Articulated self-lubricating fork	Front/rear flange	Angle bracket	Female hinge with pin	Rear male hinge	Counter hinge 90°	Articulated rear male hinge	Narrow female hinge with pin	Nut for piston
20										
	MF-15020PI	MF-17020I	-	-	-	-	-	-	-	MF-16020I
25	MF-15020PI	MF-17020I	-	-	-	-	-	-	-	MF-16020I
32	KF-15032PI	KF-17032I	KF-12032I	KF-13032I	KF-10032AI	KF-11032I	KF-19032CTAI	KF-11032SI	KF-10032ASI	KF-16032I
40	KF-15032PI	KF-17032I	KF-12040I	KF-13040I	KF-10040AI	KF-11040I	KF-19040CTAI	KF-11040SI	KF-10040ASI	KF-16040I
50	KF-15040PI	KF-17040I	KF-12050I	KF-13050I	KF-10050AI	KF-11050I	KF-19050CTAI	KF-11050SI	KF-10050ASI	KF-16050I
63	KF-15040PI	KF-17040I	KF-12063I	KF-13063I	KF-10063AI	KF-11063I	KF-19063CTAI	KF-11063SI	KF-10063ASI	KF-16050I
80	KF-15050PI	KF-17050I	KF-12080I	KF-13080I	KF-10080AI	KF-11080I	KF-19080CTAI	KF-11080SI	KF-10080ASI	KF-16080I
100	KF-15050PI	KF-17050I	KF-12100I	KF-13100I	KF-10100AI	KF-11100I	KF-19100CTAI	KF-11100SI	KF-10100ASI	KF-16080I

Ø	DF bracket and adapter	DF sensor
20	DH-P020DFI	DF-P700L06
25	DH-P025032DFI	
32	DH-P025032DFI	
40	DH-P040DFI	
50	DH-P050DFI	
63	DH-P063DFI	
80	DH-P080DFI	
100	DH-P100DFI	

COMPACT

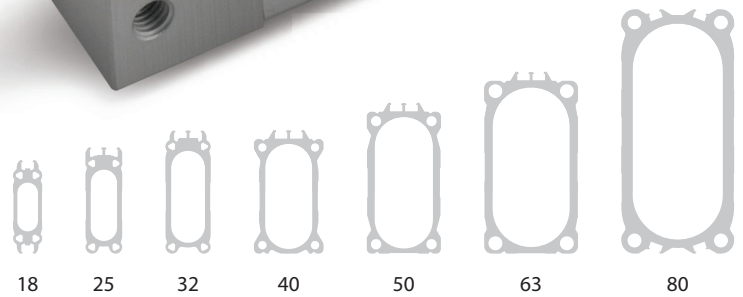
Up to **40%** width reduction if compared to standard cylinders

ANTI-ROTATION

Piston rod max rotation $0,3^\circ \div 0,9^\circ$

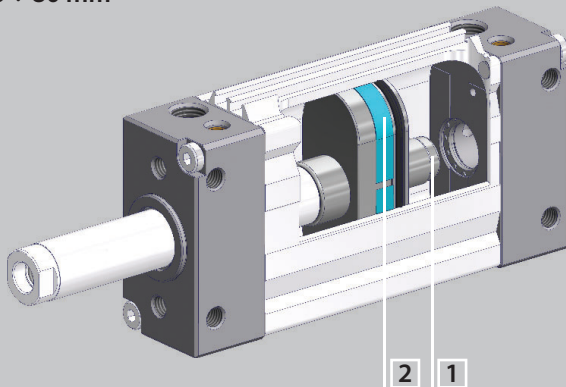
CUSHIONING

Standard supplied $\varnothing 18 \div 80$ mm (adjustable pneumatic cushionings)



OV

$\varnothing 18 \div 80$ mm



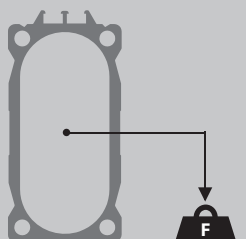
1 Adjustable pneumatic cushioning

- Standard supplied
- No variation in dimensions comparing to an equivalent cylinder without cushionings

2 Oversized piston guide and UNIVER original seal

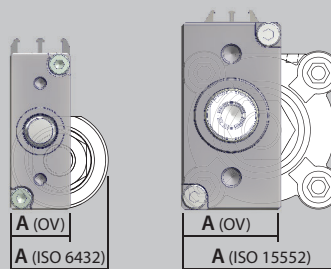
- Suitable for heavy loads (F)
- Piston rod rotation highly reduced

Max applicable torque (Nm) and related Max rotation



\varnothing	F (Nm)	Degrees
18	0,80	0,90
25	1,00	0,80
32	1,40	0,60
40	1,70	0,40
50	2,00	0,35
63	2,30	0,30
80	2,60	0,30

Comparison of A dimension: OV cylinder vs ISO standard cylinder

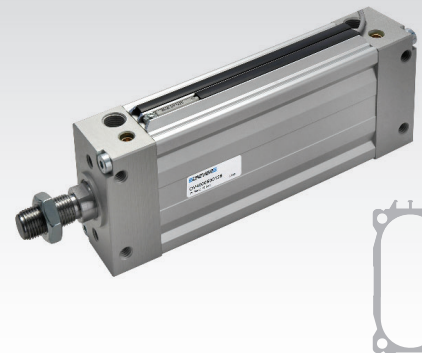


\varnothing	A (OV)	A (ISO)	Reduction
18	16	28	-42%
25	20	31	-35%
32	24,5	48	-45%
40	38	54	-30%
50	40	67	-40%
63	50	78	-35%
80	60	97	-38%

1

CHARACTERISTICS

Ambient temperature	-20 ÷ 80 °C
Fluid	filtered air, with or without lubrication
Working pressure	1,5 ÷ 10 bar
End-caps	anodized aluminium
Barrel	anodized aluminium
Piston	aluminium
Guide slide	technopolymer
Piston rod	stainless steel (Ø18-25), chromium-plated steel (Ø18÷80)
Piston seal	NBR
Guide bush for piston rod	standard supplied
Piston rod scraper seals	polyurethane
Cushionings	adjustable on both sides (standard supplied)
Magnet	Neodymium (standard supplied)

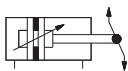


CODIFICATION KEY

O	V	2	0	0	0	3	2	0	0	5	0	
1	2	3	4		5			6				

1 Series	2 Type	3 Version
-----------------	---------------	------------------

OV = Ø 18÷80 mm - Oval Cylinders



- 1 =** Stainless steel female piston rod (Ø18÷80)
2 = Chromium-plated steel female piston rod (Ø32÷80)
3 = Stainless steel male piston rod (Ø18÷80)
4 = Chromium-plated steel male piston rod (Ø32÷80)

- 00 = D.A.** Standard version
01 = D.A. Through piston rod
02 = D.A. Hollow through piston rod

D.A. = Double acting

4 Bore (mm)	5 Stroke (mm)	6 ATEX Option
--------------------	----------------------	----------------------

- 018** = Ø18
025 = Ø25
032 = Ø32
040 = Ø40
050 = Ø50
063 = Ø63
080 = Ø80

- 0010 - 0025 - 0040 - 0050 - 0080 - 0100 - 0125 - 0160 - 0200** (Ø18-25)
0010 - 0025 - 0040 - 0050 - 0080 - 0100 - 0125 - 0160 - 0200 - 0250 - 0320 (Ø32÷80)

- X =** ATEX (upon request)
 See ATEX Catalogue for types and versions

Theoretical forces (**N**) developed at working pressure (**bar**)

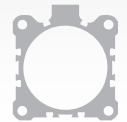
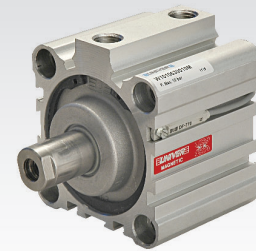
Ø	Working pressure					Working pressure					Cushioning length
	bar					bar					
	2	4	6	8	10	2	4	6	8	10	
18	54	108	162	216	270	41	82	122	163	204	8
25	98	196	295	393	491	82	165	247	330	412	10
32	161	322	483	643	804	138	276	415	553	691	10
40	251	502	754	1005	1256	221	422	633	844	1055	14
50	393	785	1178	1570	1963	330	660	990	1320	1650	Front 11/Back 14
63	623	1246	1870	2493	3116	560	1120	1682	2240	2800	Front 11/Back 14
80	1005	2010	3015	4019	5024	942	1884	2826	3770	4711	Front 20/Back 27

FIXING ELEMENTS AND ACCESSORIES

Ø	Female fork with clips	Articulated self-lubricating fork	Fork with axially mounted articulated pin	Fork with angle mounted articulated pin	Floating joint	Angle bracket	Male hinge	Flange	DF sensor and DHF covering strip	Cable clamping for DF sensor
18										
25	MF-15020	MF-17020	MF-22020	MF-23020	KF-24020	OVF-13018	OVF-11018	OVF-12018		
32	KF-15032	KF-17032	KF-22025	KF-23025	KF-24032	OVF-13025	OVF-11025	OVF-12025		
40	KF-15040	KF-17040	KF-22040	KF-23040	KF-24040	OVF-13040	OVF-11040	OVF-12040		
50	KF-15050	KF-17050	KF-22050	KF-23050	KF-24050	OVF-13050	OVF-11050	OVF-12050		
63	KF-15050	KF-17050	KF-22050	KF-23050	KF-24050	OVF-13063	OVF-11063	OVF-12063		
80	KF-15050	KF-17050	KF-22050	KF-23050	KF-24050	OVF-13080	OVF-11080	OVF-12080	DF DHF-0020100	DF-001

CHARACTERISTICS

Ambient temperature	-20 ÷ 80 °C
Fluid	filtered air, with or without lubrication
Working pressure	1,5 ÷ 10 bar
End-caps	aluminium
Barrel	aluminium
Piston	aluminium
Guide slide	technopolymer
Piston rod	stainless steel
Piston seal	NBR
Guide bush for piston rod	standard supplied
Piston rod scraper seal	polyurethane
Shock absorber seals	NBR (standard supplied)
Other versions available	tandem, two-position tandem, multiple position tandem



CODIFICATION KEY

W	1	0	0	0	3	2	0	0	5	0			
1	2	3	4	5	6	7	8						

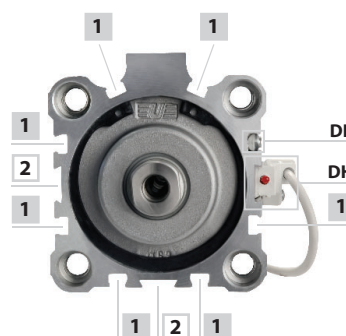
1 Series	2 Type	3 Version	4 Bore (mm)
W = Ø 12÷100 mm Short Stroke Cylinders	1 = Stainless steel piston rod 7 = Stainless steel female piston rod with male rear hinge, versions 00 - 10 - 60 - 70 (except for bore Ø12)	00 = D.A. Standard version 01 = D.A. Through piston rod 10 = D.A. Non-rotating piston rod (except for Ø 12) 11 = D.A. Non-rotating through piston rod (except for Ø 12) 31 = D.A. Hollow through piston rod (except for Ø 12-16) 60 = S.A. Retracted piston rod 70 = S.A. Extended piston rod	012 = Ø12 016 = Ø16 020 = Ø20 025 = Ø25 032 = Ø32 040 = Ø40 050 = Ø50 063 = Ø63 080 = Ø80 100 = Ø100
		D.A. = Double acting S.A. = Single acting	

5 Stroke (mm)	6 Option	7 Magnetic	8 ATEX option
Single acting 0005 - 0010 (Ø12÷25) 0005 - 0010 - 0025 (Ø32÷100) Double acting 0005 - 0010 - 0020 - 0025 - 0030 - 0040 - 0050 (Ø12-16) 0005 - 0010 - 0020 - 0025 - 0030 - 0040 - 0050 - 0075 (Ø20÷100)	S = Safety distance (only for versions 10 and 11)	M = Magnetic version (except for Ø 12)	X = Atex (upon request) See ATEX Catalogue for types and versions

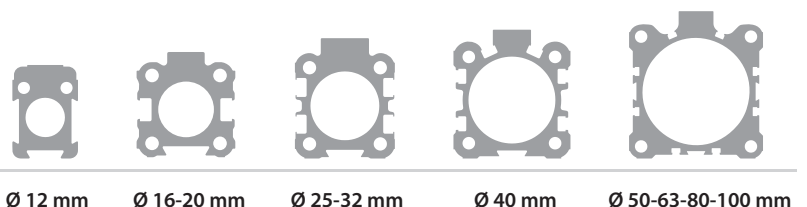
FIXING ELEMENTS AND ACCESSORIES

Ø	Nipple	DF sensor and DHF covering strip	Cable clamping for DF sensor	DH sensor
12				
16	WF-50012			
20	WF-50020			
25	WF-50020			
32	WF-50032			
40	WF-50040			
50	WF-50050			
63	WF-50063			
80	WF-50080			
100	WF-50080			

TUBE PROFILE



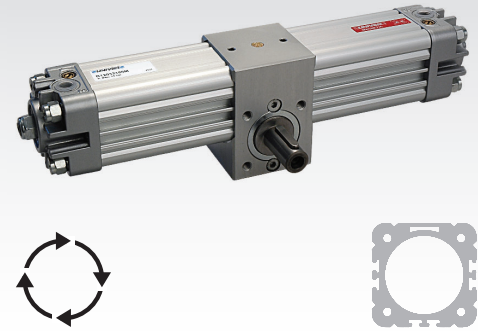
- 1 Groove for DF series recessed sensor
- 2 Groove for DH series traditional sensor



1

CHARACTERISTICS

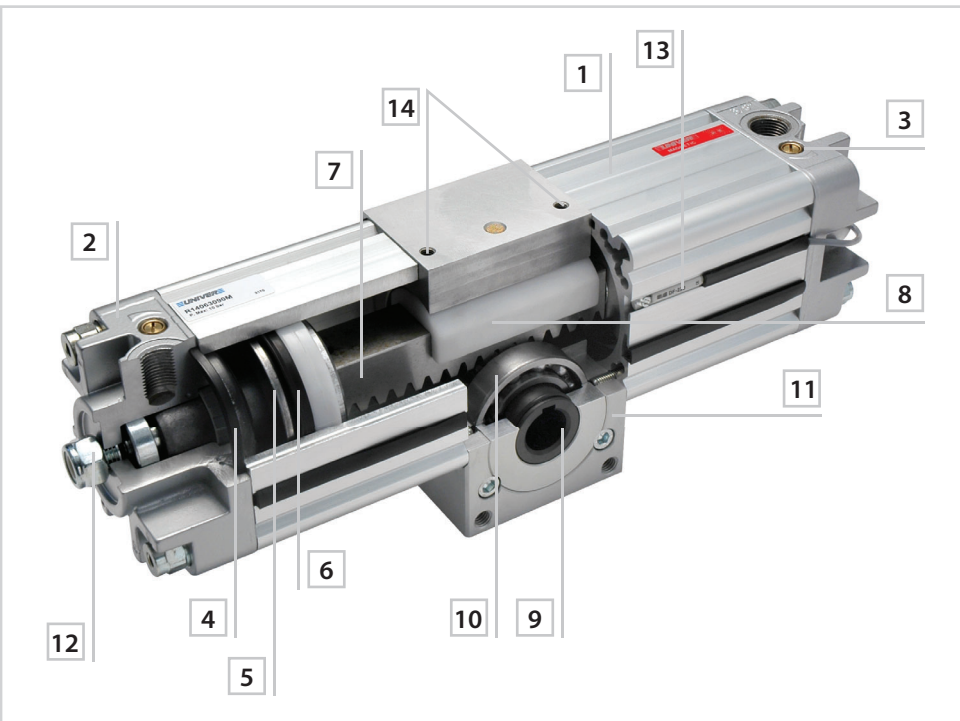
Ambient temperature	-20 ÷ 80 °C
Fluid	filtered air, with or without lubrication
Working pressure	1,5 ÷ 10 bar
End-caps	aluminium
Barrel	aluminium
Piston	die-cast aluminium
Guide slide	acetalic resin
Rack	stainless steel
Piston seal	NBR
Pinion	nitrided steel
Shock absorber seals	NBR
Cushionings	adjustable on both sides (standard supplied)



CODIFICATION KEY

R	1	1	0	3	2	1	8	0	
1	2	3	4	5					

1 Series	2 Type	3 Bore (mm)	4 Angle of rotation	5 Magnetic
R = Ø 32÷125 mm Pneumatic rotary Cylinders	11 = Male pinion without adjustment (degree of accuracy ± 3°) 12 = Male pinion with adjustment ± 5° 13 = Female pinion without adjustment (degree of accuracy ± 3°) 14 = Female pinion with adjustment ± 5°	032 = Ø32 040 = Ø40 050 = Ø50 063 = Ø63 080 = Ø80 100 = Ø100 125 = Ø125	090 = 90° 180 = 180° 270 = 270° 360 = 360°	M = Magnetic version



- | | |
|--|---|
| <ul style="list-style-type: none"> 1. Cylinder barrel: extruded profile in aluminium 2. Die-cast end-caps in aluminium 3. Adjustable on both sides cushionings 4. Shock absorber seals 5. Die-cast piston in aluminium alloy and acetalic resin guide slide 6. Piston seals in nitrile rubber compound 7. Standards-based steel square rack | <ul style="list-style-type: none"> 8. Guide slide for rack with self-adjusting backlash recovery 9. Nitrided steel pinion 10. Ball bearings for pinion support 11. Anodized aluminium central body 12. Adjustment screws: angle of rotation ±2,5° 13. DF series magnetic sensor 14. Screws for backlash recovery |
|--|---|

ACCESSORIES

Ø	DF sensor and DHF covering strip	Cable clamping for DF sensor
32	 DF DHF-0020100	 DF-001
40		
50		
63		
80		
100		
125		

CHARACTERISTICS

Ambient temperature	-20° ÷ 80 °C
Fluid	filtered air, with or without lubrication, neutral gases
Working pressure	4 ÷ 8 bar (single acting) 2 ÷ 8 bar (double acting)
Connections	NAMUR interface (G1/4)
Rotation	0-90°±3° (external adjustment)
Max pressure	10 bar
End-caps	die-cast aluminium
Piston	die-cast aluminium
Guide slide	acetalic resin
Seals	NBR
Body	hard anodized aluminium extrusion
Pinion	nickel-plated steel
Screws and nuts	stainless steel

Connections: bottom hole for ball valve installation in compliance with ISO 5211/DIN 3337 standards.
Solenoid valve interface, shaft top-end and top hole for accessory fixing in compliance with VDI/VDE 3845 NAMUR standards.



CODIFICATION KEY

Y	R	2	0	1	D	A	0	
1		2		3				

1 Series	2 Size (mm)	3 Version
YR2 = Rotary Actuators for Process Automation	00 = 32 (DA0 only) 01 = 50 2A = 63 (F04) 2B = 63 (F05) 03 = 75 35 = 85 04 = 100	45 = 115 05 = 125 55 = 145 06 = 160 08 = 200 10 = 250 DA0 = Double acting S12 = Single acting - 12 springs standard (different number of springs upon request)

Torque - double acting version (P = 6 bar)

Part No.	Torque (Nm)
YR200DA0	7,3
YR201DA0	17,7
YR22ADA0-YR22BDA0	28,2
YR203DA0	60
YR235DA0	102
YR204DA0	142
YR245DA0	261,6
YR205DA0	333
YR255DA0	473
YR206DA0	680
YR208DA0	1276
YR210DA0	3234

Torque - single acting version (P = 6 bar)

Part No.	Torque (Nm)	
	0°	90°
YR201S12	10,5	7,2
YR22AS12-YR22BS12	16,8	11,4
YR203S12	36	24
YR235S12	64	39
YR204S12	87	56
YR245S12	159,6	101,6
YR205S12	203	130
YR255S12	303	173
YR206S12	429	260
YR208S12	796	520
YR210S12	1909	1254

<p>■ YR series ball valve</p> 	<p>■ AC-N series NAMUR valves</p> 	<p>■ AC-N series valves with actuator</p> 
---	---	---

YR3



Part. No	Ø	Torque (Nm)*	Kinetic energy (J)	Sensor
YR3003	10	0,3	0,002	DF-T
YR3007	12	0,6	0,006	
YR3010	15	1,5	0,006	
YR3020	18	2,2	0,025	
YR3030	20	3,2	0,048	
YR3050	25	5,5	0,080	
YR3070	28	7,5	0,24	
YR3100	32	9,8	0,32	
YR3200	40	19	0,56	

* = Theoretical torque at 5 bar

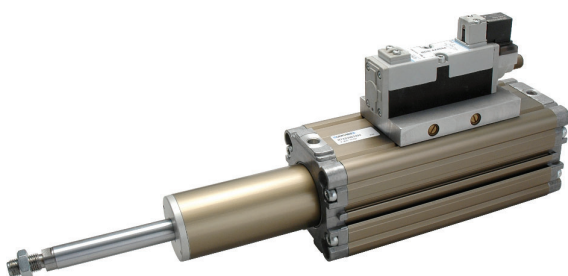
- Ambient temperature: 0 ÷ 50 °C
- Working pressure: 1,5 ÷ 7 bar
- Rotation angle: 0° ÷ 180°
- Version upon request: with idraulic shock absorbers Ø 15 ÷ 63
(add suffix D to part no. e.g. YR3010D)

Examples of CYLINDER - VALVE assembly

- **RV - STRONG cylinder with integrated VDMA valve**
STRONG cylinder with integrated 5/2-5/3 VDMA solenoid valve, side 18 or 26 mm.
Supply and exhaust occur directly from the connection plate between valve and cylinder and exhausts are adjustable.
Electrical connection M12 can be operated also from a PLC.



- **RW - Telescopic cylinder with integrated VDMA valve**
Telescopic cylinder with integrated 5/2-5/3 VDMA solenoid valve, side 18 or 26 mm.
Supply and exhaust occur directly from the connection plate between valve and cylinder and exhausts are adjustable.
Electrical connection M12 can be operated also from a PLC.



- **KD series ISO 15552 cylinder with integrated valve**
Valve mounting by means of a proper plate embedded in one of tube sensor grooves.



- **RS series STRONG cylinder with integrated valve**
Valve mounting by means of a proper plate embedded in one of tube sensor grooves.

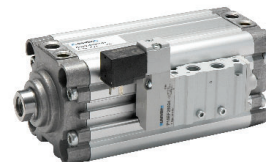
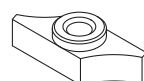
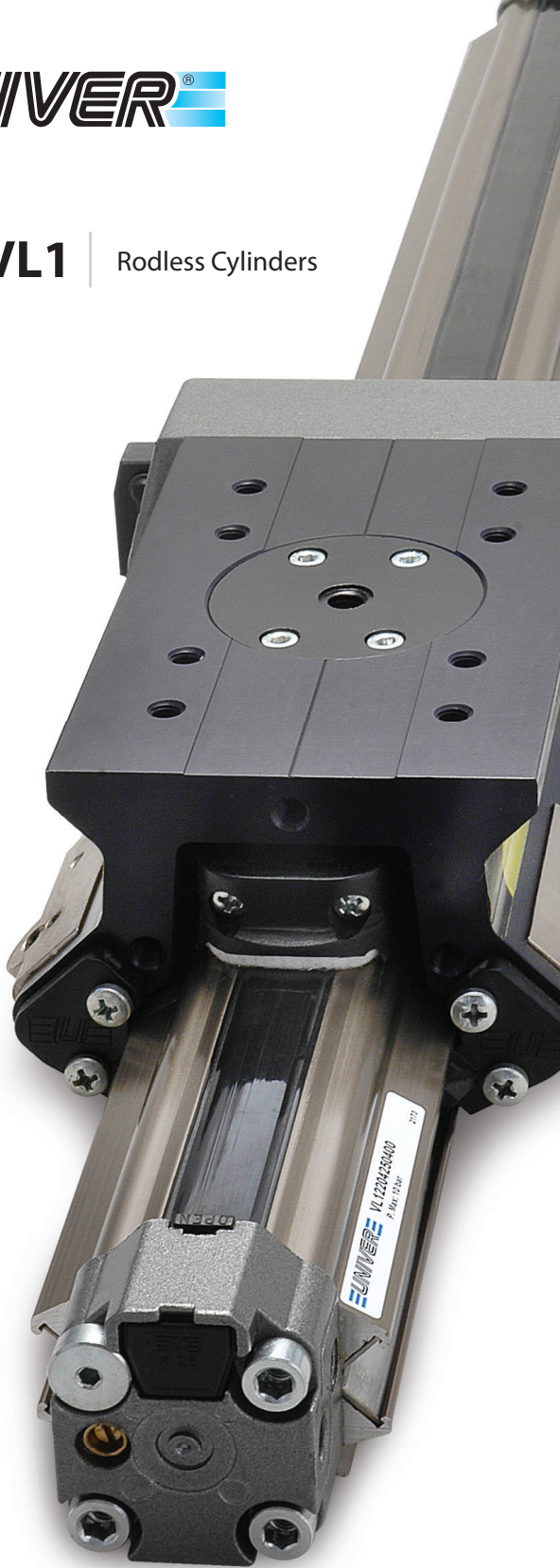


Plate for mounting valve on sensor groove

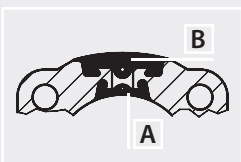


DF-003 (M3)
DF-004 (M4)

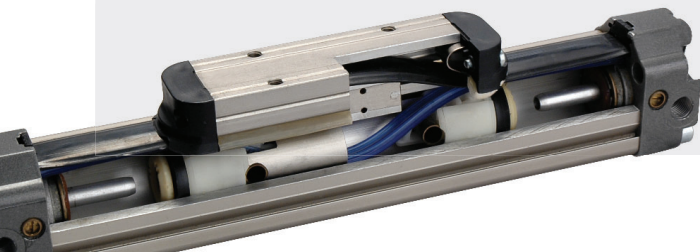
S1-S5-VL1 | Rodless Cylinders



UNIVER Original since 1988

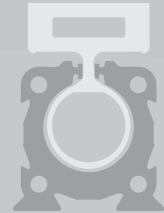


A - Internal strip (seal)
B - External strip (protection) made of reinforced elastomer with Kevlar fiber



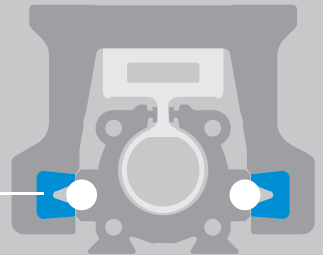
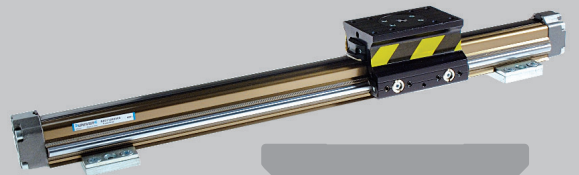
S1

Ø 16 ÷ 50 mm - Standard version



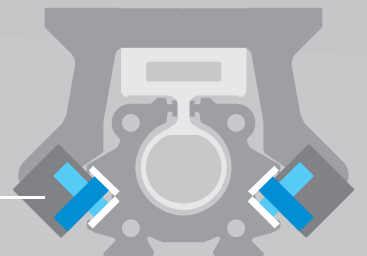
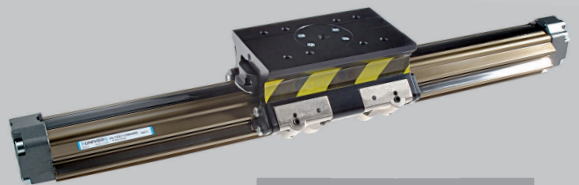
S5

Ø 25 ÷ 50 mm - Version with integrated guides
 Technopolymer sliding guide

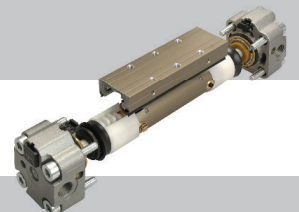


VL1

Ø 25 ÷ 50 mm - Version with 90° integrated guides
 Sliding on ball bearings



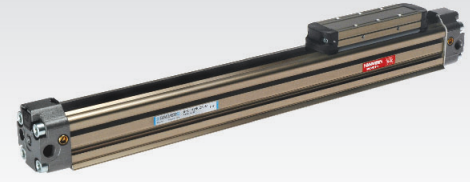
Assembly Kit
 available for all series



1

CHARACTERISTICS

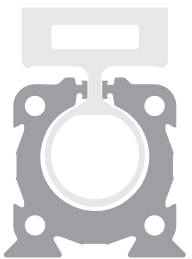
Ambient temperature	-20 ÷ 80 °C
Fluid	filtered air, with or without lubrication
Working pressure	3 ÷ 10 bar
End-caps	die-cast light alloy
Barrel	anodized aluminium
Piston	aluminium
Guide slide	acetalic resin
Piston seal	NBR
Shock absorber seals	mechanical
Cushionings	adjustable on both sides (standard supplied)
Magnet	upon request



CODIFICATION KEY

S	1	0	1	1	2	5	0	8	5	0		
1	2	3	4	5	6	7	8					

1 Series S1 = Ø 16÷50 mm - Rodless Cylinders standard version	2 Carriage type 0 = Standard carriage 2 = Medium carriage (except for Ø16) 3 = Long carriage (except for Ø16)	3 Left end-cap supply port 0 = No supply port (both chambers are supplied from the right end-cap) 1 = Side supply port (except for Ø16) 2 = Bottom supply port (except for Ø16) 3 = Rear supply port (except for Ø16)
4 Right end-cap supply port 1 = Side supply port (except for Ø16) 2 = Bottom supply port (except for Ø16) 3 = Rear supply port (except for Ø16) 4 = Rear supply ports for both chambers on the right end-cap 5 = Side supply ports for both chambers on the right end-cap (only for Ø16)	5 Bore (mm) 16 = Ø16 25 = Ø25 32 = Ø32 40 = Ø40 50 = Ø50	6 Stroke (mm) Up to 5000 (Ø 16) Up to 6000 (Ø 25÷50)
7 Magnetic M = Magnetic version standard supplied (Ø 16) upon request (Ø 25÷50)	8 ATEX option X = Atex (upon request) See ATEX Catalogue for types and versions	



S1

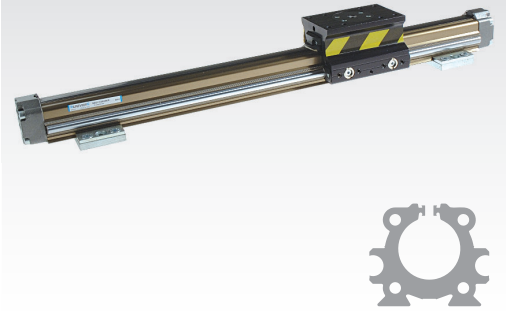
- Extruded aluminium profile Ø 16 ÷ 50 mm
- Stroke up to 6 m
- Different supply port configurations available
- Different carriage types
- High translation speed 0,2 ÷ 3 m/s

FIXING ELEMENTS AND ACCESSORIES

Ø	Bracket	Angle bracket	Fixing plate	Oscillating bracket	Female threaded connection	Male threaded pin	Female connection without thread	DF sensor and DHF covering strip	Cable clamping for DF sensor	DH sensor	Bracket for DH sensor
16		-	SF-12016	SF-24016	SF-26016	SF-27016	SF-28016	DF	DF-001	-	-
25	-	SF-13025	SF-12025	SF-24025	SF-26025	SF-27025	SF-28025	-	-	DH	DH-S25
32	-	SF-13032	SF-12032	SF-24032	SF-26032	SF-27032	SF-28032	-	-		DH-S32
40	SF-13040	-	SF-12040	SF-24032	SF-26032	SF-27032	SF-28032	-	-		DH-S40
50	SF-13050	-	SF-12050	-	-	-	-	-	-	-	DH-S50

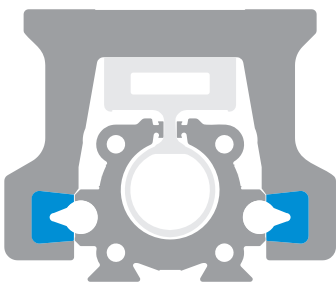
CHARACTERISTICS

Ambient temperature	-20 ÷ 80 °C
Fluid	filtered air, with or without lubrication
Working pressure	3 ÷ 10 bar
End-caps	die-cast light alloy
Barrel	anodized aluminium
Piston	aluminium
Guide slide	acetalic resin
Piston seal	NBR
Shock absorber seals	mechanical
Cushionings	adjustable on both sides (standard supplied)


CODIFICATION KEY

S	5	0	1	1	2	5	0	8	5	0	
1	2	3	4	5	6						

1 Series S5 = Ø 25÷50 mm - Rodless Cylinders with integrated guides - Technopolymer sliding guide	2 Carriage type 0 = Standard carriage (except Ø 40-50) 2 = Medium carriage 3 = Long carriage	3 Left end-cap supply port 0 = No supply port (both chambers are supplied from the right end-cap) 1 = Side supply port 2 = Bottom supply port 3 = Rear supply port
4 Right end-cap supply port 1 = Side supply port 2 = Bottom supply port 3 = Rear supply port 4 = Rear supply ports for both chambers on the right end-cap	5 Bore (mm) 25 = Ø25 32 = Ø32 40 = Ø40 50 = Ø50	6 Stroke (mm) Up to 6000


S5

- Extruded aluminium profile Ø 25 ÷ 50 mm
- Stroke up to 6 m
- Flexible guide system
- Sliding of the carriage with plastic slide on steel shafts
- Translation speed 0,2 ÷ 1,5 m/sec.
- Version with locking unit available

FIXING ELEMENTS

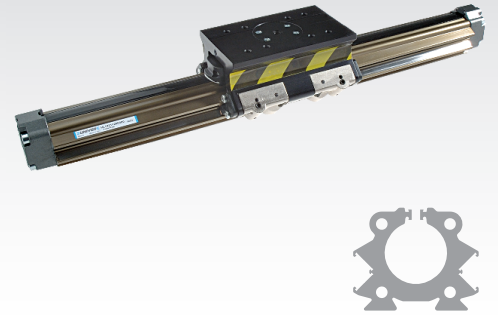
Ø	Bracket	Angle bracket	Fixing plate
25	-	SF-13025	SF-12025
32	-	SF-13032	SF-12032
40	SF-13040	-	SF-12040
50	SF-13050	-	SF-12050

■ S5 with L6 locking unit



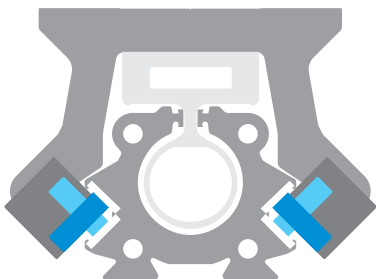
1
CHARACTERISTICS

Ambient temperature	-20 ÷ 80 °C
Fluid	filtered air, with or without lubrication
Working pressure	3 ÷ 10 bar
End-caps	die-cast light alloy
Barrel	anodized aluminium
Piston	aluminium
Guide slide	acetalic resin
Piston seals	NBR
Shock absorber seals	mechanical
Cushionings	adjustable on both sides (standard supplied)


CODIFICATION KEY

V	L	1	2	2	1	1	3	2	0	8	5	0
		1	2	3	4	5	6		7			

1 Series	2 Carriage type	3 No. of ball bearing pairs standard supplied		4 Left end-cap supply port	5 Right end-cap supply port	6 Bore (mm)	7 Stroke (mm)
VL1 = Ø 25÷50 mm - Rodless Cylinders with 90° integrated guides Sliding on ball bearings	2 = Medium carriage 3 = Long carriage	Medium carriage 2 = Ø 25÷40 3 = Ø 50	Long carriage 3 = Ø 25÷40 4 = Ø 50	0 = No supply port (both chambers are supplied from the right end-cap) 1 = Side supply port 2 = Bottom supply port 3 = Rear supply port	1 = Side supply port 2 = Bottom supply port 3 = Rear supply port 4 = Rear supply ports for both chambers on the right end-cap	25 = Ø25 32 = Ø32 40 = Ø40 50 = Ø50	Up to 6000


VL1

- Extruded aluminium profile Ø 25 ÷ 50 mm
- Stroke up to 6 m
- Heavy duty precision series
- Rigid guide system
- Sliding of the carriage on ball bearings
- Translation speed 0,2 ÷ 2 m/sec.
- Version with locking unit available

FIXING ELEMENTS

Ø	Bracket	Angle bracket	Fixing plate
25		SF-13025	SF-12025
32	-	SF-13032	SF-12032
40	SF-13040	-	SF-12040
50	SF-13050	-	SF-12050

VL1 with L6 locking unit


J Slide Units

STRONG

Extruded aluminium profile structure
UNIVER Original

STURDY

Oversized hollow guiding shafts
made of chromium-plated steel

SMOOTH SLIDING

Self-lubricating guiding bushes
made of special steel

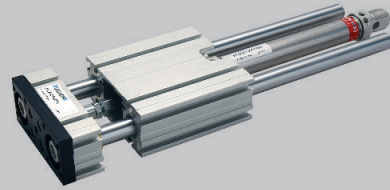
STANDARD

Wide range of standard solutions
for any application requirement

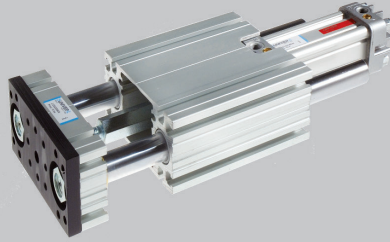


J1

ISO 6432 Cylinders

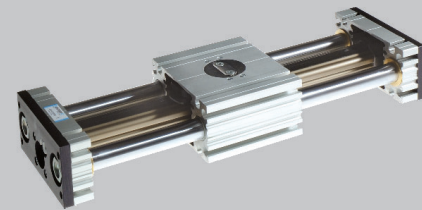


ISO 1552 Cylinders



J3

Rodless Cylinders



J_RS

STRONG Cylinders

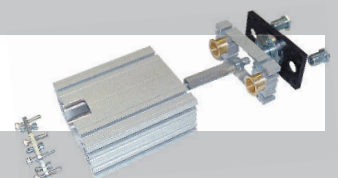


J64RT2

Telescopic Cylinders



KIT Assembly Kit
available for all series



1

CHARACTERISTICS

Ambient temperature	-20 ÷ 80 °C
Fluid	filtered air, with or without lubrication
Working pressure	2 ÷ 10 bar
Barrel	extruded anodized aluminium
Guide bush for piston rod	special steel
Shafts	chromium-plated steel
Shaft scraper seals	polyurethane
Flange	steel



Slide Units for M, KE/K, KD series cylinders

J1



CODIFICATION KEY

J	1	0	A	5	5	0	0	5	0	A
1	2	3	4	5	6		7			

1 Series	2 Type	3 Accessories
-----------------	---------------	----------------------

- | | | |
|-----------------------|--|---|
| <p>J = Slide Unit</p> | <p>10 = Protruding shafts and short housing (recommended for strokes up to 50 mm)
 11 = Protruding shafts and medium housing
 12 = Protruding shafts and long housing
 14 = Fully protected cylinder</p> | <p>16 = Central mounting (semi-external cylinder)
 17 = Central mounting (fully protected cylinder)
 18 = Medium moving housing (external cylinder)
 19 = Long moving housing (external cylinder)</p> <p>A = Shaft scrapers standard supplied</p> |
|-----------------------|--|---|

4 Slide unit size	5 Cylinder bore (mm)	6 Cylinder stroke (mm)	7 Cylinder option
--------------------------	-----------------------------	-------------------------------	--------------------------

- | | | | |
|---|--|---|---|
| <p>0 = 16 for Ø16 cylinders
 2 = 25 for Ø25 cylinders
 3 = 32 for Ø32 cylinders
 4 = 40 for Ø40 cylinders
 5 = 50 for Ø50 cylinders
 6 = 63 for Ø63 cylinders
 7 = 80 for Ø80 cylinders
 8 = 100 for Ø100 cylinders</p> | <p>0 = Ø16
 2 = Ø25
 3 = Ø32
 4 = Ø40
 5 = Ø50
 6 = Ø63
 7 = Ø80
 8 = Ø100</p> | <p>M
 0025 - 0030 - 0040 - 0050 - 0075
 0100 - 0125 - 0150 - 0160 - 0175
 0200 - 0250 - 0300 - 0400 - 0500</p> <p>KE/K - KD
 0025 - 0050 - 0075 - 0080 - 0100
 0125 - 0150 - 0160 - 0175 - 0200
 0250 - 0300 - 0320 - 0400 - 0450
 0500 - 0600 - 0700 - 0800 - 0900
 1000</p> | <p>A = M150 series Ø16÷25 microcylinders
 K200 series Ø32÷100 cylinders
 B = M250 series Ø16÷25 microcylinders with locking unit
 K200 series Ø32÷100 cylinders with locking unit (only for J12, J14, J16, J17)
 C = KE200 series Ø 32÷100 cylinders
 D = KE200 series Ø 32÷100 cylinders with locking unit (only for J12, J14, J16, J17)
 E = KD200 series Ø32÷100 cylinders
 F = KD200 series Ø32÷100 cylinders with locking unit (only for J12, J14 and J16)</p> |
|---|--|---|---|

FIXING ELEMENTS

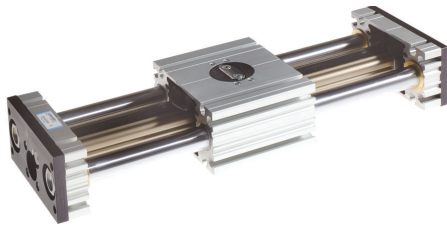
Ø	Aluminium fixing bracket	Aluminium fixing bracket	Steel fixing plate	Aluminium fixing bracket	Rod support for Serie J guide unit
16					
25	JF-13016	JF-14016	JF-42016	JF-43016	JF-601016
32	JF-13025	JF-14025	JF-42025	JF-43025	JF-601025
40	JF-13032	JF-14032	JF-42040	JF-43040	JF-601032
50	JF-13040	JF-14040	JF-42040	JF-43040	JF-601040
63	JF-13050	JF-14050	JF-42050	JF-43050	JF-601050
80	JF-13063	JF-14063	JF-42063	JF-43063	JF-601063
100	JF-13080	JF-14100	JF-42100	JF-43100	JF-601080
	JF-13100	JF-14100	JF-42100	JF-43100	JF-601100

Slide units are supplied with integrated cylinder

Subject to change

Slide Units for S1 series rodless cylinders

J3



CODIFICATION KEY

J	3	0	A	5	3	0	1	0	0	A
1	2	3	4	5	6		7			

1 Series J = Slide Unit	2 Type 30 = Fully protected cylinder (2 bearings - standard carriage) 31 = Fully protected cylinder (2 bearings - long carriage)	3 Accessories A = Shaft scrapers standard supplied
-----------------------------------	---	--

4 Slide unit size 4 = 40 for Ø25 cylinders 5 = 50 for Ø32 cylinders 6 = 63 for Ø40 cylinders 7 = 80 for Ø50 cylinders	5 Cylinder bore (mm) 2 = Ø25 3 = Ø32 4 = Ø40 5 = Ø50	6 Slide unit stroke (mm) Up to 0800	7 Supply port option A = Supply ports on both end-caps B = Supply ports on the right end-cap only
--	---	---	--

Slide Units for RS series STRONG compact cylinders

J_RS



CODIFICATION KEY

J	6	4	R	S	3	3	0	0	5	0	B
1	2	3	4	5	6		7				

1 Series J = Slide Unit - Shaft scrapers standard supplied	2 Slide unit type 64 = Fully protected cylinder (stroke longer than 50 mm) 65 = Fully protected cylinder, through opening 66 = Fully protected cylinder, through opening, two plates 67 = Fully protected cylinder, two plates (stroke longer than 50 mm)	3 Cylinder type RS = STRONG cylinder (RS22J... series) with long piston and tube with sensor grooves on the same side as supply ports to allow mounting of magnetic sensors
--	--	---

4 Slide unit size 3 = 32 for Ø32 cylinders 4 = 40 for Ø40 cylinders 5 = 50 for Ø50 cylinders 6 = 63 for Ø63 cylinders	5 Cylinder bore (mm) 3 = Ø32 4 = Ø40 5 = Ø50 6 = Ø63	6 Slide unit stroke (mm) 0015 ÷ 0800	7 Cylinder option A = Cylinder with long piston B = Cylinder with long piston and locking unit
--	---	--	---

Slide units are supplied with integrated cylinder

1

Slide Units for RT2 series telescopic cylinders

J64RT2



CODIFICATION KEY

J	6	4	R	T	2	4	4	0	8	0	0	A
1	2	3			4	5	6				7	

1 Series J = Slide Unit - Shaft scrapers standard supplied	2 Slide unit type 64 = Fully protected telescopic cylinder	3 Cylinder type RT2 = 2 stage telescopic cylinders
--	--	--

4 Slide unit size 3 = 32 for Ø32 cylinders 4 = 40 for Ø40 cylinders 5 = 50 for Ø50 cylinders 6 = 63 for Ø63 cylinders	5 Cylinder bore (mm) 3 = Ø32 4 = Ø40 5 = Ø50 6 = Ø63	6 Slide unit stroke (mm) Standard stroke 0120 - 0160 - 0180 - 0200 - 0300 - 0400 - 0500 0600 - 0700 - 0800 - 0900 - 1000 - 1100 - 1200 Min - Max stroke 0160 ÷ 0400 (Ø32) 0160 ÷ 0600 (Ø40) 0120 ÷ 0900 (Ø50) 0120 ÷ 1200 (Ø63)	7 Cylinder option A = 2 stage telescopic cylinders
--	---	--	--

Slide Units for RP series compact cylinders

J65



CODIFICATION KEY

J	6	5	R	P	2	2	0	0	5	0	A
1	2	3	4	5	6		7				

1 Series J = Slide Unit - Shaft scrapers standard supplied	2 Slide unit type 65 = Fully protected cylinder, through opening	3 Cylinder type RP = UNITOP Ø25 mm compact cylinder
--	--	---

4 Slide unit size 2 = 25 for Ø25 cylinders	5 Cylinder bore (mm) 2 = Ø25	6 Slide unit stroke (mm) 0050 ÷ 0200	7 Cylinder option A = Cylinder with long piston
--	--	--	---

Slide units are supplied with integrated cylinder

CHARACTERISTICS

Ambient temperature	-5 ÷ +60 °C
Fluid	filtered air, with or without lubrication
Working pressure	1 ÷ 10 bar
Body	aluminium
Shafts	chromium-plated steel (JLES), hardened-plated steel (JLEV)
Piston	aluminium
Piston rod	C40 chromium-plated steel
Guide bearing	bearings (JLES), ball bushing (JLEV)
Piston seal	polyurethane
Shock absorber seals	polyurethane
Magnet	standard supplied
Flange	steel


CODIFICATION KEY

J	L	E	S	0	1	2	0	0	3	0	
1			2		3			4		5	

1 Series

JLE = $\varnothing 12 \div 63$ mm - Guided Compact Cylinders

2 Guide bearing

S = Bearings
V = Ball bushing

3 Bore (mm)

012 = $\varnothing 12$ 032 = $\varnothing 32$
016 = $\varnothing 16$ 040 = $\varnothing 40$
020 = $\varnothing 20$ 050 = $\varnothing 50$
025 = $\varnothing 25$ 063 = $\varnothing 63$

4 Stroke (mm)

0010 = 10 0075 = 75
0020 = 20 0100 = 100
0025 = 25 0125 = 125
0030 = 30 0150 = 150
0040 = 40 0175 = 175
0050 = 50 0200 = 200

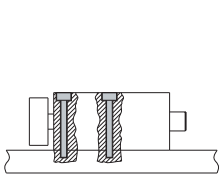
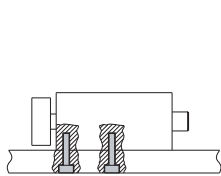
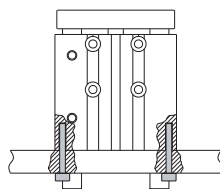
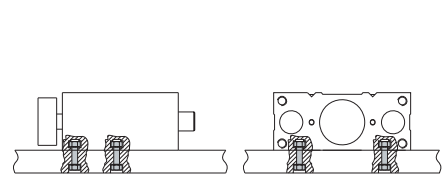
\varnothing	Standard stroke (mm)*											
	10	20	25	30	40	50	75	100	125	150	175	200
12												
16												
20												
25												
32												
40												
50												
63												

* Extra strokes upon request

5 ATEX option

X = ATEX (upon request)

See ATEX Catalogue for types and versions

Fixing schemes
Top fixing

Bottom fixing

Rear fixing

T-slot fixing

DF-T magnetic sensor
ELECTROMECHANICAL

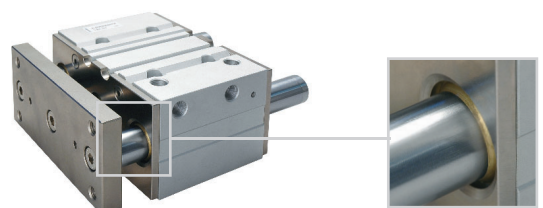
DF-T200L03
DF-T200M08

ELECTRONIC (PNP)

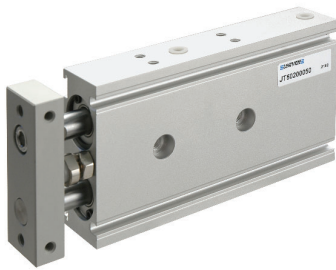
DF-T700L03
DF-T700M08

SLOT ADAPTER

DF-R002 ($\varnothing 12$ mm)
DF-R003 ($\varnothing 16 \div 63$ mm)


Upon request
Version with metallic piston rod scraper


Special versions upon request: metal rods scrapers, pneumatic cushioning, high temperature (+120°)

1
Ø 6 ÷ 32 mm - Twin Rod Guided Cylinder
JTE

 Ambient temperature: -5 ÷ 60 °C
 Stroke adjustment: 0 ÷ 5 mm

Part No.	Ø	Working pressure (bar)	Theoretical thrust force (N)*		Standard stroke (mm)	Max stroke (mm)	Sensor
			Thrust	Traction			
JTES006 JTEV006	6	1,5 ÷ 7	28	15,5	10-20-30	50	DF-T + DF-R002 (adapter)
JTES010 JTEV010	10	1 ÷ 7	113	84	10-15-20-25-30 35-40-45-50-60-70	70	
JTES015 JTEV015	15	1 ÷ 7	200	150	10-15-20-25 30-35-40-45 50-60-70-75 80-90-100	120	
JTES020 JTEV020	20	0,5 ÷ 7	314	236		130	
JTES025 JTEV025	25	0,5 ÷ 7	490	378		150	
JTES032 JTEV032	32	0,5 ÷ 7	802	603	150		

S = Bearings
V = Ball bushing

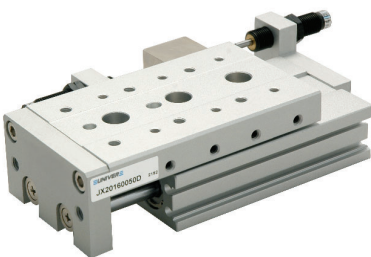
* = Theoretical thrust force at 5 bar

Ø 6 ÷ 20 mm - Pneumatic Mini Slide Unit
JX1

 Ambient temperature: -5 ÷ 60 °C
 Embodied linear guide

Part No.	Ø	Working pressure (bar)	Theoretical thrust force (N)*		Standard stroke (mm)	Sensor
			Thrust	Traction		
JX1006	6	1,2 ÷ 7	14,2	10,6	5-10-15-20-25 30-40-50-60	DF-T
JX1010	10	0,6 ÷ 7	39,3	33		
JX1016	16	0,6 ÷ 7	101	86		
JX1020	20	0,5 ÷ 7	157	132		

* = Theoretical thrust force at 5 bar

Ø 6 ÷ 25 mm - Slide Table Actuator
JX2


Ambient temperature: 0 ÷ 60 °C

Versions upon request:

with stroke adjusting screw (add suffix R to part no. e.g. JX2008R)

with hydraulic shock absorbers Ø 8 ÷ 25 (add suffix D to part no. e.g. JX2008D)

Part No.	Ø	Working pressure (bar)	Theoretical thrust force (N)*		Standard stroke (mm)	Sensor
			Thrust	Traction		
JX2006	6	1 ÷ 8,5	25	20	10-20-30-40-50	DF-T
JX2008	8		51	38	10-20-30-40-50-75	
JX2012	12		113	85	10-20-30-40-50-75-100	
JX2016	16		201	151	10-20-30-40-50-75-100-125	
JX2020	20		314	236	10-20-30-40-50-75-100-125-150	
JX2025	25		491	380	10-20-30-40-50-75-100-125-150	

* = Theoretical thrust force at 5 bar

CHARACTERISTICS

Ambient temperature	Max. 60° C
Fluid	filtered air with or without lubrication
Working pressure	2 ÷ 10 bar
Supply air ports	G1/8
Fixing	with brackets
Version	single acting, front spring
End-caps	technopolymer
Barrel	anodized aluminium
Piston rod	zinc-plated steel
Piston seals	NBR
Spring	steel








CODIFICATION KEY

M	P	0	3	5	0	0	7	5	T
1	2	3			4				

1 Series	2 Bore (mm)	3 Stroke (mm)	4 Option
MP = Clamping cylinder	035 = Ø35 040 = Ø40 (upon request)	0075 = 75 0115 = 115 Other strokes available upon request	A = orange buffer N = black buffer T = transparent buffer _ = without buffer

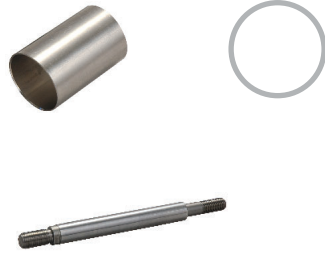
ACCESSORIES

Ø	Orange buffer	Black buffer	Trasparent buffer	Short bracket	Long bracket
35 40	 MPF-300035A	 MPF-300035N	 MPF-300035T	 MPF-310035C	 MPF-310035L

1

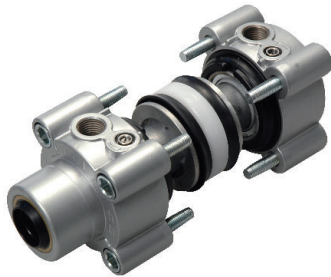
ISO 6432

- M
Ø 8 ÷ 25 mm Microcylinders

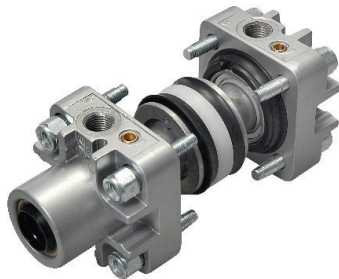


ISO 15552

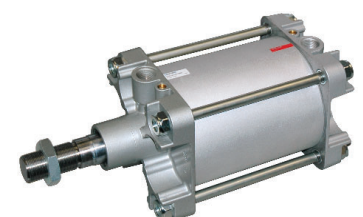
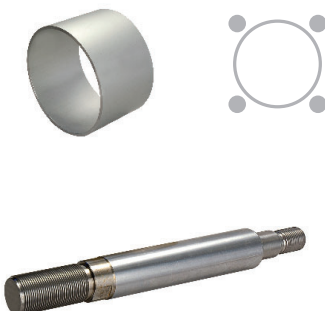
- KL
Ø 32 ÷ 125 mm Pneumatic Cylinders



- K/KE/KD
Ø 32 ÷ 125 mm Pneumatic Cylinders



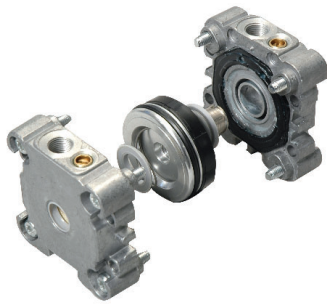
- K Ø 160-200
Ø 160 - 200 mm Pneumatic Cylinders



ISO 21287

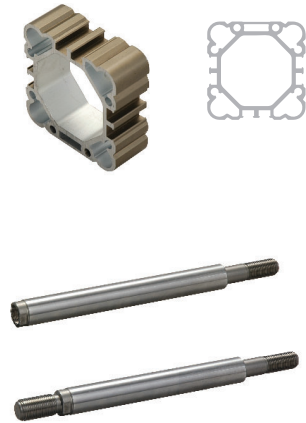
■ RP-RM

Ø 16 ÷ 100 mm Compact Cylinders



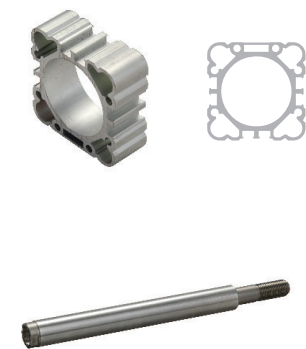
■ RO-RN

Ø 16 ÷ 63 mm Compact Cylinders



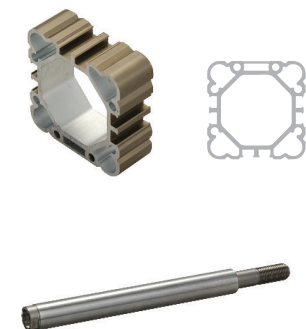
■ RS

Ø 32 ÷ 100 mm STRONG Cylinders



■ RQ

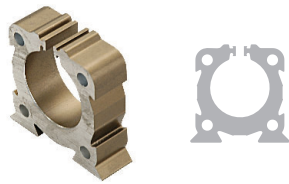
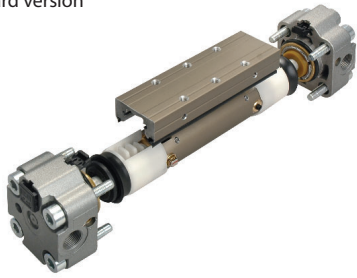
Ø 32 ÷ 63 mm STRONG Cylinders



Rodless cylinders

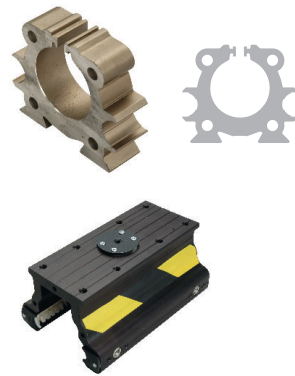
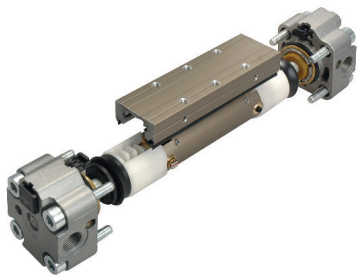
■ S1

Ø 16 ÷ 50 mm Rodless Cylinders
standard version



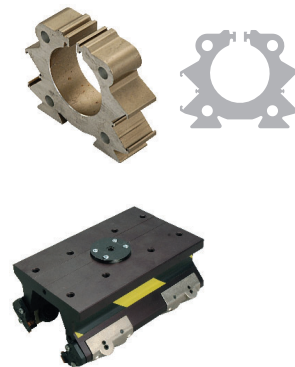
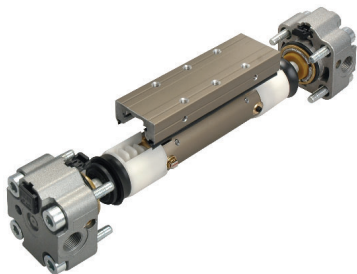
■ S5

Ø 25 ÷ 50 mm Rodless Cylinders with integrated guides
tecnopolymer sliding guide



■ VL1

Ø 25 ÷ 50 mm Rodless Cylinders with integrated guides 90°
sliding on ball bearings



2

High-Tech



Locking Units

L1-N
L6

2/3
4



Telescopic Cylinders

RT

5/6



Pneumatic Actuators

NTZ
NQZ
NFZ

8
8
9



Pneumatic Grippers

YM

10/11

ORIGINAL

Locking system UNIVER Original since 1998

STATIC/DYNAMIC

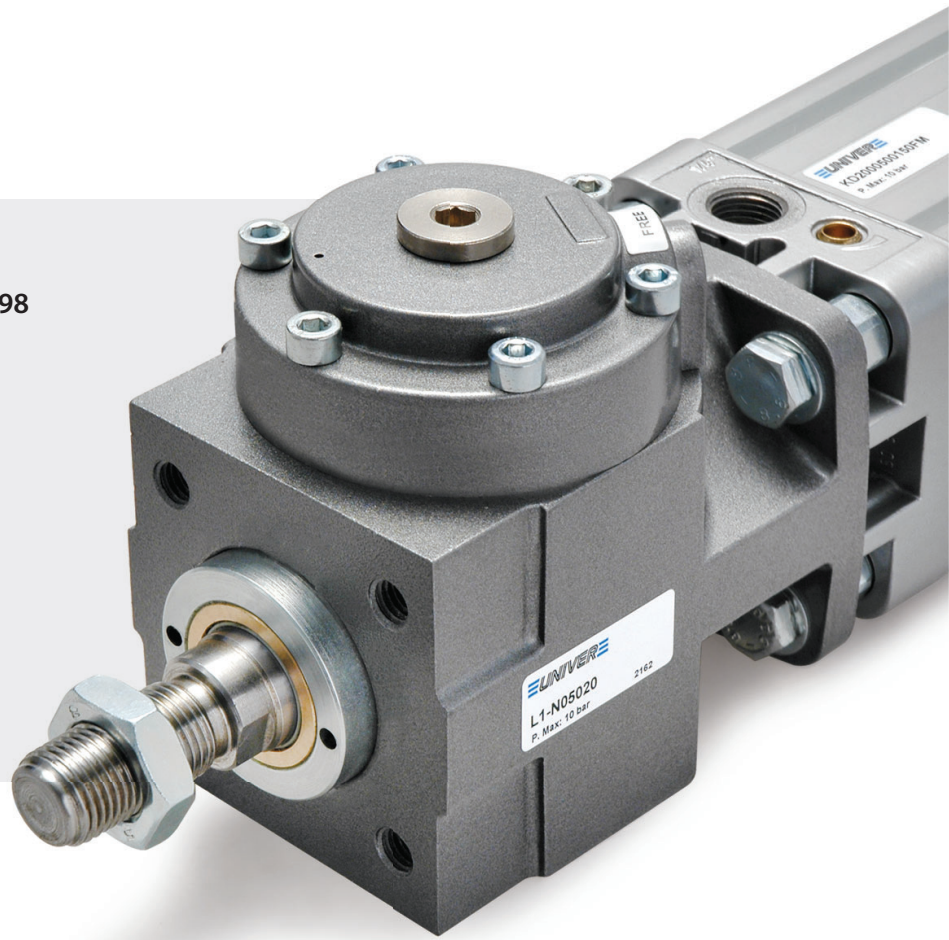
Static locking and dynamic braking in a single device

POWERFUL

The highest locking force among market equivalent devices

SAFE

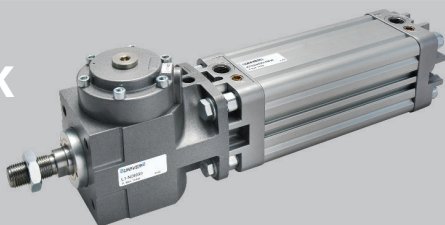
No rod slipping even if affected by oil and grease

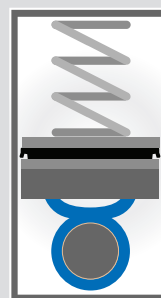

L1-N

 For cylinders $\varnothing 16 \div 125$ mm

 For piston rods $\varnothing 6 \div 32$ mm

M

**KL
KE/K
KD**

RS

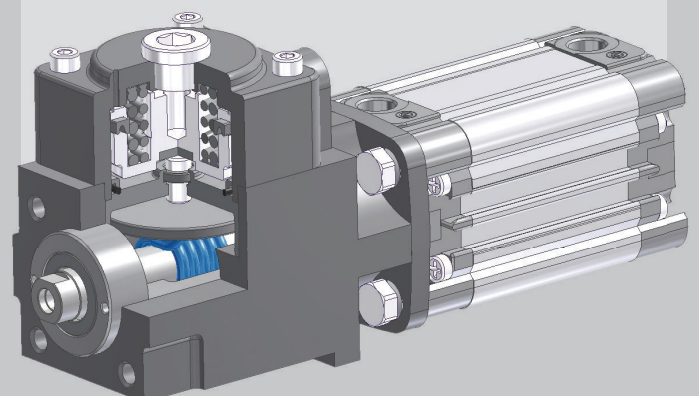
Working principle


Locked piston rod



Free piston rod

← min 4 bar



CHARACTERISTICS

Ambient temperature	-20 ÷ 30 °C
Fluid	filtered air, with or without lubrication
Working pressure	4 ÷ 10 bar
Body	die-cast aluminium
Cover	die-cast aluminium
Piston	aluminium
Seals	NBR
Springs	special steel



M, KL, KE/K, KD, RS series cylinders



CODIFICATION KEY

L	1	-	N	0	6	3	2	0		
	1			2		3	4	5		

1 Series L1-N = Locking unit for cylinders and piston rods	2 Cylinder bore (mm) 016 = Ø16 050 = Ø50 020 = Ø20 063 = Ø63 025 = Ø25 080 = Ø80 032 = Ø32 100 = Ø100 040 = Ø40 125 = Ø125	3 Piston rod bore (mm) 06 = Ø6 16 = Ø16 08 = Ø8 20 = Ø20 10 = Ø10 25 = Ø25 12 = Ø12 32 = Ø32
4 Option K = Metallic piston rod scraper upon request	5 ATEX option X = Atex (upon request) See ATEX Catalogue for types and versions	

Core features and performance

Ø	Ø rod (mm)	Static locking force	Pressure on the equivalent cylinder	Dynamic braking force	Response time at 6 bar	Stopping point repeatability	Vibration resistance	Shock resistance	Minimum release pressure
		N	bar	a 1m/s	ms	J		bar	
16	6	200	10	40% of the static locking force	12	< 1 mm at 1 m/s	10 g (10-55 Hz) for 30 minutes on each axis	2	4
20	8	314			12			3	
25	10	490			15			4	
32	12	800			20			5	
40	16	1260			20			8	
50	20	2000			25			11	
63	20	3100			25			15	
80	25	5000			30			21	
100	25	7850			30			29	
125	32	12300			40			40	

■ **NFZ 160/200**
ISO 15552 cylinders with integrated locking unit

■ Locking unit with M8 inductive position sensor

■ Customized version upon request

CHARACTERISTICS

Ambient temperature	-20 ÷ +80 °C
Fluid	filtered air, with or without lubrication
Working pressure	4,5 ÷ 10 bar
Body	die-cast aluminium
Seals	NBR
Internal parts	brass/aluminium



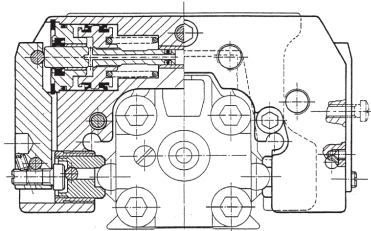
UNIVER Locking Units for rodless cylinders perform the function of keeping the carriage in any intended point of its stroke and allow high locking accuracy. They can be mounted on both sides of the carriage and the mechanical braking force can be further increased by means of an additional pneumatic override.

CODIFICATION KEY

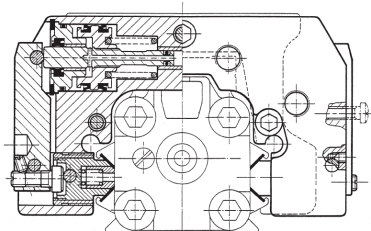
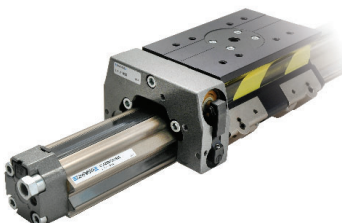
L	6	-	S	5	0	3	2
1			2			3	

1 Series	2 Type	3 Cylinder bore (mm)
L6 = Locking Unit	S5 = For S5 series rodless cylinder V1 = For VL1 series rodless cylinder	025 = Ø25 032 = Ø32 040 = Ø40 050 = Ø50

■ S5 series with locking unit



■ VL1 series with locking unit



- Min. release pressure: 4,5 bar
- Able to keep the carriage in position in both directions
- Easy to be mounted on both sides of the carriage
- Permanent manual release by means of 2 screws M5
- Locking performed by mechanical springs in absence of air
- Preset for additional pneumatic override to increase locking force

RT | Telescopic Pneumatic Cylinders

ORIGINAL

UNIVER Original design and technology

INDUSTRIALIZED

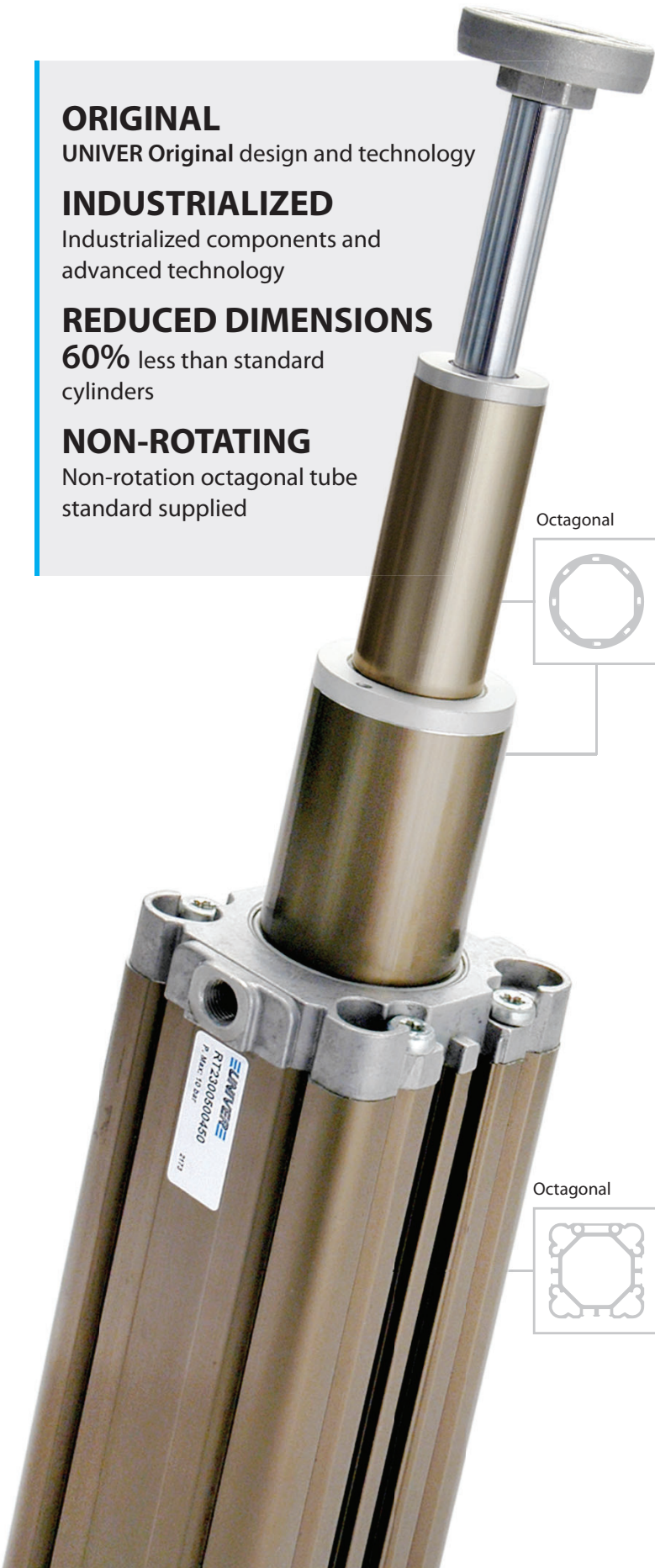
Industrialized components and advanced technology

REDUCED DIMENSIONS

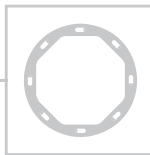
60% less than standard cylinders

NON-ROTATING

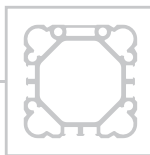
Non-rotation octagonal tube standard supplied



Octagonal

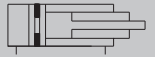


Octagonal



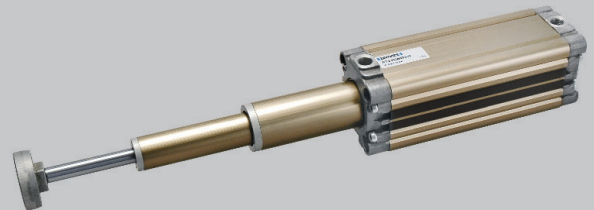
RT2

2 stages Ø 25 ÷ 63 mm

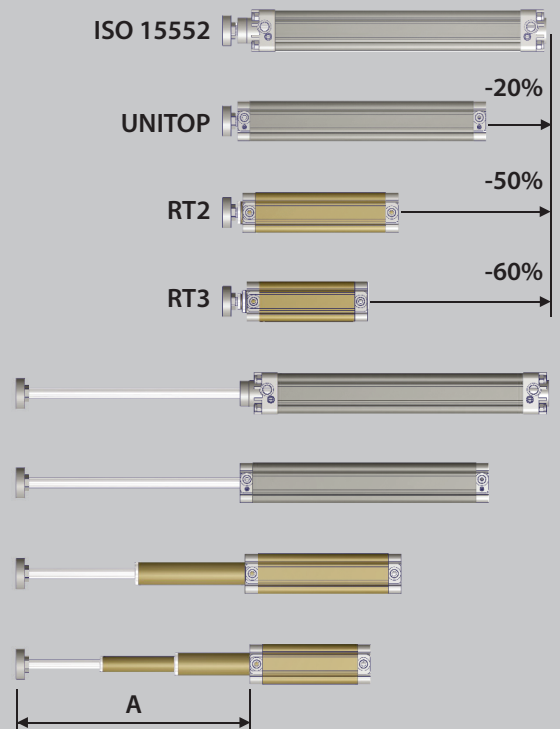


RT3

3 stages Ø 40 ÷ 63 mm

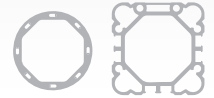
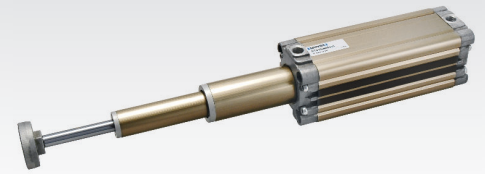


Comparison of overall dimensions stroke 300 mm (A)



CHARACTERISTICS

Ambient temperature	-20 ÷ +80 °C
Fluid	filtered air, with or without lubrication
Working pressure	1,5 ÷ 10 bar
End-caps	die-cast aluminium
Barrel	internally/externally anodized aluminium
Piston	aluminium
Guide slide	acetalic resin
Piston rod	non-rotating, chromium-plated steel, with flange (female piston rod) stainless steel upon request
Piston seals	NBR
Guide bush for piston rod	acetalic resin
Shock absorber seals	NBR
Magnet	standard supplied (stage 1)



Telescopic cylinders work under optimal conditions when the load is in axial position, i.e. when the cylinder is placed vertically, working either upward or downward. They can obviously work also horizontally and cantilevered, but in this case it is needed to:

- Reduce the maximum stroke by 50% compared to nominal maximum strokes
- Request cylinders with slide units
- Support the radial load by means of other devices such as carriages, slides or sliding guides

CODIFICATION KEY

R	T	2	2	0	0	3	2	0	6	0	0		
1	2	3	4	5		6		7	8				

1 Series	2 Rod	3 Stages	4 Type
RT = Ø 25÷63 mm - 2/3 Stage Telescopic Pneumatic Cylinders (with non-rotating piston rod and elastic shock absorber seals)	1 = Stainless steel piston rod 2 = Chromium-plated steel piston rod	2 = 2 stages 3 = 3 stages	0 = D.A. Female piston rod 3 = D.A. Male piston rod

D.A. = Double acting

5 Bore (mm)	6 Stroke (mm)	7 Option	8 ATEX Option
2 stages 025 = Ø25 032 = Ø32 040 = Ø40 050 = Ø50 063 = Ø63 3 stages 040 = Ø40 050 = Ø50 063 = Ø63	2 stages 0100 - 0120 - 0160 - 0180 - 0200 - 0300 - 0400 - 0500 0600 - 0700 - 0800 - 0900 - 1000 - 1100 - 1200 Max stroke: 0300 (Ø25) 0900 (Ø50) 0400 (Ø32) 1200 (Ø63) 0600 (Ø40) 3 stages 0150 - 0180 - 0210 - 0240 - 0270 - 0300 - 0360 - 0450 0600 - 0750 - 900 - 1050 - 1200 - 1500 - 1800 Max stroke: 1200 (Ø40) 1500 (Ø50) 1800 (Ø63)	I = Without flange (only for female piston rod) L = Freely rotating piston rod (without flange) M = With telescopic magnetic shaft (stage 2-3) except for Ø 25, only for female piston rod	X = ATEX (upon request) See ATEX Catalogue for types and versions

Nominal tolerance on stroke (mm) and maximum applicable torque (Nm) for non-rotating piston rod

Ø	Tolerances		Applicable torque	
	mm		Nm	
	2 stages	3 stages	2 stages	3 stages
25	+2/0	-	0,5	-
32	+3,2/0	-	0,8	-
40	+3,2/0	+4/0	1	0,5
50	+3,2/0	+4/0	2	0,8
63	+3,2/0	+4/0	3	1

Theoretical forces at 6 bar (N) (2 stages)

Ø	Available surface		Working pressure	
	mm ²		bar	
	thrust	traction	thrust	traction
25	201	111	123	65
32	314	201	192	123
40	490	377	300	231
50	804	603	492	369
63	1256	1055	769	649

Theoretical forces at 6 bar (N) (3 stages)

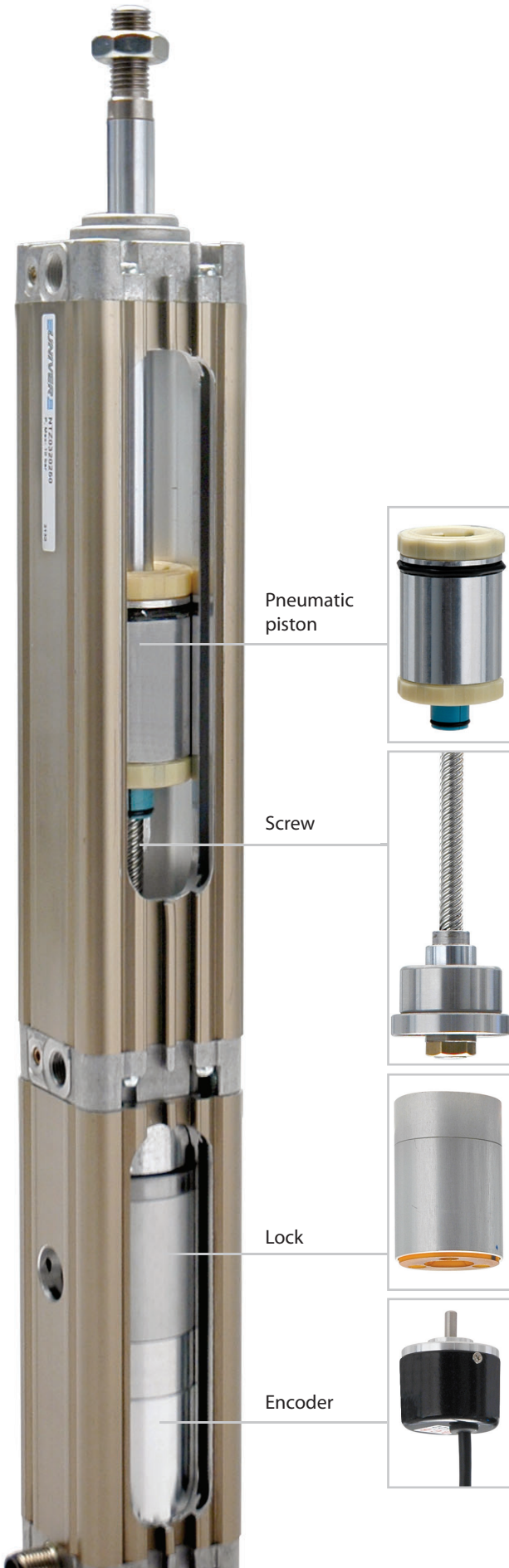
Ø	Available surface		Working pressure	
	mm ²		bar	
	thrust	traction	thrust	traction
40	201	111	123	65
50	314	201	192	123
63	490	377	300	231

FIXING ELEMENTS AND ACCESSORIES

Ø	Female hinge with pin	Counter hinge 90°	Male articulated hinge	Rear male hinge	Front / rear flange	Angle bracket	DF sensor and DHF covering strip	Cable clamping for DF sensor
25								
32	-	-	-	RPF-11025	RTF-12025	RTF-13025	DF DHF-0020100	DF-001
40	KF-10032A	KF-19032	KF-11032S	KF-11032	KF-12032	KF-13032		
50	KF-10040A	KF-19040	KF-11040S	KF-11040	KF-12040	KF-13040		
63	KF-10050A	KF-19050	KF-11050S	KF-11050	RTF-12050	RTF-13050		
63	KF-10063A	KF-19063	KF-11063S	KF-11063	RTF-12063	RTF-13063		

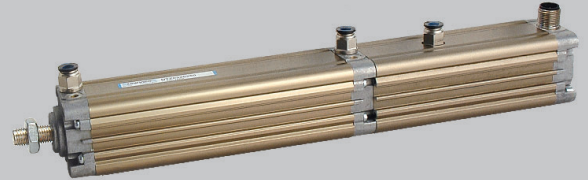
NTZ-NQZ-NFZ

Programmable Pneumatic Actuators



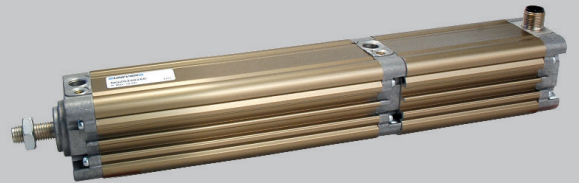
NTZ

Pneumatic actuator with integrated digital measuring detector and safety locking device
Ø 32 ÷ 63 mm



NQZ

Pneumatic actuator with digital measuring system
Ø 32 ÷ 63 mm



NFZ

Pneumatic actuator with integrated safety locking device
Ø 32 ÷ 63 mm



Pneumatic actuator with integrated digital measuring system and safety locking device

■ NTZ



The system does not need to be connected to the moving part of the mechanism, as movement is generated by an internal piston with bidirectional pneumatic function. Such piston, operated by a 5-way valve, moves autonomously until it meets the obstacle, thus measuring the stopping position. Position detection is obtained by the transformation of the translation movement of the piston rod into the rotary movement of the screw, by means of screw-female screw coupling. Then the encoder turns the rotation into a sequence of electrical impulses.

The piston and the encoder body need to be fixed, i.e. must not move regardless of screw rotation. This is the reason why the cylinder has been designed with octagonal piston and properly modified non-rotating piston rod.

The speed of the impact against the obstacle is limited by proper calibrated reducers which are embodied in the actuator, while the translation speed can be suitably controlled by means of a standard flow regulator.

For the indicated repeatability of reading to be guaranteed, the translation speed needs to be kept as constant as possible.

Main application fields are: mechanisation, palletization and automation of operating machines.

Max speed: 1 m/s

Repeatability accuracy: ± 0,3 mm

CODIFICATION KEY

N	T	Z	0	3	2	0	3	5	0
1			2			3			

1 Series	2 Bore (mm)	3 Max stroke (mm)
NTZ = Ø 32÷63 mm - Pneumatic actuator with integrated digital measuring system and safety locking device	032 = Ø32 040 = Ø40 050 = Ø50 063 = Ø63	0350 (Ø32) 0450 (Ø40) 0600 (Ø50) 0750 (Ø63)

Pneumatic actuator with digital measuring system

■ NQZ



Pneumatic actuators with digital measuring system are particularly suitable for:

- Detection of stopping position
- Anti-collision control in critical sequencing cycles
- Level control in palletization / de-palletization of piled objects
- Identification, classification and dimensional selection of objects (tolerances and rejects)
- Certification stations of machined pieces or tool breaking on machines for chip removal

The device can be used as both digital measuring detector and pneumatic actuator with digital measuring system

Max speed: 0,2 m/sec (detector) 0,8 m/sec (actuator)

Repeatability accuracy: ± 0,02 mm

CODIFICATION KEY

N	Q	Z	0	3	2	0	3	5	0
1		2			3				

1 Series	2 Bore (mm)	3 Max stroke (mm)
NQZ = Ø 32÷63 mm - Pneumatic actuator with integrated digital measuring system	032 = Ø32 040 = Ø40 050 = Ø50 063 = Ø63	0350 (Ø32) 0450 (Ø40) 0600 (Ø50) 0750 (Ø63)

Pneumatic actuator with integrated safety locking device

■ NFZ



Locking device embodied in the cylinder rear part in axial position.
High repeatability and intervention speed (16 ms).

Recommended application:

Emergency braking intervention at the speed allowed by the cylinder; for repeated functioning, as locking unit or braking intervention ≤ 50 mm/s.

Piston rod holding force (without axial backlash): ≥ 3 times the thrust of a cylinder supplied at 6 bar.
Locking force independent from ambient conditions or piston rod maintenance.
Locking device passive functioning, in absence of signal and/or air supply.

Minimum pressure: ≥ 3 bar

CODIFICATION KEY

N	F	Z	0	3	2	0	3	5	0
1			2			3			

1 Series	2 Bore (mm)	3 Max stroke (mm)
NFZ = Ø 32÷63 mm - Pneumatic actuator with integrated safety locking device	032 = Ø32 040 = Ø40 050 = Ø50 063 = Ø63	0350 (Ø32) 0450 (Ø40) 0600 (Ø50) 0750 (Ø63)

Angular Pneumatic Gripper
YMA11


Part No.	Ø	Gripping force (Nm)*		Max arm length L (mm)	Sensor
		Opening	Closing		
YMA11-10	10	0,25	0,2	30	DF-T + DF-R002
YMA11-16	16	0,6	0,45	40	
YMA11-20	20	1,15	0,85	60	
YMA11-25	25	2,25	1,7	70	

* = Gripping force at 5 bar
 L = Gripping point 30 mm

Working pressure: 1,5 ÷ 7 bar
 Ambient temperature: -5 ÷ 60 °C
 Max frequency (cycles/min): 180
 Opening angle: +30° -10°

180° Angular Pneumatic Gripper
YMA20


Part No.	Ø	Gripping force (N)*	Max arm length L (mm)	Sensor
YMA20-10	10	6	60	DF-T...
YMA20-16	16	20	70	
YMA20-20	20	36	80	
YMA20-25	25	78	90	

* = Gripping force at 5 bar
 L = Gripping point 30 mm

Working pressure: 2 ÷ 6 bar
 Ambient temperature: -10 ÷ 60 °C
 Max frequency (cycles/min): 60
 Repeatability: ± 0,2
 Opening angle: +180°~182° / -3°

Parallel Pneumatic Gripper with Linear Guide
YMP20


Part No.	Ø	Pressure (bar)	Max frequency (cycles/min)	Repeatability (mm)	Gripping force (N)*		Stroke open/close (mm)	Sensor
					Opening	Closing		
YMP20-10	10	2 ÷ 7	100	± 0,01	16	11	4	DF-T...
YMP20-16	16	1 ÷ 7	100	± 0,01	44	32	6	
YMP20-20	20	1 ÷ 7	100	± 0,01	65	42	10	
YMP20-25	25	1 ÷ 7	100	± 0,01	110	67	14	
YMP20-32	32	1 ÷ 7	60	± 0,02	193	160	22	
YMP20-40	40	1 ÷ 7	60	± 0,02	318	260	30	

* = Gripping force at 5 bar, gripping point 30 mm

Ambient temperature: 0 ÷ 60 °C

Low Profile Parallel Pneumatic Gripper with Linear Guide

■ YMP30



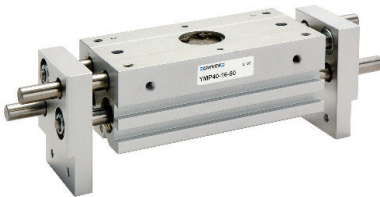
Part No.	Ø	Max frequency (cycles/min)	Gripping force (N)*		Stroke (mm)	Sensor
			Opening	Closing		
YMP30012	12	100	48	48	12-24-48	DF-T...
YMP30016	16		91	91	16-32-64	
YMP30020	20		138	138	20-40-80	

* = Gripping force at 5 bar, gripping point 30 mm

Working pressure: 1,5 ÷ 7 bar
Ambient temperature: 0 ÷ 60 °C

Wide-type Parallel Pneumatic Gripper

■ YMP40



Part No.	Ø	Max frequency (cycles/min)	Gripping force (N)*		Stroke (mm)	Sensor
			Opening	Closing		
YMP40010	10	40	14	14	20-40-60	DF-T + DF-R002
YMP40016	16	40	44	44	30-60-80	
YMP40020	20	40	77	77	40-80-100	
YMP40025	25	40	128	128	50-100-120	
YMP40032	32	20	227	227	70-120-160	

* = Gripping force at 5 bar, gripping point 30 mm

Working pressure: 1,5 ÷ 6 bar
Ambient temperature: -10 ÷ 60 °C
Repeatability: ±0,1

Self-centering 3 Jaw Pneumatic Gripper

■ YMP50



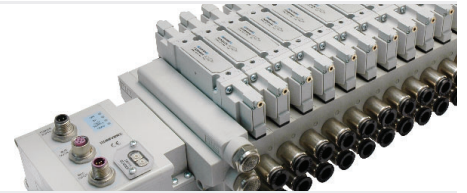
Part No.	Ø	Pressure (Bar)	Max frequency cycles/min	Gripping force (N)*		Stroke open/close (mm)	Sensor
				Opening	Closing		
YMP50-16	16	2 ÷ 6	120	16	14	4	DF-T...
YMP50-20	20	2 ÷ 6	120	28	25	4	
YMP50-25	25	2 ÷ 6	120	46	41	6	
YMP50-32	32	2 ÷ 6	60	81	73	8	DF-T + DF-R002
YMP50-40	40	2 ÷ 6	60	127	117	8	
YMP50-50	50	2 ÷ 6	60	204	187	12	
YMP50-63	63	2 ÷ 6	60	359	332	16	
YMP50-80	80	2 ÷ 6	30	520	495	20	DF-...
YMP50-100	100	2 ÷ 6	30	775	745	24	
YMP50-125	125	2 ÷ 6	30	1310	1265	32	





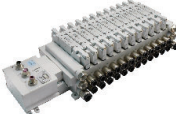





* = Gripping force at 5 bar, gripping point 20 mm (Ø16-25) 30 mm (Ø 32÷63) 50 mm (Ø 80 ÷ 125)

Ambient temperature: -10 ÷ 60 °C
Repeatability: ±0,01

3

Valves

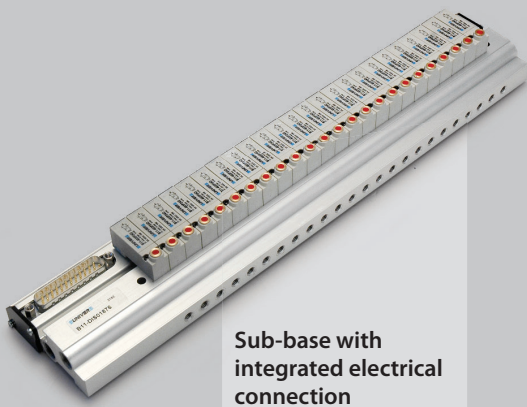


	Electropilots	B11	3
		B10	4
		B12	5
		B	7
		A	8
		AA	9
		AB	10
	Standards-based Valves	BE/BE12	11
		AE	15
		BD	16
		AC-N	22
	Spool Valves	CL/CM	23
		E	30
		F	33
		G6/GL6	34/37
		G7	41
		PS	42
	Poppet Valves	AC	47
		CH	50
		AF/AG	52/54
		AI	56
		AI-JET	57
		AI-JET2	59
	AM	60	
	COMPACT Valves	P10	61
		P15	67
		P15E	74
	ESSENTIAL Valves	EL18/22	79
	Communication systems	TC	86
	Accessories	COILS	88
		OPERATORS	90
	Certified Electropilots	CSA-UL	92
	Complementary Valves	YR	94
		AP/AM	96
		YF	98
		YG-6300	99

Standard	Low consumption	High flow rate	Magnetic memory
B11	B10	B12	LATCHING
1 w 10 NI/min	0,3 w 10 NI/min	0,6 w 28 NI/min Special version 40 NI/min	Energizing through short impulse, de-energizing through the same impulse with inverted polarity.

B11/B10/B12

ISO 15218 - 10 mm Nanovalves



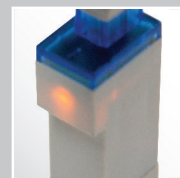
Manual override (standard)



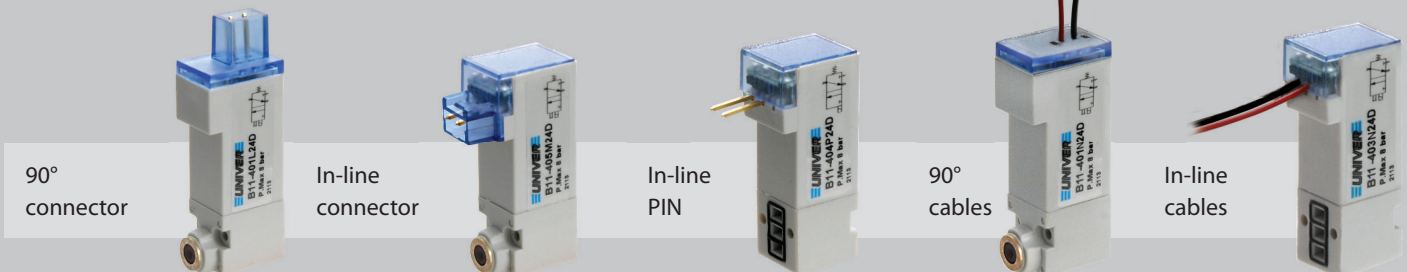
ISO 15218 interface



No manual override (upon request)



LED



CHARACTERISTICS

Ambient temperature	-5 ÷ +50 °C
Fluid	10 µm filtered air, with or without lubrication
Max pressure	7 bar
Operating frequency	5 Hz
Fixing	2 screws M1,6
Connections	ISO 15218 interface
Nominal bore (mm)	0,7 (3/2 NC) 1,3 (3/2 NO)
Nominal flow rate (NI/min)	10
Valve body	self-extinguishing technopolymer
Seals	VITON/NBR
Voltage	24 V DC (12V DC upon request)
Power consumption	1 W
Electrical connection	D-535U40 (IP65), solder pin (IP00), Molex
Led	yellow (standard)
Manual override	monostable button




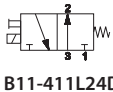

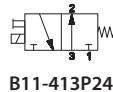
CODIFICATION KEY

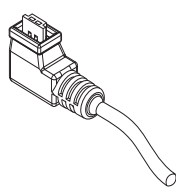
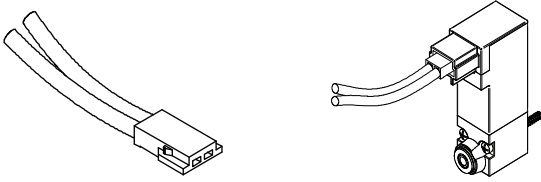
B	1	1	-	4	0	1	L	2	4	D
	1			2	3	4	5		6	

1 Series	2 Model	3 Type	4 Function
B11 = ISO 15218 - 10 mm Nanovalves - 1 W standard	4 = Monostable	0 = 3/2 NC 1 = 3/2 NO	1 = With manual override (L variant) 2 = Without manual override (L variant) 3 = With manual override (P variant) 4 = Without manual override (P variant) 5 = With manual override (M variant) 6 = Without manual override (M variant)

5 Variant	6 Voltage
L = 90° connector (protected pins) M = In-line connector protected pins (upon request) P = In-line connector (for assembly on electronic board)	24D = 24 V DC 12D = 12 V DC (upon request)

Fixing screws standard supplied. Max tightening torque 0,15 Nm
Other versions upon request: in-line cables and 90° cables

90° Connector (Protected pins)	In-line PIN
 <p>B11-401L24D</p>  <p>B11-411L24D</p>	 <p>B11-403P24D</p>  <p>B11-413P24D</p>

D-535U40300/500	D-530-30/50/200
	

Single connector with wire
D-535U40300 = wire length 300 mm
D-535U40500 = wire length 500 mm

Miniature connector with loose cables
D-530-30 = wire length 300 mm
D-530-50 = wire length 500 mm
D-530-200 = wire length 2000 mm

CHARACTERISTICS

Ambient temperature	-5 ÷ +50 °C
Fluid	10 µm filtered air, with or without lubrication
Max pressure	7 bar
Operating frequency	5 Hz
Assembly	2 screws M1,6
Connections	ISO 15218 interface
Nominal bore (mm)	0,7
Nominal flow rate (NI/min)	10
Valve body	self-extinguishing technopolymer
Seals	VITON/NBR
Voltage	24 V DC (12V DC upon request)
Power consumption	0,3 W (speed-up 1,3 W)
Electrical connection	D-535U40 (IP65), solder pin (IP00), Molex
Led	yellow (standard)
Manual override	monostable button



CODIFICATION KEY

B	1	0	-	4	0	1	L	2	4	D
	1			2	3	4	5		6	

1 Series	2 Model	3 Type	4 Function
B10 = ISO 15218 - 10 mm Nanovalves - low power consumption	4 = Monostable	0 = 3/2 NC	1 = With manual override (L variant) 2 = Without manual override (L variant) 3 = With manual override (P variant) 4 = Without manual override (P variant) 5 = With manual override (M variant) 6 = Without manual override (M variant)

5 Variant	6 Voltage
L = 90° Connector (protected PIN) M = In-line connector (protected PIN, Molex connection) P = In-line PIN (suitable for mounting on circuit boards)	24D = 24 V DC 12D = 12 V DC (upon request)

Fixing screws standard supplied. Max tightening torque 0,15 Nm
Other versions upon request: in-line cables and 90° cables

90° Connector (protected PIN)	In-line PIN	Latching in-line PIN (with magnetic memory)
<p>B10-401L24D</p>	<p>B10-403P24D</p>	<p>B10-400P24D</p> <p>This version is energized by an electrical impulse and de-energized by a similar impulse with inverted polarity.</p> <p>For further information please contact our Sales Office</p>

D-535U40300/500	D-530-30/50/200
<p>Single connector with wire D-535U40300 = wire length 300 mm D-535U40500 = wire length 500 mm</p>	<p>Miniature connector with loose cables D-530-30 = wire length 300 mm D-530-50 = wire length 500 mm D-530-200 = wire length 2000 mm</p>

CHARACTERISTICS

Ambient temperature	-5 ÷ +50 °C
Fluid	10 µm filtered air, with or without lubrication
Max pressure	7 bar
Operating frequency	5 Hz
Fixing	2 screws M1,6
Connections	ISO 15218 interface
Nominal bore (mm)	1,3
Nominal flow rate (NI/min)	28
Valve body	self-extinguishing technopolymer
Seals	VITON/NBR
Voltage	24 V DC (12 V DC upon request)
Power consumption	0,6 W (speed-up 1 W)
Electrical connection	D-535U40 (IP65), solder pin (IP00), Molex
Led	yellow (standard)
Manual override	monostable button



CODIFICATION KEY

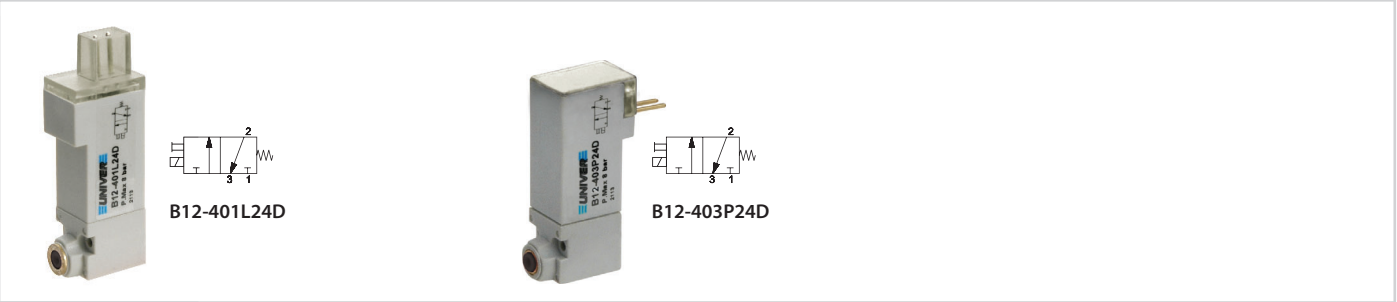
B	1	2	-	4	0	1	L	2	4	D
	1			2	3	4	5		6	

1 Series	2 Model	3 Type	4 Function
B12 = ISO 15218 - 10 mm Nanovalves - high flow rate	4 = Monostable	0 = 3/2 NC	1 = With manual override (L variant) 2 = Without manual override (L variant) 3 = With manual override (P variant) 4 = Without manual override (P variant) 5 = With manual override (M variant) 6 = Without manual override (M variant)

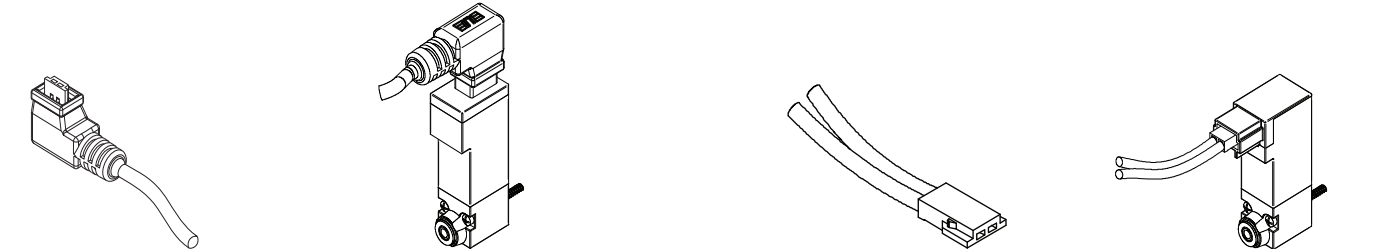
5 Variant	6 Voltage
L = 90° connector (protected PIN) M = In-line connector (protected PIN, Molex connection) P = In-line PIN (suitable for mounting on circuit boards)	24D = 24 V DC 12D = 12 V DC (upon request)

Fixing screws standard supplied. Max tightening torque 0,15 Nm
Other versions (upon request): In-line cables and 90° cables, nominal flow rate 40 NI/min

90° Connector (protected PIN) In-line PIN



D-535U40300/500 D-530-30/50/200



Single connector with wire
D-535U40300 = wire length 300 mm
D-535U40500 = wire length 500 mm

Miniature connector with loose cables
D-530-30 = wire length 300 mm
D-530-50 = wire length 500 mm
D-530-200 = wire length 2000 mm

B 10 mm

1,2 w
12 NI/min



A 15 mm

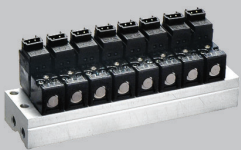
2 w
38 NI/min



DETENT SYSTEM UNIVER Original since 1988

B 10 mm

3/2 NC - NO



Revolving coil
180° x 180°



Manual
override



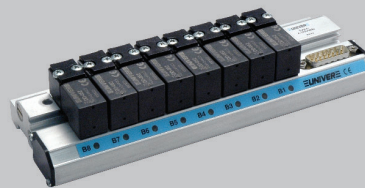
Atmosphere
exhaust



Conveyed
exhaust

A 15 mm

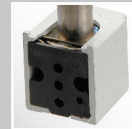
2/2 NC - NO, 3/2 NC - NO



Revolving coil
90° x 90°



Manual
override



ISO 15218
interface



90° connector



In-line connector



Loose cables



Faston



90° connector



In-line connector



Loose cables

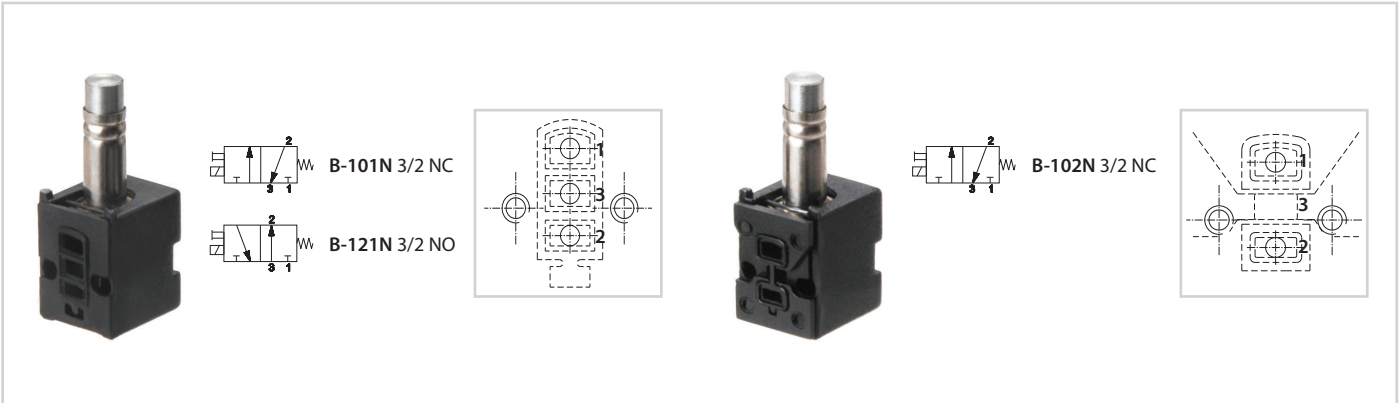
CHARACTERISTICS

Ambient temperature	-5 ÷ +50 °C	
Fluid	10 µm filtered air, with or without lubrication	
Commutation system	poppet	
Max pressure	8 bar	
Fixing	2 screws M1,6	
Connections	on sub-base	
Nominal bore (mm)	0,5	0,6
Nominal flow rate (NI/min)	9	12
Max frequency	2300 ÷ 3000 cycles/min	
Valve body	technopolymer (aluminium external cover)	
Seals	NBR	
Power consumption	1,2 W (1,35 W with LED) - 0,5 W (speed-up 1,2 W)	
Electrical connection	Molex bipolar connector or loose cables	
Voltage	12 V DC - 24 V DC	
Manual override	recessed button - 1 position	



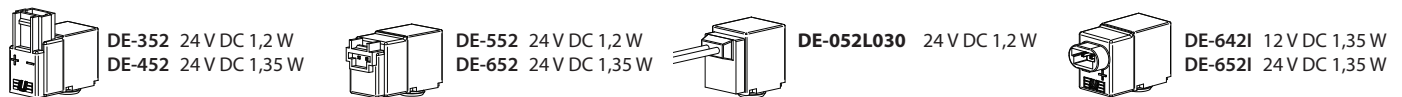
Valves with conveyed exhaust

Valves with atmosphere exhaust



Revolving coil 180°x180°

Coils



Coil with 90° upward connector
12 V DC upon request

Coil with integrated in-line connector
12 V DC upon request

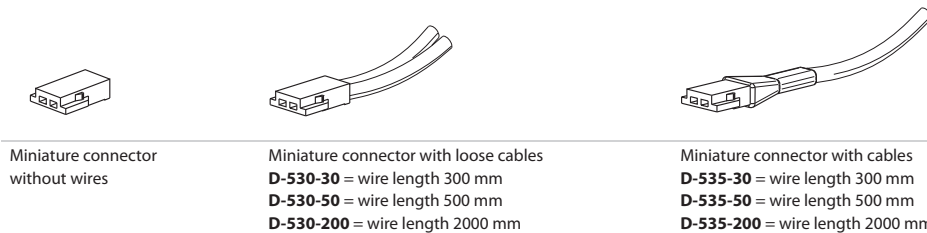
Coil with loose cables
12 V DC upon request

Coil with in-line connector with protection
for a complete tightness

D-500

D-530-30/50/200

D-535-30/50/200



Miniature connector
without wires

Miniature connector with loose cables
D-530-30 = wire length 300 mm
D-530-50 = wire length 500 mm
D-530-200 = wire length 2000 mm

Miniature connector with cables
D-535-30 = wire length 300 mm
D-535-50 = wire length 500 mm
D-535-200 = wire length 2000 mm



Solenoid valves are supplied without coil and connector
See ATEX Catalogue for types and versions

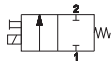
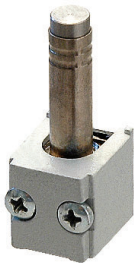
CHARACTERISTICS

Ambient temperature	-5 ÷ +50 °C
Fluid	10 µm filtered air, with or without lubrication
Commutation system	poppet
Max pressure	9 bar
Fixing	nr. 2 screws M3
Connections	ISO 15218 interface
Nominal bore (mm)	1,2 1,5
Nominal flow rate (NI/min)	26 38
Max frequency	2700 cycles/min
Valve body	technopolymer (aluminium external cover)
Seals	NBR
Power consumption	2 W DC / 2,3 VA AC (Ø 1,2) - 2,5 W DC / 3,5 VA AC (Ø 1,5)
Electrical connection	15 mm connector - Molex bipolar connector or loose cables
Voltage	24 V DC - 12 V DC - 24 V AC - 110 V AC - 230 V AC
Manual override	recessed button - 1 position (other manual overrides upon request)
Protection degree with connector	IP65



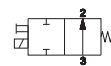
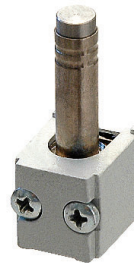
15 mm Microvalves

■ NC



	Ø	Voltage
A-141N	1,2	2 W DC
A-142N	1,5	2,5 W DC
A-151N	1,2	V DC/AC 2W/2 VA
A-101N	1,2	2 W DC
A-102N	1,5	2,5 W DC
A-111N	1,2	V DC/AC 2W/2 VA
A-112N	1,5	V DC/AC 2,5W/3,5 VA

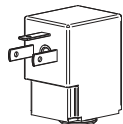
■ NO



	Ø	Voltage
A-161N	1,2	2 W DC
A-162N	1,5	2,5 W DC
A-171N	1,2	V DC/AC 2W/2 VA
A-121N	1,2	2 W DC
A-122N	1,5	2,5 W DC
A-131N	1,2	V DC/AC 2W/2 VA

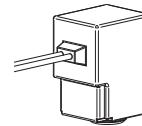
Revolving coil 90°x90°

Coils



DD-013	230 V AC - 50/60 Hz - 3,5 VA
DD-040	24 V AC - 50/60 Hz - 2,3 VA
DD-041	12 V DC - 2 W
DD-042	12 V DC 2,5 W
DD-050	48 V AC - 50/60 Hz - 2,3 VA

DD-051	24 V DC - 2 W
DD-052	24 V DC - 2,5 W
DD-060	110 V AC - 50/60 Hz - 2,3 VA
DD-070	230 V AC - 50/60 Hz - 2,3 VA



DD-051L030	24 V DC - 2 W
DD-052L030	24 V DC - 2,5 W

24 V DC Faston connector
12 V DC upon request

24 V DC Coil with loose cables
12 V DC upon request

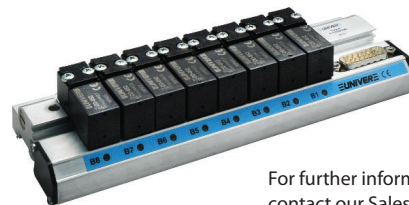
Sub-base for external electrical connection



- A - 326A - __ G1/8 (standard)
- A - 326B - __ M5 (upon request)
- A - 326D - __ tube 4 (upon request)

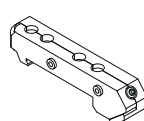
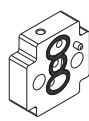
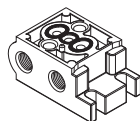
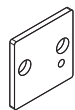
__ = Number of positions

Sub-base for integrated electrical connection



For further information please contact our Sales Office

A-299-11 A-301 A-305 A-350 A-345



Sealing plate

Blank end-plate

Single base

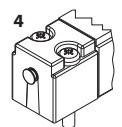
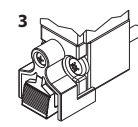
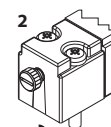
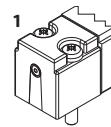
Inverter plate

46277/3
(EN50022) DIN
rail adaptor

Solenoid valves are supplied without coil and connector
See ATEX Catalogue for types and versions

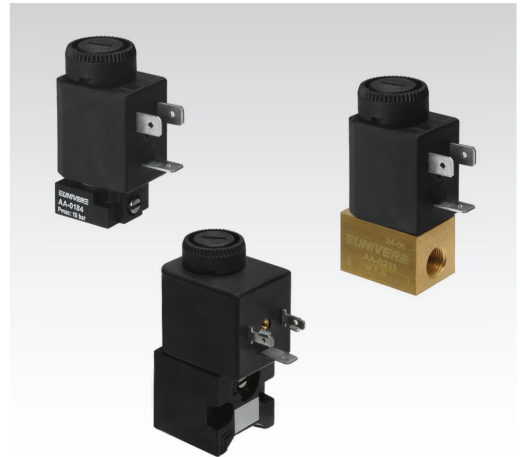
Manual override

- 1 = Recessed button - 1 position (standard supplied) →
- 2 = Impulse screw - 1-2 positions (upon request) ⊖
- 3 = Front button - 1 position (upon request) →
- 4 = Key button - 1 position (upon request) →



CHARACTERISTICS

Ambient temperature	-10 ÷ +50 °C			
Fluid	50 µm filtered air, with or without lubrication; neutral gases (versions for different fluids available upon request)			
Commutation system	direct intervention poppet with cushioned seals			
Pressure	0 ÷ 10 bar (2/2, 3/2 NC), 3 ÷ 10 bar (3/2 NO)			
Connections	on sub-base / threaded on the body			
	sub-base	G 1/8	M5	CNOMO
Nominal bore (mm)	1,2 ÷ 1,5	1 ÷ 1,5	1 ÷ 1,5	1,2 ÷ 1,5
Nominal flow rate (NI/min)	30 ÷ 60	28 ÷ 60	30 ÷ 60	33 ÷ 45
Power consumption	3,5 W (DC) - 5 VA (AC)		2,5 W (DC) - 3,3 VA (AC)	
Connector	AM-5110		AM-5111	
Sleeve	U1			
Coil	DA - DC			
Voltage	12 V DC - 24 V DC - 24 V AC - 110 V AC - 230 V AC			
Protection degree	IP65			



U1 Sleeves - with moving core

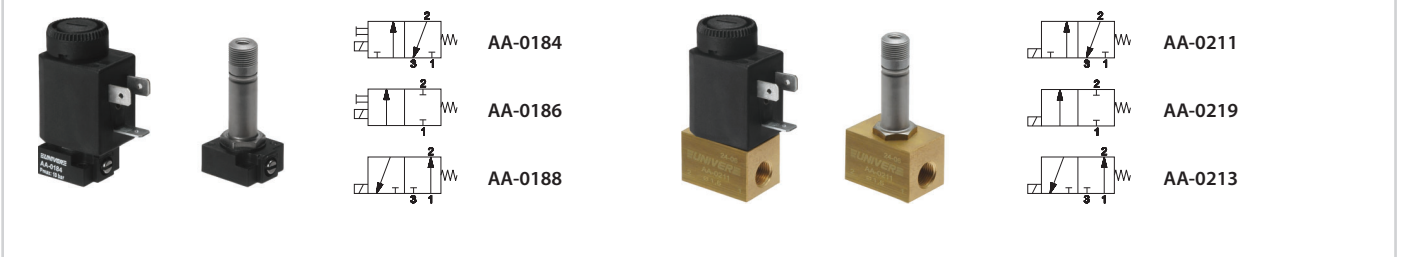
Coil-sleeve locking nuts



2/2 - 3/2 U1 Electropilot

2/2 - 3/2 U1 Electropilot G1/8

■ For mounting on U1 G1/8 sub-base



2/2 - 3/2 U1 Electropilot M5

2/2 - 3/2 U1 CNOMO Electropilot

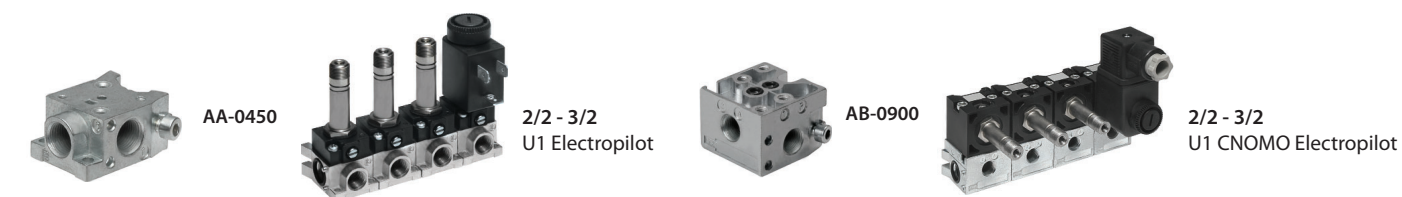
■ For mounting on U2 G1/8 SPEED sub-base



SPEED Series modular sub-base

■ U1 sub-base G1/8

■ CNOMO sub-base G1/8



Manual override:

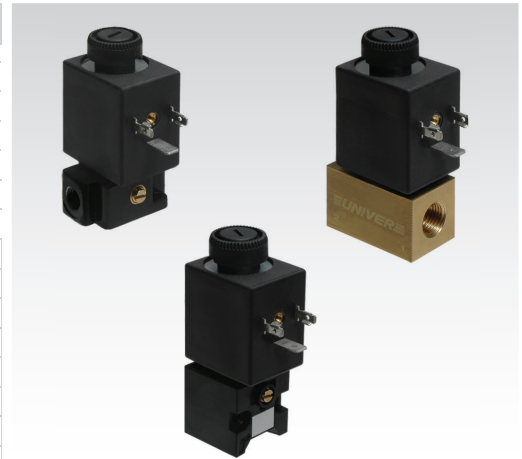
Impulse screw – 2 positions (standard supplied), Recessed button - 1 position, Impulse screw - 1-2 positions, Locking nut with button – 1 position (upon request)

Solenoid valves are supplied without coil, connector and locking nuts

See ATEX Catalogue for types and versions

CHARACTERISTICS

Ambient temperature	-10 ÷ +50 °C			
Fluid	10 µm filtered air, with or without lubrication; neutral gases (versions for different fluids available upon request)			
Commutation system	direct intervention poppet with cushioned seals			
Pressure	0 ÷ 10 bar (2/2, 3/2 NC), 3 ÷ 10 bar (3/2 NO)			
Connections	on sub-base / threaded on the body			
	sub-base	G 1/8	G1/4	CNOMO
Nominal bore (mm)	2,1 ÷ 2,4	2,1 ÷ 2,4	1,6 ÷ 6	2,1 ÷ 2,4
Nominal flow rate (NI/min)	92 ÷ 150	100 ÷ 155	95 ÷ 650	92 ÷ 110
Power consumption	11W (DC) - 10 VA (AC)			
Connector	AM-5111			
Sleeve	U2			
Coil	DB			
Voltage	12 V DC - 24 V DC - 24 V AC - 110 V AC - 230 V AC			
Protection degree	IP65			



U2 Sleeves - with moving core

Coil-sleeve locking nuts



AB-0600 3/2 NO
AB-0613 3/2 NC
AB-0640 2/2 NC^(a)
AB-0643 2/2 NC

(a) = Suitable for bases with diameter 3 ÷ 6 mm

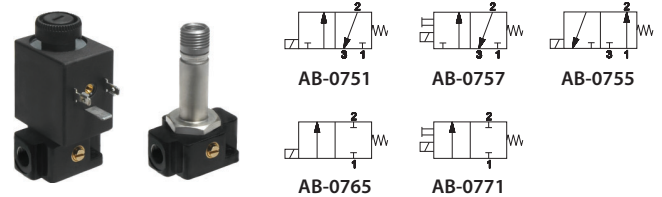
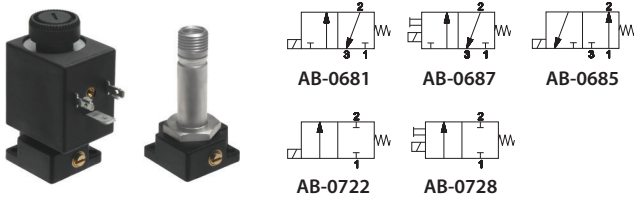


AM-5214A 3/2 NO
AM-5212A 3/2 NC
AM-5212B 2/2 NC

2/2 - 3/2 U2 Electropilot

2/2 - 3/2 U2 Electropilot G1/8

■ For mounting on U2 sub-base G1/8



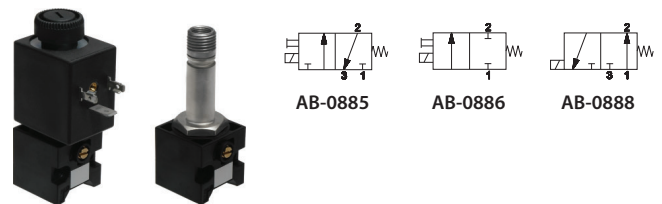
2/2 - 3/2 U2 Electropilot G1/4

2/2 - 3/2 U2 CNOMO Electropilot

Model	Ø	Max Pressure (bar)
AB-0824	1,6	30
AB-0825	2	20
AB-0826	2,4	15
AB-0827	3	10
AB-0828	3,5	9
AB-0829	4	8
AB-0830	4,5	7
AB-0831	5	6,5
AB-0832	5,5	6
AB-0833	6	5

■ U2 - 17 VA Coil for version 2/2
DB-0607 24V AC - 50/60 Hz
DB-0608 110V AC - 50/60 Hz
DB-0610 230V AC - 50/60 Hz

■ For mounting on U2 G1/8 SPEED sub-base



The bore (mm) indicated on 3/2 valves refers to the exhaust

SPEED Series modular sub-base

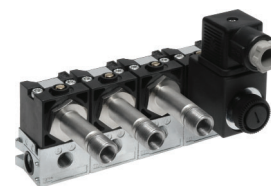
■ U2 G1/8 sub-base



AB-0900



2/2 - 3/2
U2 Electropilot



2/2 - 3/2
U2 CNOMO Electropilot

Manual override:

Impulse screw - 2 positions (standard supplied). Recessed button - 1 position, Impulse screw - 1-2 positions, Locking nut with button - 1 position (upon request)

Solenoid valves are supplied without coil, connector and locking nuts

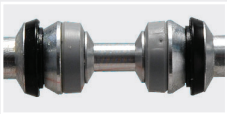
See ATEX Catalogue for types and versions

ORIGINAL

Valves and sub-bases UNIVER Original since 1980

MIXED and SPOOL SYSTEM

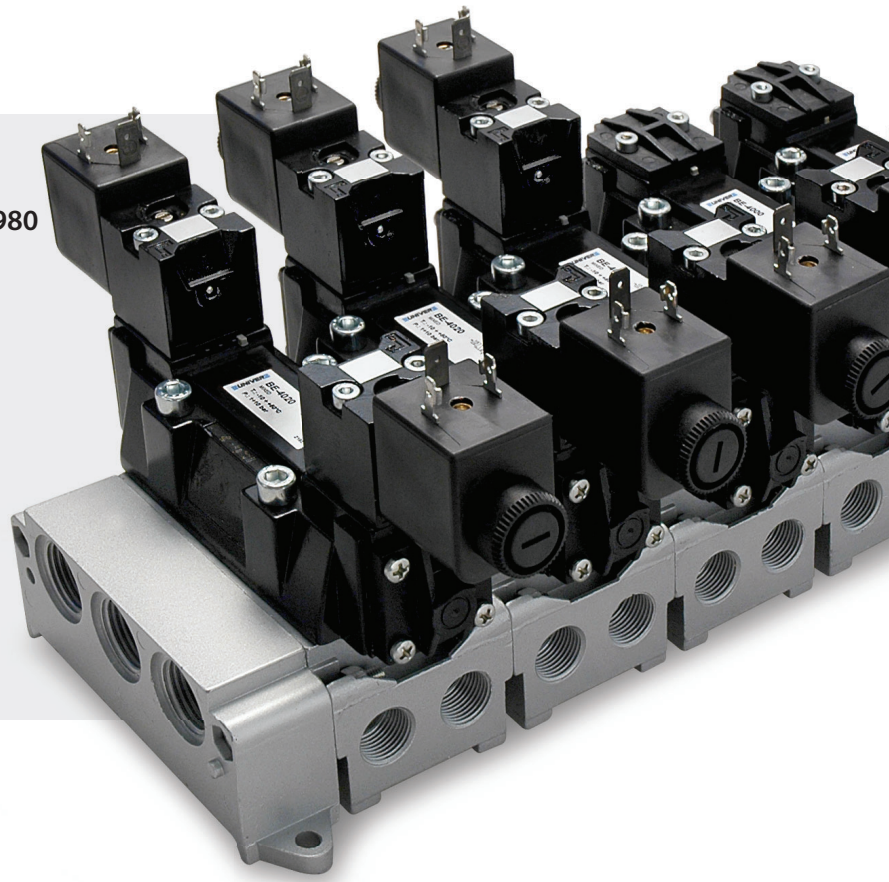
Versions with either mixed or spool system available for all series



MIXED
for heavy applications

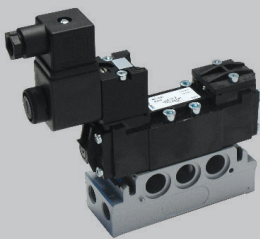


SPOOL
for all applications



BE 3

ISO 1

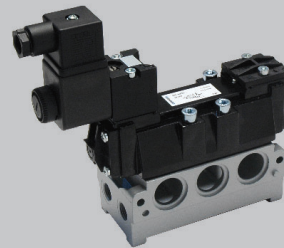


M12

1480
NI/min

BE 4

ISO 2

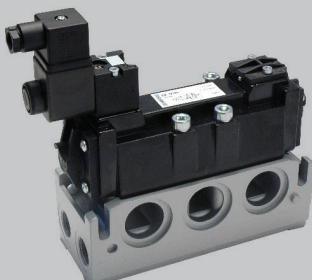


M12

2300
NI/min

BE 5

ISO 3

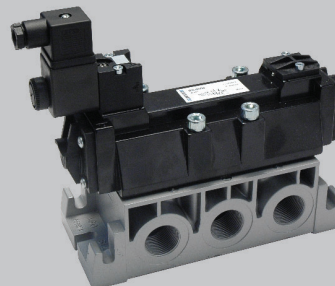


M12

4200
NI/min

BE 6

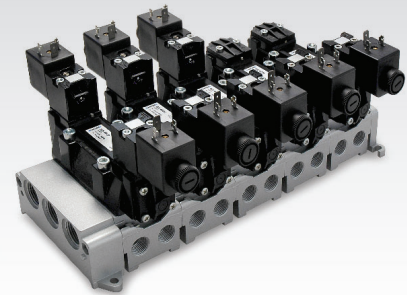
ISO 4



6600
NI/min

CHARACTERISTICS

Ambient temperature	-10 ÷ +50 °C			
Fluid	50 µm filtered air (mixed system) 50 µm filtered air, with or without lubrication (spool system)			
Commutation system	mixed and spool			
Max pressure	10 bar			
Connection	ISO 5599/1 interface			
	size 1	size 2	size 3	size 4
Nominal bore (mm)	8	10	15	19
Nominal flow rate (NI/min)	1480	2300	4200	6600
Valve body	acetalic resin with zamak cover			
Seals	NBR and polyurethane (mixed system), NBR (spool system)			
Electropilot/Coil	AA series/U3			
Power consumption	2,5 W (DC) - 5 VA (AC)			
Voltage	12 V DC - 24 V DC - 24 V AC - 110 V AC - 230 V AC			
Manual override	impulse screw - 2 positions (BE), recessed button - 1 position (BE12)			



BE Single/double pneumatic impulse

	■ MIXED SYSTEM		size		size		size
		BE-3100 1 BE-4100 2 BE-5100 3 BE-6100 4			BE-3150 1 BE-4150 2 BE-5150 3 BE-6150 4		BE-3170 1 BE-4170 2 BE-5170 3 BE-6170 4
	■ SPOOL SYSTEM		size		size		size
		BE-3800 1 BE-4800 2 BE-5800 3 BE-6800 4			BE-3850 1 BE-4850 2 BE-5850 3 BE-6850 4		BE-3870 1 BE-4870 2 BE-5870 3 BE-6870 4

BE Single electrical impulse

	■ MIXED SYSTEM		size		size
		BE-3000 1 BE-4000 2 BE-5000 3 BE-6000 4			BE-3060 1 BE-4060 2 BE-5060 3 BE-6060 4
	■ SPOOL SYSTEM		size		size
		BE-3700 1 BE-4700 2 BE-5700 3 BE-6700 4			BE-3760 1 BE-4760 2 BE-5760 3 BE-6760 4

BE Double electrical impulse

	■ MIXED SYSTEM		size		size
		BE-3020 1 BE-4020 2 BE-5020 3 BE-6020 4			BE-3030 1 BE-4030 2 BE-5030 3 BE-6030 4
		BE-3200* 1 BE-4200* 2 BE-5200* 3 BE-6200* 4			BE-3205 1 BE-4205 2 BE-5205 3 BE-6205 4
	■ SPOOL SYSTEM		size		size
	BE-3720 1 BE-4720 2 BE-5720 3 BE-6720 4			BE-3730 1 BE-4730 2 BE-5730 3 BE-6730 4	
		size		size	
	BE-3900 1 BE-4900 2 BE-5900 3 BE-6900 4			BE-3940 1 BE-4940 2 BE-5940 3 BE-6940 4	

* = For version with manual override contact our Sales Department

For versions with recessed button 1 position, add suffix U to part number
Solenoid valves are supplied without coil, connector and locking nuts
See ATEX Catalogue for types and versions

BE12 Single electrical impulse

	■ MIXED SYSTEM	size	■ SPOOL SYSTEM	size
		BE12-3000 1 BE12-4000 2 BE12-5000 3		BE12-3700 1 BE12-4700 2 BE12-5700 3

BE12 Double electrical impulse

	■ MIXED SYSTEM	size	■ SPOOL SYSTEM	size	size
		BE12-3020 1 BE12-4020 2 BE12-5020 3		BE12-3720 1 BE12-4720 2 BE12-5720 3	BE12-3940 1 BE12-4940 2 BE12-5940 3
		size		size	
	BE12-3205 1 BE12-4205 2 BE12-5205 3		BE12-3900 1 BE12-4900 2 BE12-5900 3		

Single sub-base, side connections

■ ISO 1		BF-1060 G1/8 BF-1061 G1/4	■ ISO 2		BF-1150 G1/4 BF-1151 G3/8	■ ISO 3		BF-3060 G1/2 BF-3061 G3/4	■ ISO 4		BF-4060 G3/4 BF-4061 G1
---------	--	------------------------------------	---------	--	------------------------------------	---------	--	------------------------------------	---------	--	----------------------------------

Single sub-base, bottom connections

■ ISO 1		BF-1062 G1/8 BF-1063 G1/4	■ ISO 2		BF-1152 G1/4 BF-1153 G3/8
---------	--	------------------------------------	---------	--	------------------------------------

Single or Manifold with separate exhausts

■ ISO 4		BF-4062 G3/4 BF-4063 G1
---------	--	----------------------------------

Manifold universal system sub-base, bottom and side connections, conveyed exhaust

■ ISO 1		BF-1071 G1/8 BF-1072 G1/4 BF-1071S G1/8 BF-1072S G1/4	■ ISO 2		BF-1160 G1/4 BF-1161 G3/8	■ ISO 3		BF-3071 G1/2 BF-3072 G3/4
---------	--	--	---------	--	------------------------------------	---------	--	------------------------------------

Manifold universal system inlet plate

ISO 1



BF-1065
G3/8
Upper
connections

BF-1066
G3/8
Back
connections



BF-1068
G3/8
In-line
connections

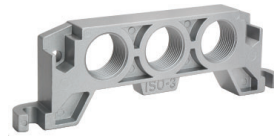
ISO 2



BF-1154
G1/2
Side
connections

BF-1155
G1/2
Back
connections

ISO 3



BF-3064
G1
In-line
connections

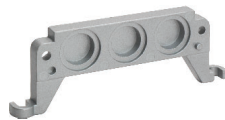
Manifold universal system diaphragm

ISO 1



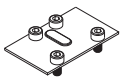
BF-1070

ISO 2



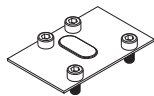
BF-1162

BF-1085



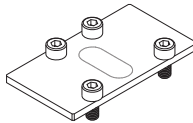
closing plate for
ISO 1 sub-base

BF-1175



closing plate for
ISO 2 sub-base 2

BF-3175



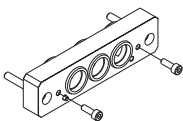
closing plate for
ISO 3 sub-base 3

BF-3082



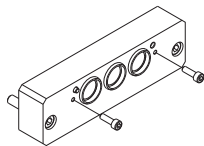
universal system plug for
ISO 3 sub-base

BF-1190



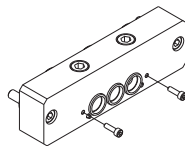
connecting interface for
universal sub-bases
size 1 - 2

BF-3190



connecting interface for
universal sub-bases
size 2 - 3

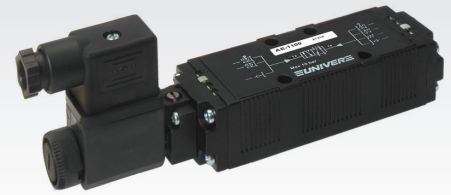
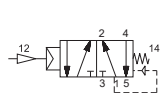
BF-3191



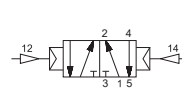
connecting interface for
universal sub-bases
size 1 - 3

CHARACTERISTICS

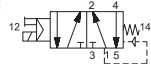
Ambient temperature	-10 ÷ +50 °C	
Fluid	50 µm filtered air, with or without lubrication	
Commutation system	mixed	
Max pressure	10 bar	
Connections	BF series sub-bases	
	size 1	size 2
Nominal bore (mm)	8	10
Nominal flow rate (NI/min)	1480	2300
Valve body	acetalic resin	
Seals	NBR, polyurethane	
Electropilot/Coil	AA series/U1	
Power consumption	3,5 W (DC) - 5 VA (AC)	
Voltage	12 V DC - 24 V DC - 24 V AC - 110 V AC - 230 V AC	
Connector	AM-5110	
Manual override	impulse screw - 2 positions	


Single/double pneumatic impulse


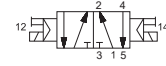
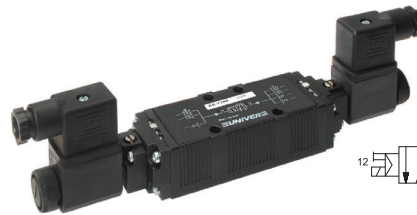
	size
AE-1009	1
AE-1120	2



	size
AE-1010	1
AE-1121	2

Single electrical impulse


	size
AE-1000	1
AE-1100	2

Double electrical impulse


	size
AE-1003	1
AE-1103	2

ISO 1 Sub-base and plate

BF-1060
G1/8

BF-1061
G1/4

BF-1062
G1/8

BF-1063
G1/4

BF-1071
G1/8
BF-1072
G1/4

BF-1071S
G1/8
BF-1072S
G1/4

BF-1065 On top
BF-1066 Rear
BF-1068 In line
G3/8

BF-1070
ISO 2 Sub-base and plate

BF-1150
G1/4

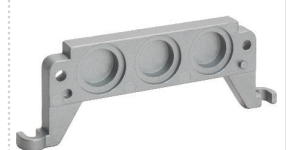
BF-1151
G3/8

BF-1152
G1/4

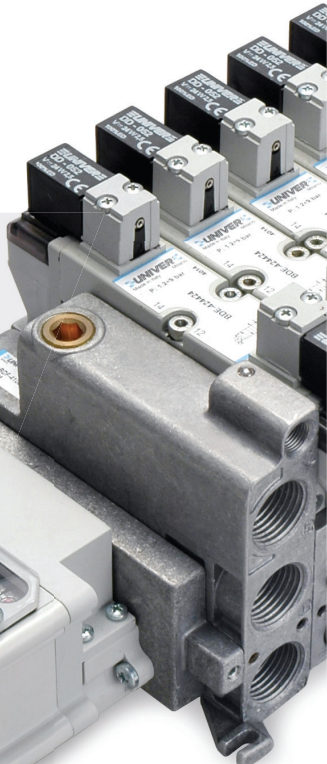
BF-1153
G3/8

BF-1160
G1/4

BF-1161
G3/8

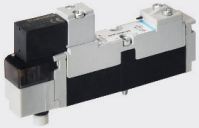
BF-1154 In line
BF-1155 Rear
G1/2

BF-1162

Solenoid valves are supplied without coil, connector and locking nuts
 See ATEX Catalogue for types and versions



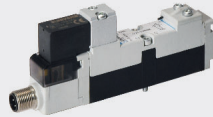
BDE

Integrated electrical connection (ISO 15407/2)

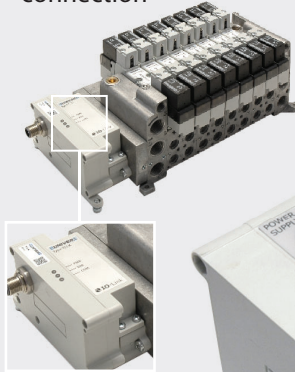


BDB

M12 connector (Automotive)



Available with **IO-Link** connection



BDA

Single electrical connection (ISO 15407/1)



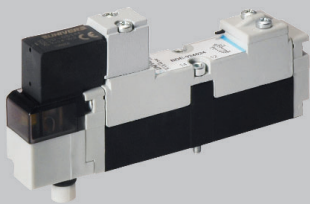
BDA

Pneumatic connection (ISO 15407/1)

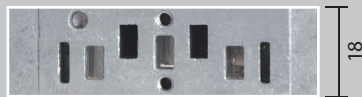


ISO 02

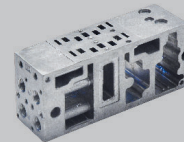
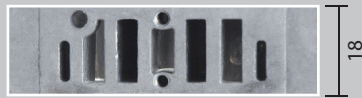
18 mm



ISO Interface



OVERSIZED interface (UNIVER original)



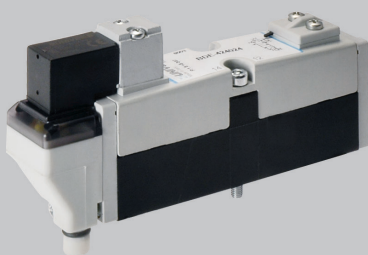
620
NI/min



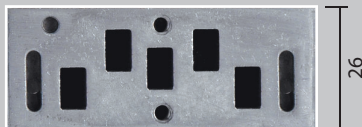
800
NI/min

ISO 01

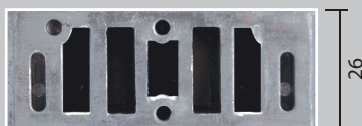
26 mm



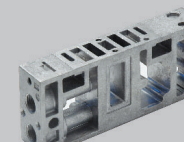
ISO Interface



OVERSIZED interface (UNIVER original)



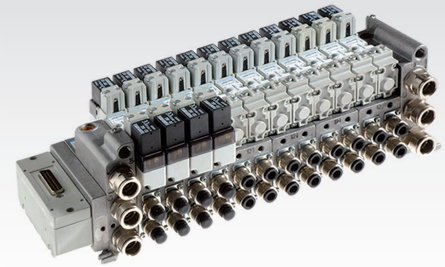
1250
NI/min



1700
NI/min

CHARACTERISTICS

Ambient temperature	-20 ÷ +50 °C
Fluid	50 µm filtered air, with or without lubrication
Commutation system	spool
Max pressure	9 bar (electrical) 10 bar (pneumatic)
Connections	ISO 15407-1/2 interface
Nominal bore (mm)	6 (18 mm) 8 (26 mm)
Nominal flow rate (NI/min)	see table below
Valve body	acetalic resin with aluminium cover
Seals	NBR
Spool	aluminium
Electropilot/Coil	A series/U05
Voltage	12 V DC - 24 V AC/DC - 48 V AC - 110 V AC - 230 V AC
Power consumption	2 W
Manual override	recessed button - 1 position
Protection degree	IP65


CODIFICATION KEY

B	D	E	-	3	3	4	4	2	4	
1				2	3	4	5	6		7

1 Series	2 Size	3 Type
BDE = Solenoid valves with integrated electrical connection 24 V DC	BDB = Solenoid valves with electrical connection 24 V DC, with connector M12	2 = 5/2 3 = 5/3 c.c. 4 = 5/3 o.c. 5 = 5/3 p.c. 6 = 3/2+3/2 NC-NC 7 = 3/2+3/2 NC-NO 8 = 3/2+3/2 NO-NO

Coils and connectors included

4 Control 14	5 Return 12	6 Coil voltage	7 Options
4 = Electrical amplified	0 = Pneumomechanical spring 1 = Mechanical spring 4 = Electrical amplified 7 = Electrical not amplified	24 = 24 V DC (standard) 12 = 12 V DC (upon request)	D = External pilot supply

B	D	A	-	3	3	4	4		
1				2	3	4	5	6	7

1 Series	2 Size	3 Type	4 Control 14
BDA = Valves and solenoid valves	3 = 18 mm 4 = 26 mm	2 = 5/2 3 = 5/3 c.c. 4 = 5/3 o.c. 5 = 5/3 p.c. 6 = 3/2+3/2 NC-NC 7 = 3/2+3/2 NC-NO 8 = 3/2+3/2 NO-NO	3 = Pneumatic amplified 4 = Electrical amplified only DC 5 = Electrical amplified DC/AC

Coils and connectors not included, to be purchased separately

5 Return 12	6 Options	7 ATEX option
0 = Pneumomechanical spring 1 = Mechanical spring 2 = Pneumatic not amplified 3 = Pneumatic amplified	4 = Electrical amplified only DC 5 = Electrical amplified DC/AC 7 = Electrical not amplified only DC 8 = Electrical not amplified DC/AC	D = External pilot supply X = Atex (upon request) See ATEX Catalogue for types and versions

c.c. = closed centres o.c. = open centres p.c. = pressurized centres

U05 Coils side 15 mm

Part No.	Nominal voltage		Frequency	Power consumption			
	V DC	V AC		DC W		AC VA	
			HZ	hold	speed-up	hold	speed-up
DD-040	-	24	50/60	-	-	2,3	3,2
DD-041	12	-	-	2	2	-	-
DD-050	-	48	50/60	-	-	2,3	3,2
DD-051	24	-	-	2	2	-	-
DD-060	-	110	50/60	-	-	2,3	3,2
DD-070	-	230	50/60	-	-	2,3	3,2

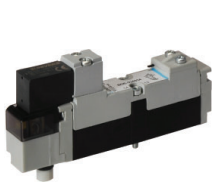
Nominal flow rate (NI/min)

BD 18 mm	VDMA-ISO			Oversized		
	Ø4	Ø6	Ø8	Ø4	Ø6	Ø8
5/2	200	440	620	200	480	800
5/3	200	440	580	200	460	720
3/2+3/2	200	440	600	200	460	720

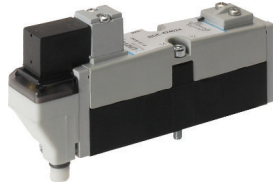
BD 26 mm	VDMA-ISO				Oversized			
	Ø6	Ø8	Ø10	Ø12	Ø6	Ø8	Ø10	Ø12
5/2	500	950	1200	1250	500	1050	1500	1700
5/3	500	900	1100	1150	500	1050	1300	1400
3/2+3/2	500	950	1150	1250	500	1050	1450	1650

BDE Electrical impulse - Solenoid valve with integrated electrical connection

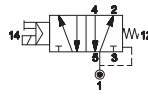
■ Single impulse



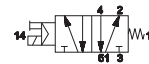
18 mm



26 mm

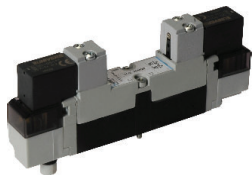


BDE-324024 18 mm
BDE-424024 26 mm

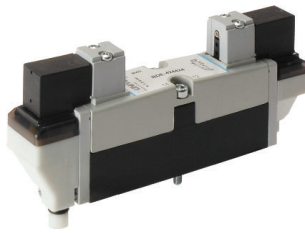


BDE-324124 18 mm
BDE-424124 26 mm

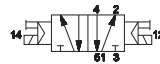
■ Double impulse



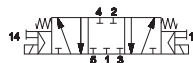
18 mm



26 mm



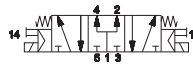
BDE-324424 18 mm
BDE-424424 26 mm



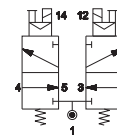
BDE-334424 18 mm
BDE-434424 26 mm



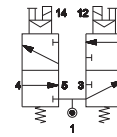
BDE-344424 18 mm
BDE-444424 26 mm



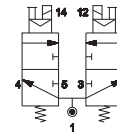
BDE-354424 18 mm
BDE-454424 26 mm



BDE-364424 18 mm
BDE-464424 26 mm



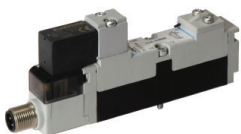
BDE-374424 18 mm
BDE-474424 26 mm



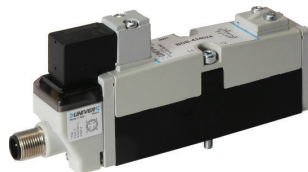
BDE-384424 18 mm
BDE-484424 26 mm

BDB Electrical impulse - Solenoid valve with connector M12

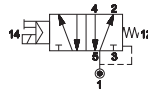
■ Single impulse



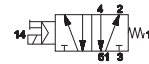
18 mm



26 mm

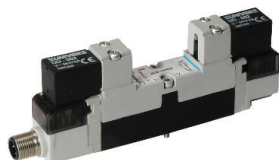


BDB-324024 18 mm
BDB-424024 26 mm

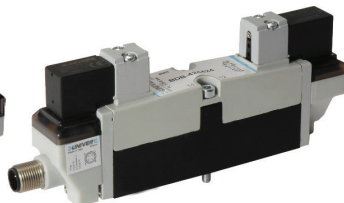


BDB-324124 18 mm
BDB-424124 26 mm

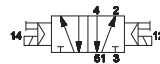
■ Double impulse



18 mm



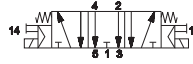
26 mm



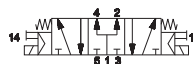
BDB-324424 18 mm
BDB-424424 26 mm



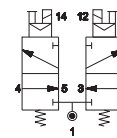
BDB-334424 18 mm
BDB-434424 26 mm



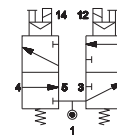
BDB-344424 18 mm
BDB-444424 26 mm



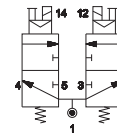
BDB-354424 18 mm
BDB-454424 26 mm



BDB-364424 18 mm
BDB-464424 26 mm



BDB-374424 18 mm
BDB-474424 26 mm



BDB-384424 18 mm
BDB-484424 26 mm

BDA Pneumatic impulse

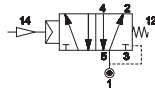
■ Single/double impulse



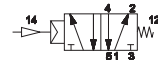
18 mm



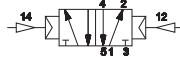
26 mm



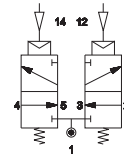
BDA-3230 18 mm
BDA-4230 26 mm



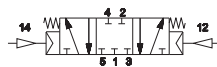
BDA-3231 18 mm
BDA-4231 26 mm



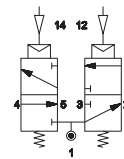
BDA-3233 18 mm
BDA-4233 26 mm



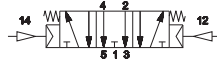
BDA-3633 18 mm
BDA-4633 26 mm



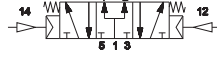
BDA-3333 18 mm
BDA-4333 26 mm



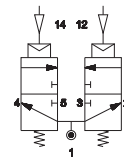
BDA-3733 18 mm
BDA-4733 26 mm



BDA-3433 18 mm
BDA-4433 26 mm



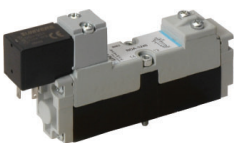
BDA-3533 18 mm
BDA-4533 26 mm



BDA-3833 18 mm
BDA-4833 26 mm

BDA Electrical impulse - External electrical connection

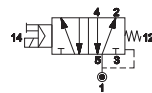
■ Single impulse



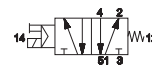
18 mm



26 mm

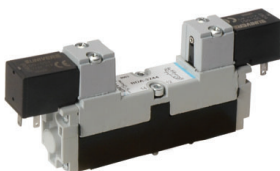


BDA-3240 18 mm
BDA-4240 26 mm

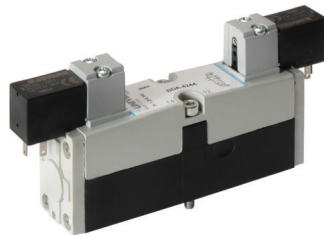


BDA-3241 18 mm
BDA-4241 26 mm

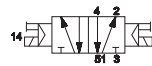
■ Double impulse



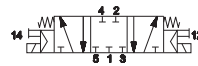
18 mm



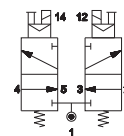
26 mm



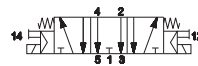
BDA-3244 18 mm
BDA-4244 26 mm



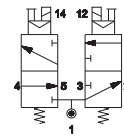
BDA-3344 18 mm
BDA-4344 26 mm



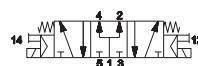
BDA-3644 18 mm
BDA-4644 26 mm



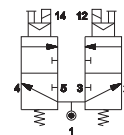
BDA-3444 18 mm
BDA-4444 26 mm



BDA-3744 18 mm
BDA-4744 26 mm



BDA-3544 18 mm
BDA-4544 26 mm



BDA-3844 18 mm
BDA-4844 26 mm



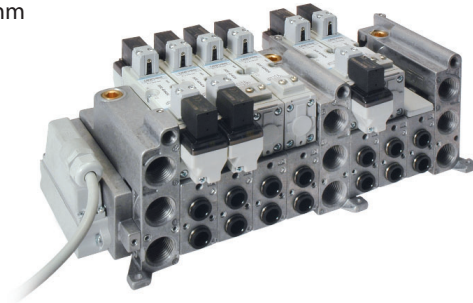
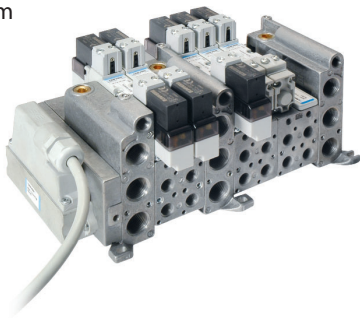
DIN C (8 mm)

For further information please contact our Sales Office.

BDE Manifold sub-bases - Integrated electrical connection

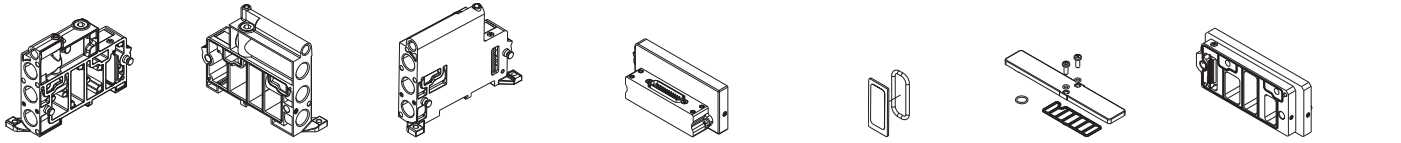
■ 18 mm

■ 26 mm



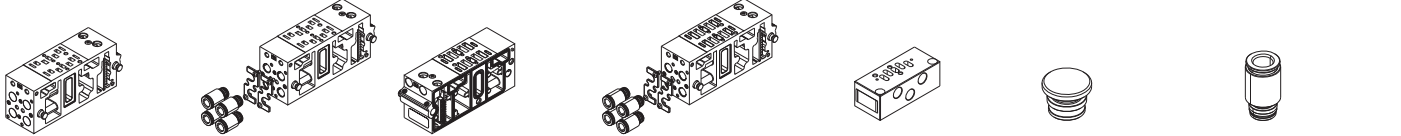
18 mm

BDF-3100 **BDF-3115** **BDF-3120** **BDF-3140TIM** **BDF-3180** **BDF-3185** **BDF-3190**



left supply plate G3/8 right supply plate G3/8 intermediate supply plate G3/8 multipolar male connection module: 25 poles, type D pressure separator closing plate for unused valve place connecting interface for valves side 18-26 mm

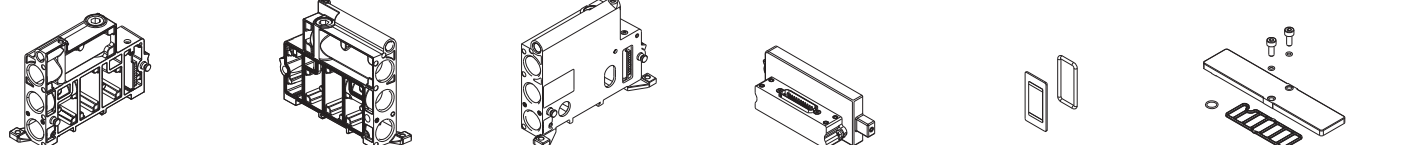
BDF-3210 **BDF-3230 (a)** **BDF-3310** **BDF-3330 (a)** **BDF-3400** **GZR-100** **GZR-V10004/06/08**



two-place sub-base in compliance with VDMA-ISO flow rate 620 NI/min G1/8 connections two-place sub-base in compliance with VDMA-ISO flow rate 620 NI/min fittings Ø 4-6-8 mm two-place sub-base with increased flow rate 800 NI/min G1/8 connections two-place sub-base with increased flow rate 800 NI/min fittings Ø 4-6-8 mm single one-place sub-base with increased flow rate blanking plug UNIVER designed fittings GZR-V10004 Ø4 mm, GZR-V10006 Ø6 mm, GZR-V10008 Ø8 mm

26 mm

BDF-4100 **BDF-4115** **BDF-4120** **BDF-4140TIM** **BDF-4180** **BDF-4185**



left supply plate G1/2 right supply plate G1/2 intermediate supply plate G1/2 multipolar male connection module: 25 poles, type D plate for separating supply pressures closing plate for unused valve place

BDF-4210/20 **BDF-4230 (a)** **BDF-4310/20** **BDF-4330 (a)** **BDF-4400** **GZR-VV1006/08/10**



one-place sub-base in compliance with VDMA-ISO flow rate 1250 NI/min BDF-4210 G1/4 connections, BDF-4220 G3/8 connections one-place sub-base in compliance with VDMA-ISO flow rate 1250 NI/min fittings Ø 6-8-10 mm one-place sub-base with increased flow rate 1700 NI/min BDF-4310 G1/4 connections, BDF-4320 G3/8 connections one-place sub-base with increased flow rate 1700 NI/min fittings Ø 6-8-10 mm single one-place sub-base with increased flow rate UNIVER designed fittings GZR-VV1006 Ø6 mm, GZR-VV1008 Ø8 mm, GZR-VV1010 Ø10 mm

Electrical connections

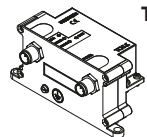
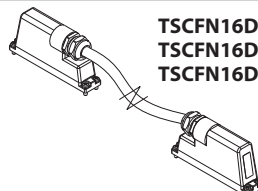
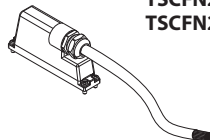
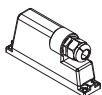
IO-LINK connection

TSCFN24S000

TSCFN24S0300
TSCFN24S0500
TSCFN24S1000

TSCFN16D0300
TSCFN16D0500
TSCFN16D1000

TCXLKA
TCXLKB



female connector 25 poles sub-D type no cable - M3x8 fixing screws

female connector: 25 poles, sub-D type, prewired for 26 coils (3-5-10m length) M3x8 fixing screws

sub-D type male/female flying connector (upon request) prewired for 16 coils with cable Ø 8 mm (3-5-10 m length) suitable for dynamic laying - M3 x 8 fixing screws

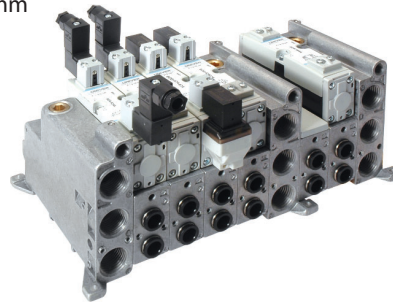
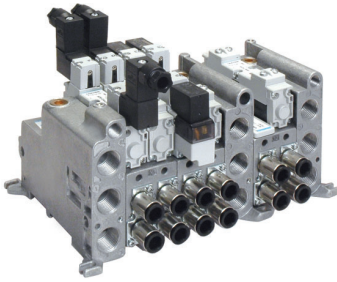
connection module IO-LINK (port class A/B)

(a) = Sub-base including fixing plate for fittings (fittings excluded)

BDA/BDB Manifold sub-bases - Electrical connection with external connector

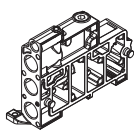
■ 18 mm

■ 26 mm

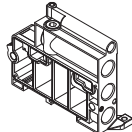


18 mm

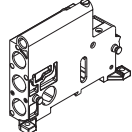
BDF-3110 **BDF-3115** **BDF-3125** **BDF-3180** **BDF-3185** **BDF-3191** **BDF-3400**



left supply plate G3/8



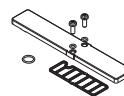
right supply plate G3/8



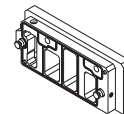
intermediate supply plate G3/8



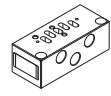
pressure separator



closing plate for unused valve place

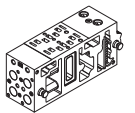


interface for connecting valves side 18-26 mm

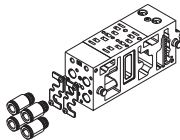


single one-place sub-base with increased flow rate G1/8

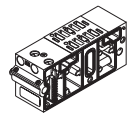
BDF-3211/2 (b) **BDF-3231/2 (a) - (b)** **BDF-3311/2 (b)** **BDF-3331/2 (a) - (b)** **GZR-100** **GZR-V10004/6/8** **DD-...**



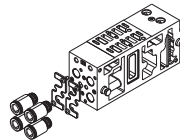
two-place sub-base in compliance with VDMA-ISO flow rate 620 NI/min G1/8 connections



two-place sub-base in compliance with VDMA-ISO flow rate 620 NI/min fittings Ø 4-6-8 mm



two-place sub-base with increased flow rate 800 NI/min G1/8 connections



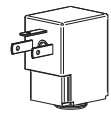
two-place sub-base with increased flow rate 800 NI/min fittings Ø 4-6-8 mm



blanking plug



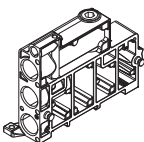
UNIVER designed fittings
GZR-V10004 Ø4 mm
GZR-V10006 Ø6 mm
GZR-V10008 Ø8 mm



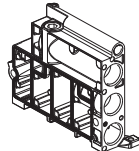
U05 coil side 15 mm

26 mm

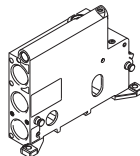
BDF-4110 **BDF-4115** **BDF-4125** **BDF-4180** **BDF-4185** **BDF-4400**



left supply plate G1/2



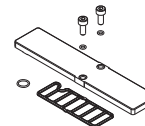
right supply plate G1/2



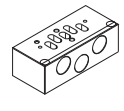
intermediate supply plate G1/2



pressure separator

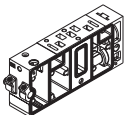


closing plate for unused valve place

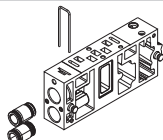


single one-place sub-base with increased flow rate G3/8

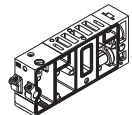
BDF-4211/.. (b) **BDF-4231/2 (a) - (b)** **BDF-4311/.. (b)** **BDF-4331/2 (a) - (b)** **GZR-VV1006/8/10** **DD-...**



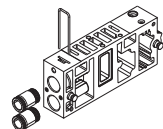
one-place sub-base in compliance with VDMA-ISO flow rate 1250 NI/min G1/4 connect. BDF-4211 BDF-4212



one-place sub-base in compliance with VDMA-ISO flow rate 1250 NI/min fittings Ø 6-8-10 mm BDF-4231 BDF-4232



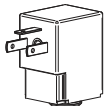
one-place sub-base with increased flow rate 1700 NI/min G1/4 connect. BDF-4311 BDF-4312



one-place sub-base with increased flow rate 1700 NI/min fittings Ø 6-8-10 mm BDF-4321 BDF-4322

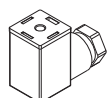


UNIVER designed fittings
GZR-VV1006 Ø6 mm
GZR-VV1008 Ø8 mm
GZR-VV1010 Ø10 mm



U05 coil side 15 mm

Electrical connections



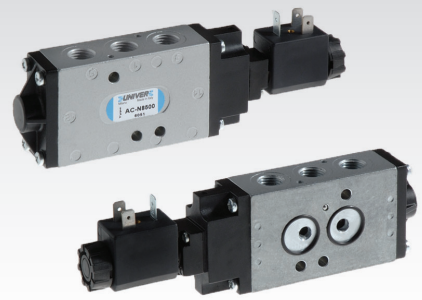
AM-5109

15 mm connector

(a) = Sub-base including fixing plate for fittings (fittings excluded)
(b) = Part No. ending: 1 = electrical non integrated 2 = only pneumatic

CHARACTERISTICS

Ambient temperature	-10 ÷ +45 °C
Fluid	50 µm filtered air, with or without lubrication
Commutation system	poppet mixed
Max pressure	10 bar
Connections	G1/4 (1-3-5), NAMUR interface (2-4)
Nominal bore (mm)	8
Nominal flow rate (NI/min)	1200
Valve body	zamak
Seals	NBR, polyurethane
Spool	aluminium
Electropilot/Coil	AA series/U1-U3
Power consumption	3,5 W (DC), 5 VA (AC)
Connector	AM-5110
Voltage	2 V DC - 24 V DC - 24 V AC - 110 V AC - 230 V AC
Manual override	impulse screw - 2 positions



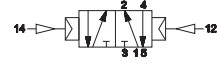
Pneumatic impulse

■ Single impulse



AC-N8100

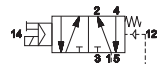
■ Double impulse



AC-N8120

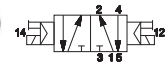
Electrical impulse

■ Single impulse



AC-N8500

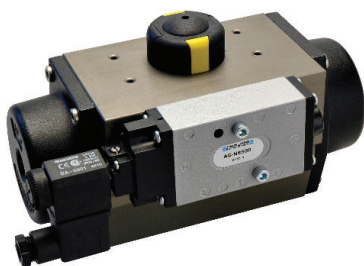
■ Double impulse



AC-N8520

Version 3/2: valves are supplied with proper flat plug for closing unused way
Solenoid valves are supplied without coil / connector / locking nut

■ AC-N8500 with YR2 actuator



See ATEX Catalogue for types and versions

CHARACTERISTICS

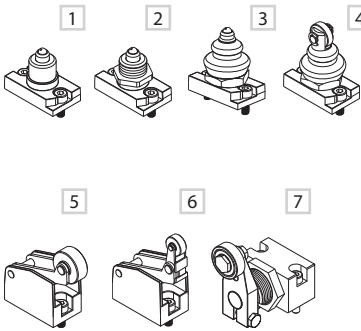
Ambient temperature	-10 ÷ +45 °C	
Fluid	50 µm filtered air, with or without lubrication	
Commutation system	spool	
Max pressure	10 bar	
Connections	G1/8	G1/4
Nominal bore (mm)	6,5	8,5
Nominal flow rate (NI/min)	890	1480
Valve body	die-cast zamak (G1/8), aluminium (G1/4)	
Seals	NBR	
Spool	aluminium	
Electropilot/Coil	AA series/U1-U3	
Power consumption	3,5 W (DC) - 5 VA (AC)	
Connector	AM-5110	
Voltage	12 V DC - 24 V DC - 24 V AC - 110 V AC - 230 V AC	
Manual override	impulse screw - 2 positions	



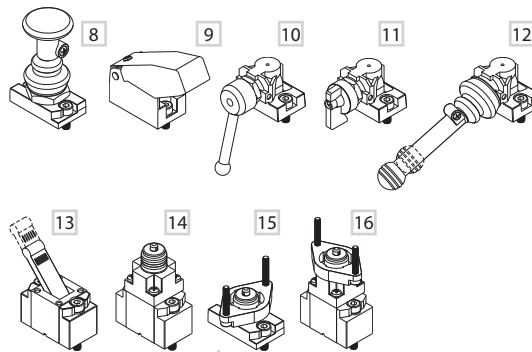
NOTE: some versions with high temperature seals are available upon request (for further information please contact our Sales Office)

UNIVERSAL Modular System

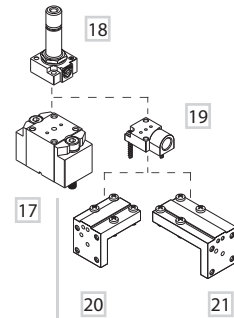
MECHANICAL



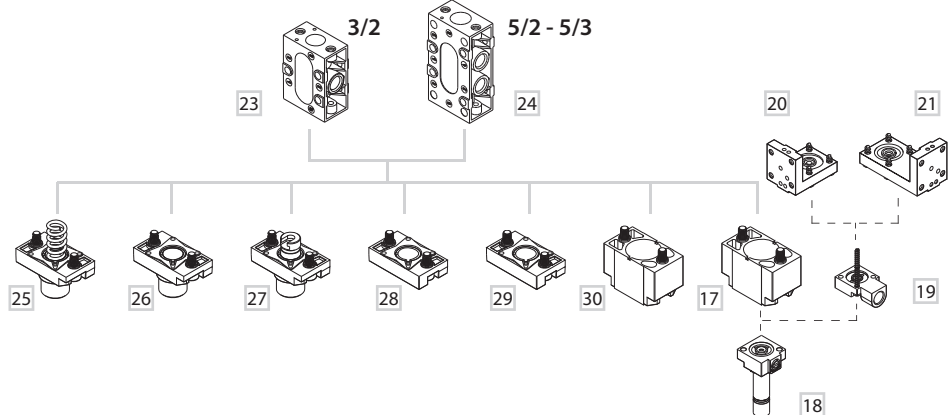
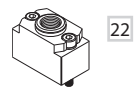
MANUAL



ELECTRICAL



PNEUMATIC



MECHANICAL CONTROL

- 1 Ball push
- 2 Ball push for screw panel mounting
- 3 Ball push with dust protection
- 4 Roller with dust protection
- 5 Roller lever
- 6 One-way roller lever
- 7 Two-way side roller lever

MANUAL CONTROL

- 8 Push-pull
- 9 Push button
- 10 Rotating lever
- 11 Selector

12 90° short/long lever

- 13 Short/long lever
- 14 Threaded indirect operation
- 15 Panel direct operation
- 16 Panel indirect operation

ELECTRICAL CONTROL

- 17 Electrical amplified
- 18 U1 electropilot
- 19 Plate for external pilot supply
- 20 Angle plate for "H" solenoid option
- 21 Angle plate for "P" solenoid option

PNEUMATIC CONTROL

- 22 Pneumatic amplified

BODY

- 23 3/2 body
- 24 5/2 body

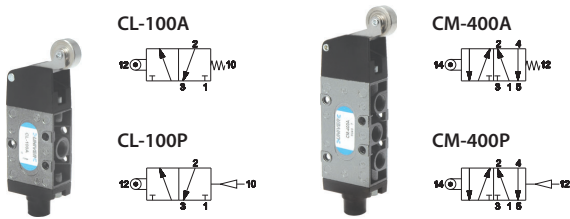
RETURN

- 25 Mechanical spring
- 26 Pneumatic not amplified
- 27 Bottom plate - 2/3 positions
- 28 Bottom plate
- 29 Pneumatic spring
- 30 Pneumatic amplified

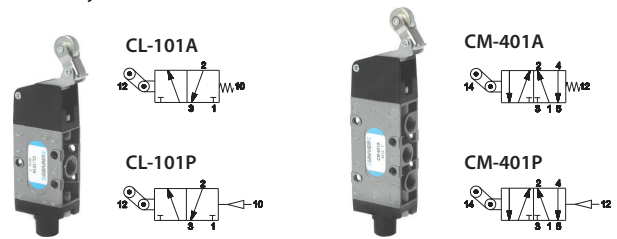
See ATEX Catalogue for types and versions

Valves G1/8 with direct mechanical operation

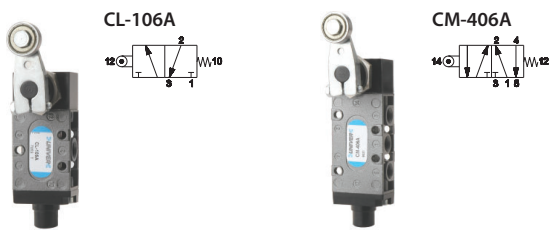
■ Roller lever



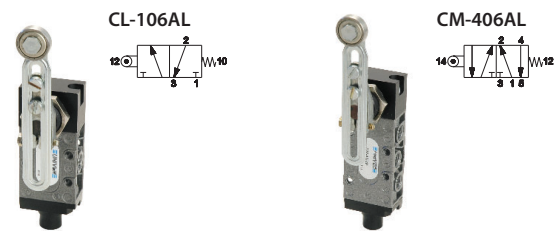
■ One-way roller lever



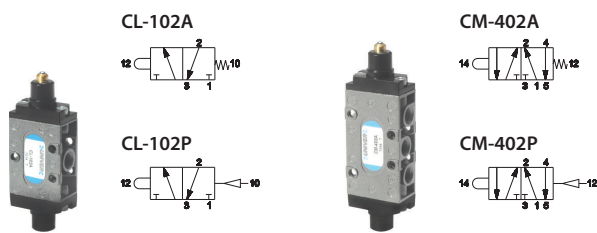
■ Two-way side roller lever



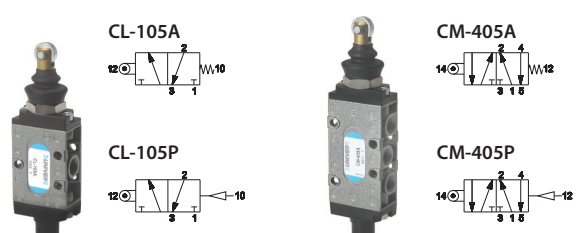
■ Adjustable two-way side roller lever



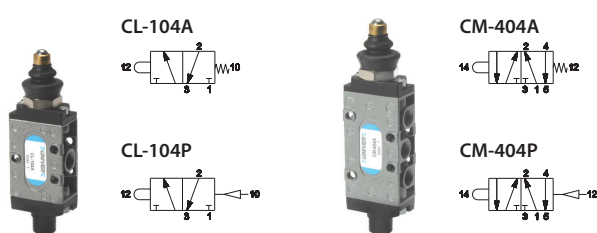
■ Ball-push



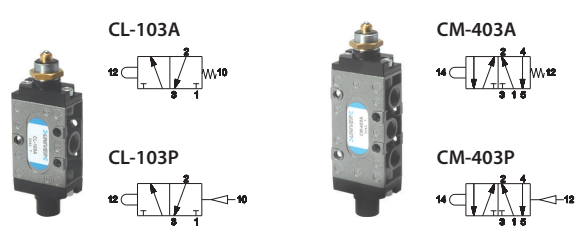
■ Roller with dust protection



■ Ball push with dust protection

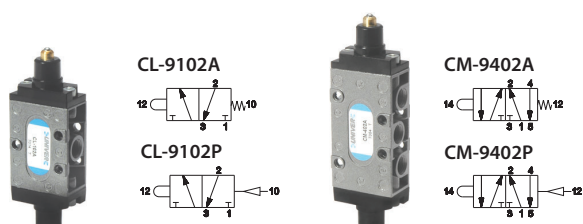


■ Ball push for screw panel mounting

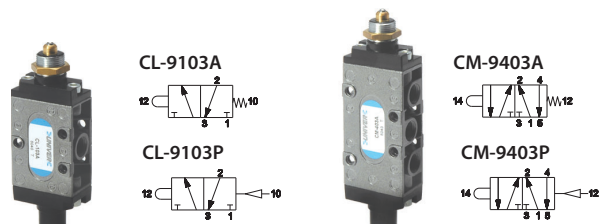


Valves G1/4 with direct mechanical operation

■ Ball push



■ Ball push for screw panel mounting



3

Valves G1/8 - G1/4 with indirect mechanical operation for pneumatic and mechanical operators

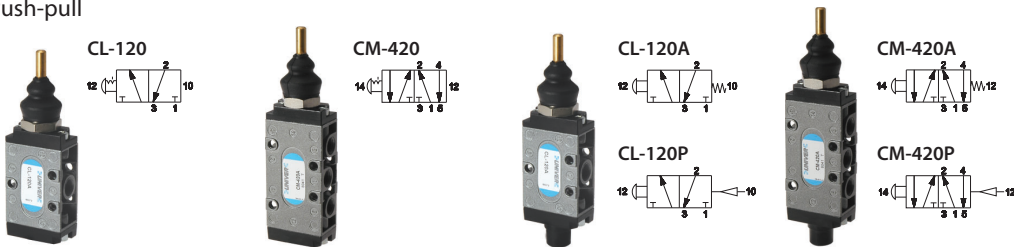
■ Ball push				■ Sensible ball push			
	CL-110A G 1/8 CL-9110A G 1/4		CM-410A G 1/8 CM-9410A G 1/4		CL-111A G 1/8 CL-9111A G 1/4		CM-411A G 1/8 CM-9411A G 1/4
	CL-110P G 1/8 CL-9110P G 1/4		CM-410P G 1/8 CM-9410P G 1/4		CL-111P G 1/8 CL-9111P G 1/4		CM-411P G 1/8 CM-9411P G 1/4
AI-3550	AI-3551	AI-3560	AI-3562	AI-3563	AI-3570	AI-3571	AI-3572
AI-3511	AI-3514	AI-3515	AI-3520	AI-3522 (2 pos.)	AI-3524	AI-3525	AI-3526
AI-3512	AI-3516	AI-3517	AI-3521	AI-3523			
AI-3513	AI-3514D	AI-3519					
	AI-3516D						

Valves G1/8 - G1/4 with direct and indirect operation for panel operators

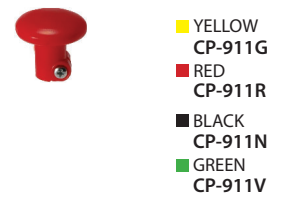
■ Ball push (direct operation)				■ Ball push (indirect operation)			
	CL-112A		CM-412A		CL-113A G 1/8 CL-9113A G 1/4		CM-413A G 1/8 CM-9413A G 1/4
	CL-112P		CM-412P		CL-113P G 1/8 CL-9113P G 1/4		CM-413P G 1/8 CM-9413P G 1/4
AI-3511Q	AI-3514Q	AI-3515Q	AI-3524Q	AI-3511Q	AI-3514Q	AI-3515Q	AI-3520Q
AI-3512Q	AI-3516Q	AI-3517Q		AI-3512Q	AI-3516Q	AI-3517Q	AI-3521Q
AI-3513Q	AI-3514QD	AI-3519Q		AI-3513Q	AI-3514QD	AI-3519Q	
	AI-3516QD				AI-3516QD		
				AI-3524Q	AI-3522Q (2 pos.)	AI-3525Q	AI-3526Q
					AI-3523Q		

Valves G1/8 with manual operation

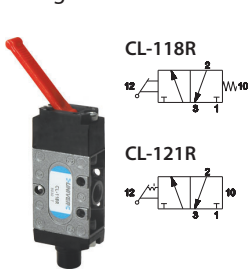
■ Push-pull



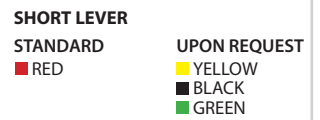
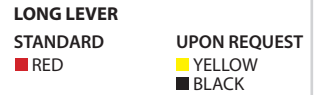
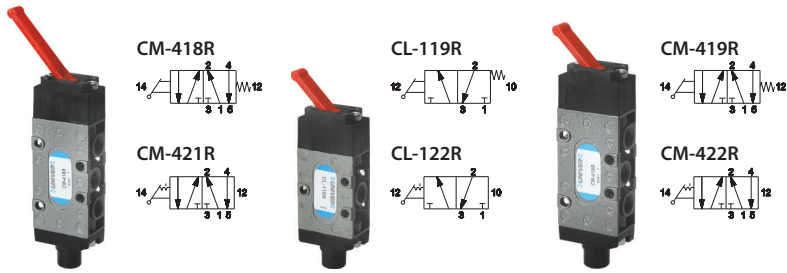
Valves are supplied without operator



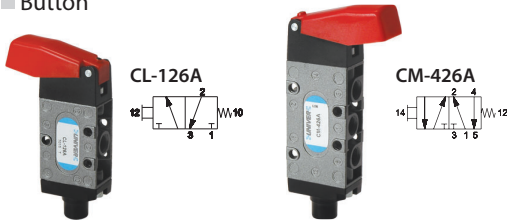
■ Long lever



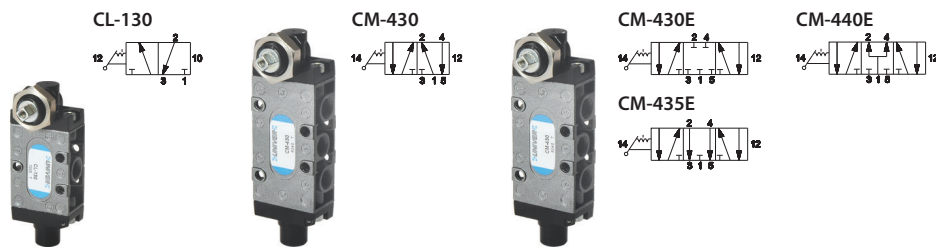
■ Short lever



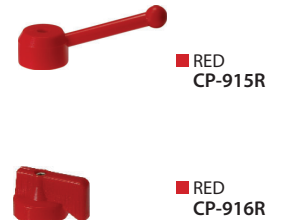
■ Button



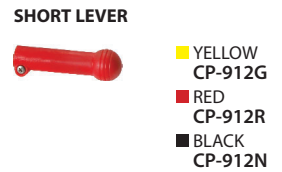
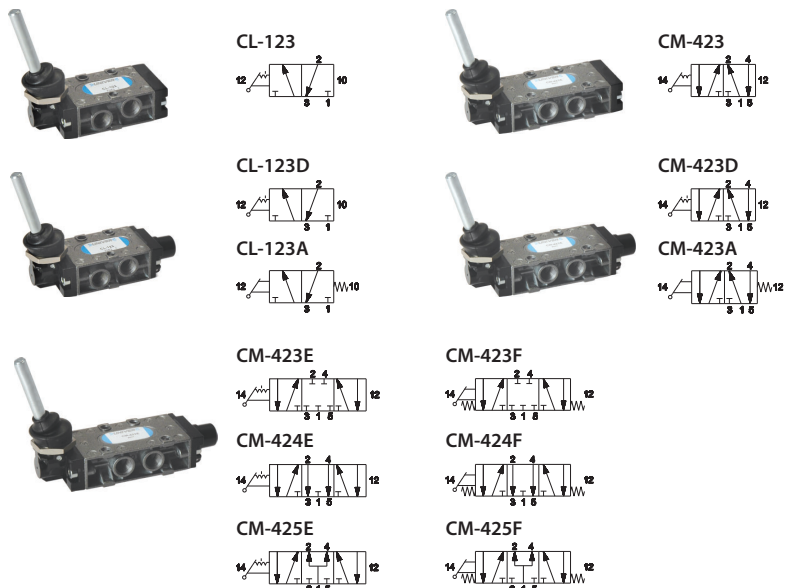
■ Rotating lever



Valves are supplied without operator



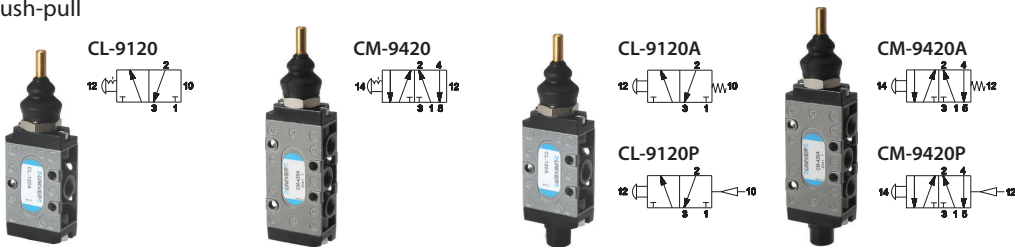
■ 90° Lever



Valves are supplied without operator

Valves G1/4 with manual operation

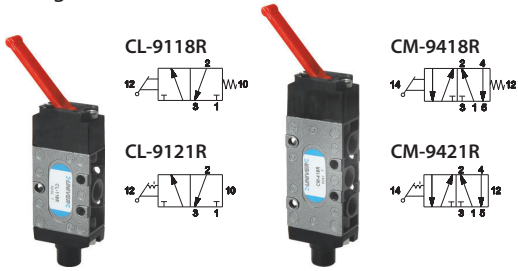
■ Push-pull



- YELLOW
CP-911G
- RED
CP-911R
- BLACK
CP-911N
- GREEN
CP-911V

Valves are supplied without operator

■ Long lever



- STANDARD
■ RED

- UPON REQUEST
■ YELLOW
■ BLACK

■ Rotating lever



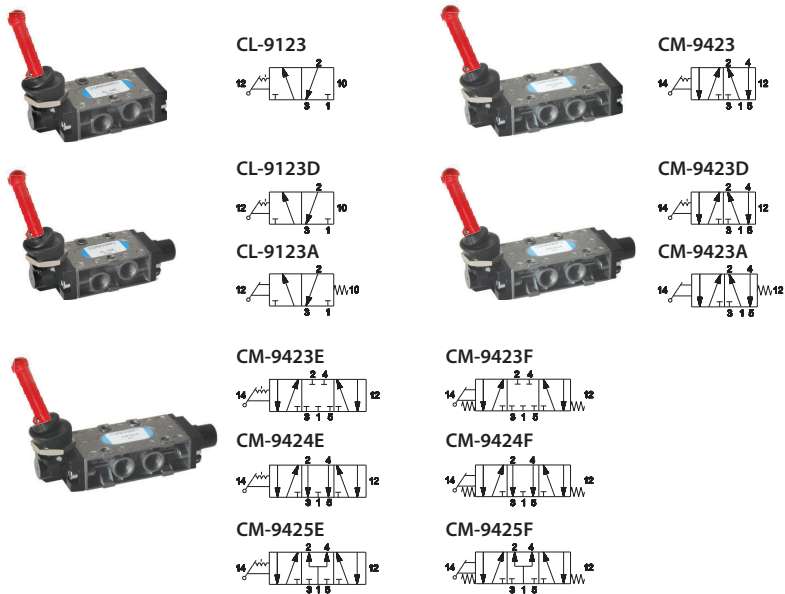
- RED
CP-915R



- RED
CP-916R

Valves are supplied without operator

■ 90° Lever



LONG LEVER



- RED
CP-913R

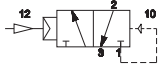
Valves are supplied with long lever operator

Valves G1/8 - G1/4 with pneumatic operation

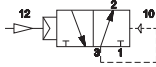
Single impulse



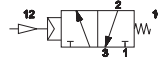
CL-200 G1/8
CL-9200 G1/4



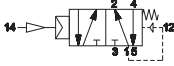
CL-203 G1/8 (NO)
CL-9203 G1/4 (NO)



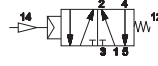
CL-200A G1/8
CL-9200A G1/4



CM-500 G1/8
CM-9500 G1/4



CM-500A G1/8
CM-9500A G1/4



Double impulse



CL-220 G1/8
CL-9220 G1/4



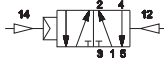
CL-221 G1/8
CL-9221 G1/4



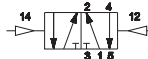
CL-224 G1/8
CL-9224 G1/4



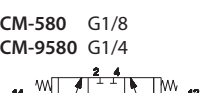
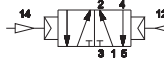
CM-521 G1/8
CM-9521 G1/4



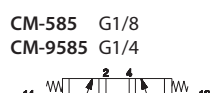
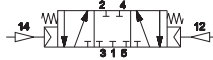
CM-524 G1/8
CM-9524 G1/4



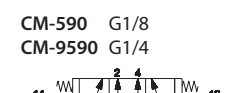
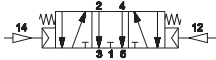
CM-520 G1/8
CM-9520 G1/4



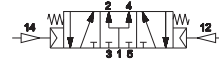
CM-580 G1/8
CM-9580 G1/4



CM-585 G1/8
CM-9585 G1/4



CM-590 G1/8
CM-9590 G1/4



Valves G1/8 - G1/4 with electrical operation

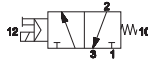
Single impulse



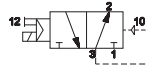
CL-300 G1/8
CL-9300 G1/4



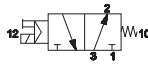
CL-302A G1/8
CL-9302A G1/4



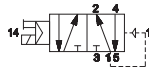
CL-301 G1/8
CL-9301 G1/4



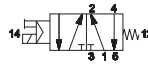
CL-303A G1/8 (NO)
CL-9303A G1/4 (NO)



CM-600 G1/8
CM-9600 G1/4



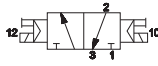
CM-602A G1/8
CM-9602A G1/4



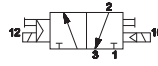
Double impulse



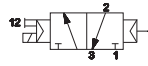
CL-320 G1/8
CL-9320 G1/4



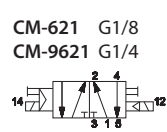
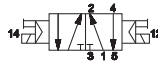
CL-321 G1/8
CL-9321 G1/4



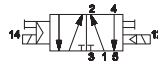
CL-322 G1/8
CL-9322 G1/4



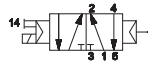
CM-620 G1/8
CM-9620 G1/4



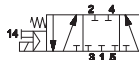
CM-621 G1/8
CM-9621 G1/4



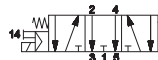
CM-622 G1/8
CM-9622 G1/4



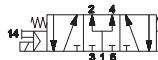
CM-680 G1/8
CM-9680 G1/4



CM-685 G1/8
CM-9685 G1/4



CM-690 G1/8
CM-9690 G1/4



Solenoid valves are supplied without coil, connector and locking nut

AM-5148

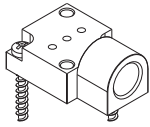
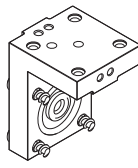


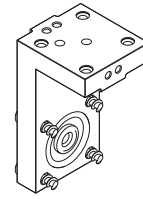
Plate for external pilot supply

AM-5151



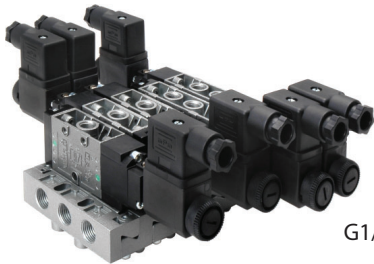
Angle plate for "H" solenoid option

AM-5152

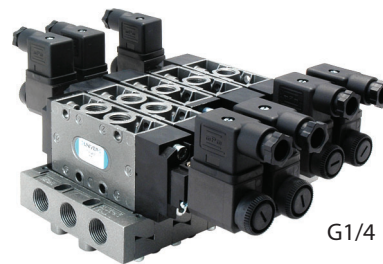


Angle plate for "P" solenoid option

CLIPS Modular sub-base G1/8 - G1/4 for 3/2 - 5/2 - 5/3 valves

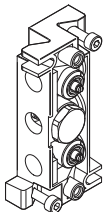


G1/8



G1/4

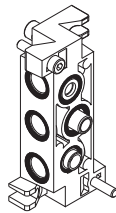
CP-100/CP-9100



modular sub-base with adjustable and conveyed exhausts
CP-100 for G1/8, **CP-9100** for G1/4
 material: zamak

standard supplied: screws, seals, exhaust regulator and coupling for valve fixing

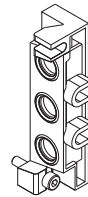
CP-101/CP-9101



modular sub-base without adjustable exhausts
CP-101 for G1/8, **CP-9101** for G1/4
 material: zamak

standard supplied: screws, seals and coupling for valve fixing

CP-105/CP-9105



side connection inlet plate
CP-105 G1/4, **CP-9105** G3/8
 material: zamak

standard supplied: screws and seals

CP-106



closing plate for unused place bases G1/8
 material: aluminium

CP-110/CP-9110



coupling
 connections: **CP-110** G1/8, **CP-9110** G1/4
 material: brass

CP-111/CP-9111



pressure separator
CP-111 for G1/8, **CP-9111** for G1/4
 material: aluminium

CP-112/CP-9112



plug for 3/2 valve mounting
CP-112 for G1/8, **CP-9112** for G1/4
 material: aluminium

CP-113/CP-9113

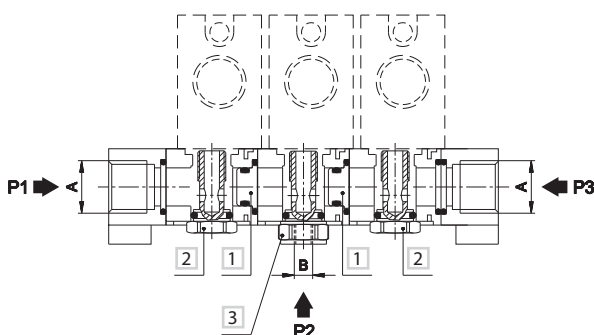


adjustment needle
CP-113 for G1/8, **CP-9113** for G1/4
 material: brass

For each additional pressure, one coupling and two separators are required

Plug for mounting 3/2 NC-NO valves on "CLIPS" sub-base to close unused way. Sub-base with adjustment screw (screwdriver slot) standard supplied. Upon request: adjustment needle with milled handle

■ Assembly Example
 Manifold supplied by three different pressures



	A	B
G1/8	G1/4	G1/8
G1/4	G3/8	G1/4

- 1 Pressure separator CP-111/CP-9111
- 2 Fixing coupling for valve embodied in the sub-base
- 3 Coupling CP-110/CP-9110

CHARACTERISTICS

Ambient temperature	-10 ÷ +45 °C
Fluid	10 µm filtered air
Commutation system	spool
Max pressure	10 bar
Connections	M5, for sub-base
Nominal bore (mm)	2
Nominal flow rate (NI/min)	150
Valve body	zamak
Seals	NBR
Electropilot/Coil	A series/U05
Voltage	24 V DC - 12 V DC - 24 V AC - 110 V AC - 230 V AC



CODIFICATION KEY

E	-	0	2	2	4	
1		2	3	4	5	

1 Series	2 Type	3 Control 14	4 Return 12
E = COMPA 2 Miniature Valves	02 = 5/2 Sub-base mounting 04 = 5/2 Threaded body M5 05 = 5/3 c.c. Sub-base mounting 06 = 5/3 o.c. Sub-base mounting 07 = 5/3 p.c. Sub-base mounting 08 = 5/3 c.c. Threaded body M5 09 = 5/3 o.c. Threaded body M5 10 = 5/3 p.c. Threaded body M5	2 = Electrical DC 4 = Pneumatic 7 = Electrical DC/AC	0 = Pneumomechanical spring 2 = Electrical DC 4 = Pneumatic impulse 7 = Electrical DC/AC

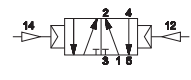
5 ATEX option

X = Atex (upon request)

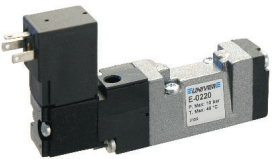
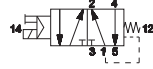
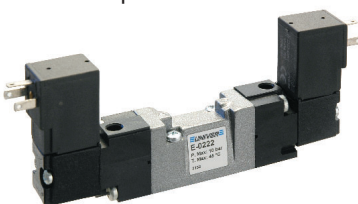
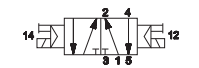
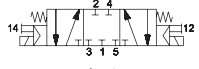
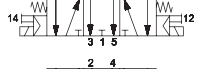
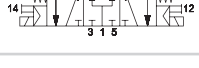
See ATEX Catalogue for types and versions

c.c. = closed centres o.c. = open centres p.c. = pressurized centres

Pneumatic impulse

<p>■ Single impulse</p>   <p>E-0240</p>	<p>■ Double impulse</p>   <p>E-0244</p>
---	---

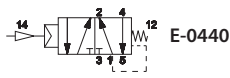
Electrical impulse

<p>■ Single impulse</p>   <p>E-0220 E-0270</p>	<p>■ Double impulse</p>   <p>E-0222 E-0277</p>  <p>E-0522</p>  <p>E-0622</p>  <p>E-0722</p>
--	---

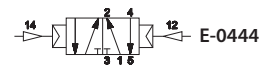
Solenoid valves are supplied without coil and connector

Pneumatic impulse - 5/2 Valves M5

■ Single impulse

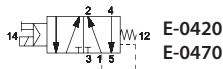
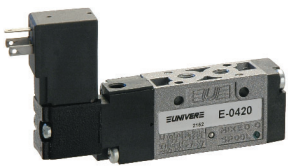


■ Double impulse

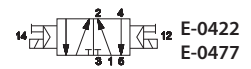
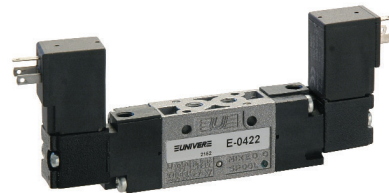


Electrical impulse - 5/2 Valves M5

■ Single impulse

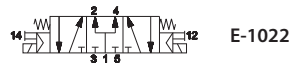
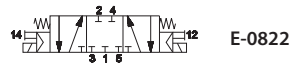
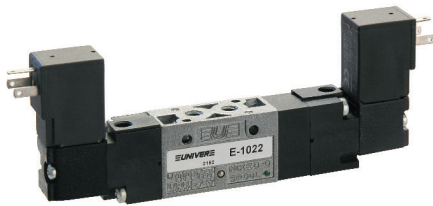


■ Double impulse



Electrical impulse - 5/3 Valves M5

■ Double impulse



Inlet plate G1/8

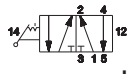
Manifold sub-base, side connections M5



5/2 Valves M5 - Mechanical and manual operation

3

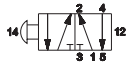
■ Lever valve



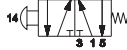
LEVER

- E-15422G ■ YELLOW
- E-15422N ■ BLACK
- E-15422R ■ RED

■ Push-pull valve

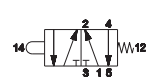


E-15420



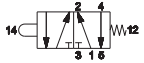
E-15420A

■ Ball push valve



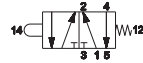
E-15402A

■ Ball push valve for mechanical screw operation



E-15403A

■ Ball push valve for mechanical panel operation

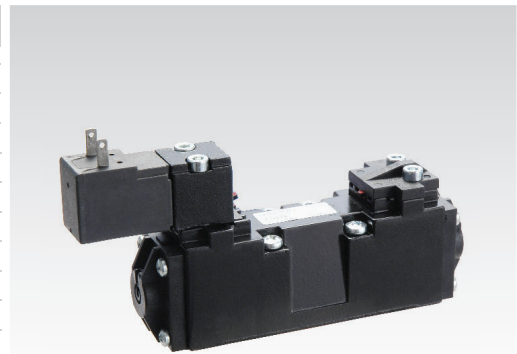


E-15412A

AI-3550	AI-3551	AI-3560	AI-3562	AI-3563	AI-3570	AI-3571	AI-3572	AI-3511Q ■	AI-3514Q ■	AI-3515Q ■	AI-3520Q ■	AI-3524Q ■	AI-3522Q ■	AI-3525Q ■	AI-3526Q ■
								AI-3512Q ■	AI-3516Q ■	AI-3517Q ■	AI-3521Q ■				
								AI-3513Q ■	AI-3514QD ■	AI-3519Q ■					
								AI-3516QD ■							
AI-3511 ■	AI-3514 ■	AI-3515 ■	AI-3520 ■	AI-3522 ■	AI-3524 ■	AI-3525 ■	AI-3526 ■								
AI-3512 ■	AI-3516 ■	AI-3517 ■	AI-3521 ■	AI-3522 (2 pos.)											
AI-3513 ■	AI-3514D ■	AI-3519 ■		AI-3523 ■											
	AI-3516D ■														

CHARACTERISTICS

Ambient temperature	-10 ÷ +45 °C
Fluid	10 µm filtered air
Commutation system	spool
Max pressure	10 bar
Connections	for sub-base
Nominal bore (mm)	4
Nominal flow rate (NI/min)	390
Valve body	acetalic resin
Seals	NBR
Electropilot/Coil	A series/U05
Voltage	24 V DC - 12 V DC - 24 V AC - 110 V AC - 230 V AC




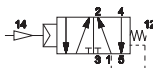

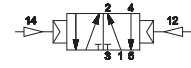
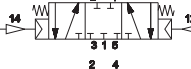
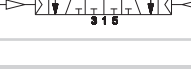
CODIFICATION KEY

F	-	0	2	2	4	
1		2	3	4	5	

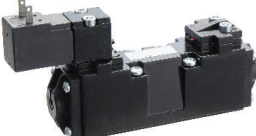
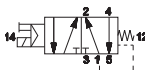
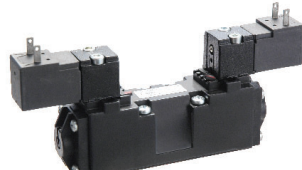
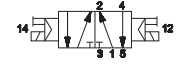
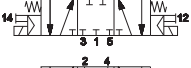
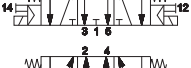
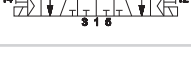
1 Series	2 Type	3 Control 14	4 Return 12	5 ATEX option
F = COMPA 4 Miniature Valves	02 = 5/2 Sub-base mounting 05 = 5/3 c.c. Sub-base mounting 06 = 5/3 o.c. Sub-base mounting 07 = 5/3 p.c. Sub-base mounting	2 = Electrical DC 4 = Pneumatic 7 = Electrical DC/AC	0 = Pneumomechanical spring 2 = Electrical DC 4 = Pneumatic impulse 7 = Electrical DC/AC	X = ATEX (upon request) See ATEX Catalogue for types and versions

c.c. = closed centres o.c. = open centres p.c. = pressurized centres

Pneumatic impulse


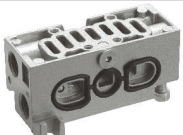
<p>■ Single impulse</p> 	 <p>F-0240</p>	<p>■ Double impulse</p> 	 <p>F-0244</p>  <p>F-0544</p>  <p>F-0644</p>  <p>F-0744</p>
---	---	---	---

Electrical impulse

<p>■ Single impulse</p> 	 <p>F-0220 F-0270</p>	<p>■ Double impulse</p> 	 <p>F-0222 F-0277</p>  <p>F-0522 F-0577</p>  <p>F-0622 F-0677</p>  <p>F-0722 F-0777</p>
---	--	--	---

Inlet plate G1/8

Manifold sub-base, threaded connections G1/8

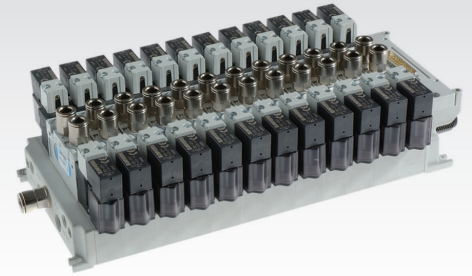
 <p>F-4500</p>	 <p>F-4505</p>
---	---

Solenoid valves are supplied without coil and connector

3

CHARACTERISTICS

Ambient temperature	-5 ÷ +50 °C
Fluid	50 µm filtered air, with or without lubrication
Commutation system	spool
Pressure	1,5 ÷ 9 bar
Nominal bore (mm)	5
Nominal flow rate (NI/min)	770 (5/2) 700 (5/3) 670 (3/2+3/2)
Connections	G1/8
Valve body	zamak
Seals	NBR
Spool	aluminium
Electropilot/Coil	A series/U05 - B series/U04
Voltage	24 V DC - 12 V DC - 24 V AC - 110 V AC - 230 V AC (only for version with integrated electrical connection)
Power consumption	U05 = 2 W (DC) 2,3 VA (AC) U04 = 1,2 W (DC)
Manual override	recessed button - 1 position



CODIFICATION KEY

G	-	6	6	4	4		
1	2	3	4	5	6		

1 Series G-6 = 20 mm - Valves and solenoid valves threaded body G1/8	2 Type 2 = 5/2 6 = 3/2+3/2 NC-NC 3 = 5/3 c.c. 7 = 3/2+3/2 NC-NO 4 = 5/3 o.c. 8 = 3/2+3/2 NO-NO 5 = 5/3 p.c.	3 Control 14 3 = Pneumatic amplified 4 = Electrical amplified DC 5 = Electrical amplified DC/AC 6 = Electrical amplified DC - B series 10 mm electropilot
4 Return 12 0 = Pneumomechanical spring 1 = Mechanical spring 3 = Pneumatic amplified 4 = Electrical amplified DC 5 = Electrical amplified DC/AC 6 = Electrical amplified DC (B series 10 mm electropilot)	5 Option D = External pilot supply	6 ATEX option X = Atex (upon request) See ATEX Catalogue for types and versions

c.c. = closed centres o.c. = open centres p.c. = pressurized centres

Pneumatic impulse

■ Single impulse

G-6230

G-6231

■ Double impulse

G-6233

G-6333

G-6433

G-6533

G-6633

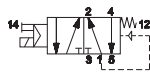
G-6733

G-6833

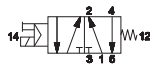
Solenoid valves are supplied without coil and connector

Electrical impulse - A series 15 mm Electropilot

■ Single impulse



G-6240 DC
G-6250 AC/DC



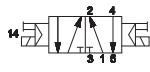
G-6241 DC
G-6251 AC/DC



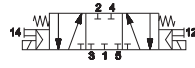
Coil with intergrated connector for multipolar version
DD-051-2C 24 V DC
DD-040-2C 24 V AC

Single/double impulse

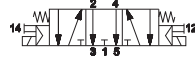
■ Double impulse



G-6244 DC
G-6255 AC/DC



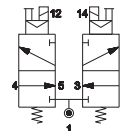
G-6344 DC
G-6355 AC/DC



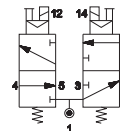
G-6444 DC
G-6455 AC/DC



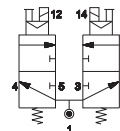
G-6544 DC
G-6555 AC/DC



G-6644 DC
G-6655 AC/DC



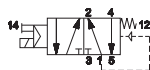
G-6744 DC
G-6755 AC/DC



G-6844 DC
G-6855 AC/DC

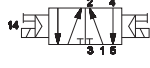
Electrical impulse - B series 10 mm Electropilot

■ Single impulse

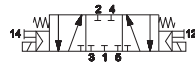


G-6260
G-6261

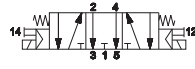
■ Double impulse



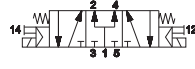
G-6266



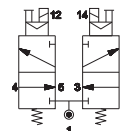
G-6366



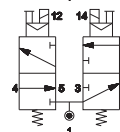
G-6466



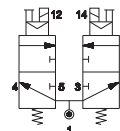
G-6566



G-6666



G-6766



G-6866

Solenoid valves are supplied without coil and connector

Electrical sub-base

■ Multipolar connection

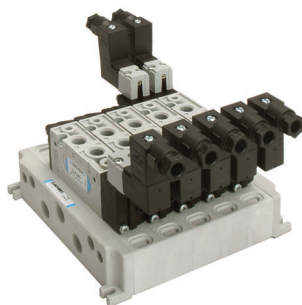
■ External connection

■ Connector with loose cables

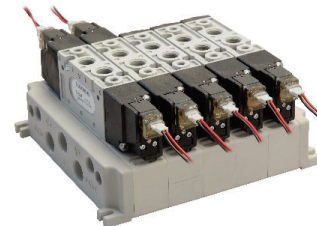
3



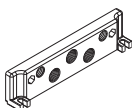
GP-6100



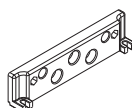
GP-611806



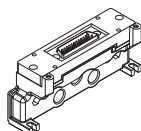
GP-6320/1/2



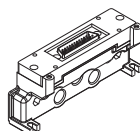
threaded end plate



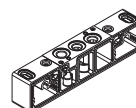
blank end plate



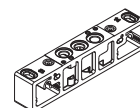
threaded end plate with male connector
25 poles
12+12 coils control 12-14



threaded end plate with male connector
25 poles
18 coils control 14
6 coils control 12



sub-base with open diaphragms
GP-6310 without electrical connection
GP-6311 monostable
GP-6312 bistable



sub-base with closed diaphragms
GP-6320 without electrical connection
GP-6321 monostable
GP-6322 bistable

GP-6330/1/2

GP-6340/1/2

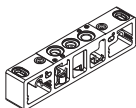
GP-6380

GP-6385

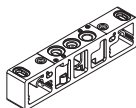
GP-6400-1

GP-6400-2

GP-6400-5



sub-base with closed air supply and open exhausts
GP-6330 without electrical connection
GP-6331 mostable
GP-6332 bistable



sub-base with open air supply and closed exhausts
GP-6340 without electrical connection
GP-6341 mostable
GP-6342 bistable



intermediate supply plate (to be used only with GP-63... sub-base)



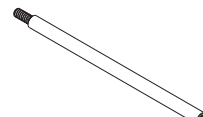
closing plate for unused valve place



modular tie-rod
1 valve place



modular tie-rod
2 valve places



modular tie-rod
5 valve places

AZ4-SN004A

No. 100 hexagonal nuts M4

AZ4-VN0416

No. 100 allen screws M4x16 for tie rods

GP-6512-01/..MF

GP-6514-01/..MF

GP-651418

DD-...

DD-051-2C/DD-040-2C

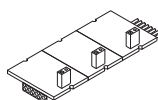
DE-6521



BUS connection card control side 12 with 12 pins
GP-6512-01MF 1 place
GP-6512-02MF 2 places
GP-6512-03MF 3 places
GP-6512-05MF 5 places
GP-6512-06MF 6 places



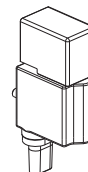
BUS connection card control side 14 with 12 pins
GP-6514-01MF 1 place
GP-6514-02MF 2 places
GP-6514-03MF 3 places
GP-6514-05MF 5 places
GP-6514-06MF 6 places



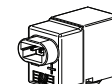
BUS connection card control side 14 with 18 pins (only 12 places) for manifolds with control 14 and more than 12 coils (up to 18) use GP-651418 card 12 places and then GP-6514-...



24 V DC 2 W coil for single connection



24 V DC 2 W coil with integrated connector for multipolar version

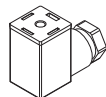


24 V DC 1,35 W coil with in-line connector with protection for a complete tightness

D-530-30/50/200

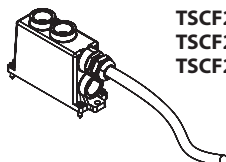
Customized solutions up to 12 places available upon request

Electrical connections



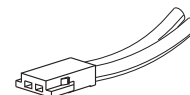
AM-5109

15 mm connector



TSCF24S0300
TSCF24S0500
TSCF24S1000

sub-D flying female connector in compliance with CEI 20-22 O.R. II prewired for 24 coils (3-5-10 length) M3x12 fixing screws



Miniature connector with loose cables

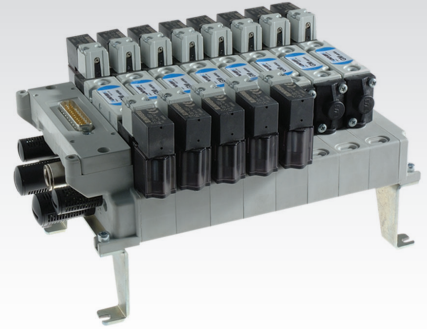
D-530-30 = wire length 300 mm

D-530-50 = wire length 500 mm

D-530-200 = wire length 2000 mm

CHARACTERISTICS

Ambient temperature	-5 ÷ +50 °C
Fluid	50 µm filtered air, with or without lubrication
Commutation system	spool
Pressure	1,5 ÷ 9 bar
Connections	sub-base interface
Nominal bore (mm)	5
Nominal flow rate (NI/min)	140 ÷ 740 (depending on the type of fittings)
Valve body	zamak
Seals	NBR
Spool	aluminium
Electropilot/Coil	A series/U05 - B series/U04
Voltage	24 V DC - 12 V DC - 24 V AC - 110 V AC - 230 V AC (only version with external connection)
Power consumption	U05 = 2 W (DC) 2,3 VA (AC) U04 = 1,2 W (DC)
Manual override	recessed button - 1 position


CODIFICATION KEY


G	L	-	6	6	4	4		
1	2	3	4	5	6			

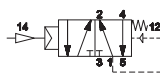
1 Series	2 Type	3 Control 14	4 Return 12
GL-6 = 20 mm - Valves and Solenoid Valves for sub-base mounting	2 = 5/2 3 = 5/3 c.c. 4 = 5/3 o.c. 5 = 5/3 p.c. 6 = 3/2+3/2 NC-NC 7 = 3/2+3/2 NC-NO 8 = 3/2+3/2 NO-NO	3 = Pneumatic amplified 4 = Electrical amplified DC 5 = Electrical amplified DC/AC 6 = Electrical amplified DC B series 10 mm electropilot	0 = Pneumomechanical spring 1 = Mechanical spring 3 = Pneumatic amplified 4 = Electrical amplified DC 5 = Electrical amplified DC/AC 6 = Electrical amplified DC B series 10 mm electropilot
5 Option	6 ATEX option		
D = External pilot supply	X = Atex (upon request) See ATEX Catalogue for types and versions		

c.c. = closed centres o.c. = open centres p.c. = pressurized centres

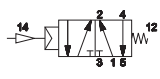
Pneumatic impulse

■ Single impulse






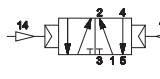
GL-6230



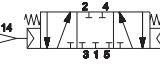
GL-6231

■ Double impulse

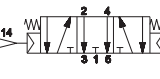




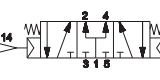
GL-6233



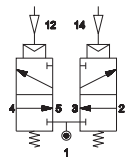
GL-6333



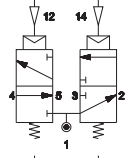
GL-6433



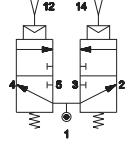
GL-6533



GL-6633



GL-6733

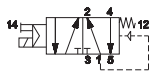


GL-6833

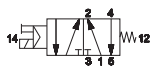
Solenoid valves are supplied without coil and connector

Electrical impulse - A series 15 mm Electropilot

Single impulse



GL-6240 DC
GL-6250 AC/DC



GL-6241 DC
GL-6251 AC/DC



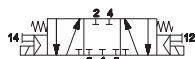
Coil with integrated connector for multipolar version
DD-051-2C 24 V DC
DD-040-2C 24 V AC

Single/double impulse

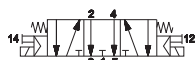
Double impulse



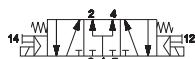
GL-6244 DC
GL-6255 AC/DC



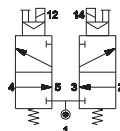
GL-6344 DC
GL-6355 AC/DC



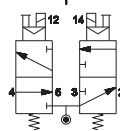
GL-6444 DC
GL-6455 AC/DC



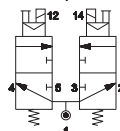
GL-6544 DC
GL-6555 AC/DC



GL-6644 DC
GL-6655 AC/DC



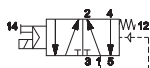
GL-6744 DC
GL-6755 AC/DC



GL-6844 DC
GL-6855 AC/DC

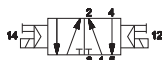
Electrical impulse - B series 10 mm Electropilot

Single impulse

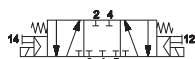


GL-6260
GL-6261

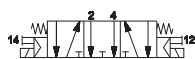
Double impulse



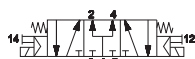
GL-6266



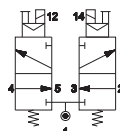
GL-6366



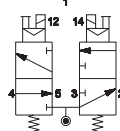
GL-6466



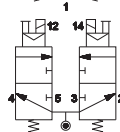
GL-6566



GL-6666



GL-6766



GL-6866

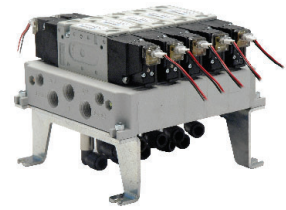
Solenoid valves are supplied without coil and connector

Electrical sub-base

■ Multipolar connection

■ External connection

■ Connector with loose cables



GP-6100

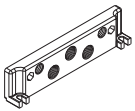
GP-6110

GP-611212

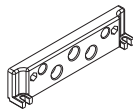
GP-611806

GP-6210/1/2

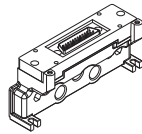
GP-6220/1/2



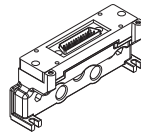
threaded end plate



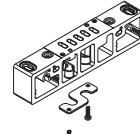
blank end plate



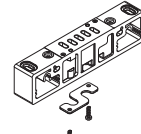
threaded end plate with male connector
25 poles
12+12 coils control 12-14



threaded end plate with male connector
25 poles
18 coils control 14
6 coils control 12



sub-base with open diaphragms
GP-6210 without electrical connection
GP-6211 monostable
GP-6212 bistable



sub-base with closed diaphragms
GP-6220 without electrical connection
GP-6221 monostable
GP-6222 bistable

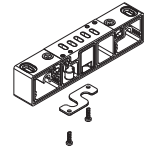
GP-6230/1/2

GP-6240/1/2

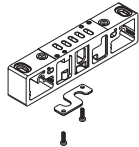
GP-6380

GP-6285

GP-6411



sub-base with closed air supply and open exhausts
GP-6230 without electrical connection
GP-6231 monostable
GP-6232 bistable



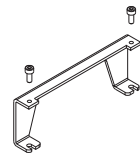
sub-base with open air supply and closed exhausts
GP-6240 without electrical connection
GP-6241 monostable
GP-6242 bistable



intermediate supply plate
(to be used only with GP-63... sub-bases)



closing plate for unused valve place



lifting bracket

GP-6400-1

GP-6400-2

GP-6400-5

GP-6512-01/..MF

GP-6514-01/..MF

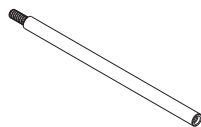
GP-651418



modular tie-rod
1 valve place



modular tie-rod
2 valve places



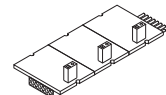
modular tie-rod
5 valve places



BUS connection card control side 12 with 12 pins
GP-6512-01MF 1 place
GP-6512-02MF 2 places
GP-6512-03MF 3 places
GP-6512-05MF 5 places
GP-6512-06MF 6 places



BUS connection card control side 14 with 12 pins
GP-6514-01MF 1 place
GP-6514-02MF 2 places
GP-6514-03MF 3 places
GP-6514-05MF 5 places
GP-6514-06MF 6 places



BUS connection card control side 14 with 18 pins (only 12 places)
for manifolds with control 14 with more than 12 coils (up to 18) use GP-651418 card 12 places and then GP-6514-...

AZ4-SN004A

No. 100 nuts M4 for tie-rods

AZ4-VN0416

No. 100 screws M4x16 for tie-rods

customized solutions up to 12 places available upon request

GZR-100

GZR-V10004/6/8

GZR-V20004/6/8

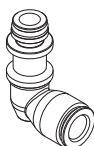
GZR-V20L004/6/8



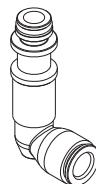
blanking plug



straight fitting
GZR-V10004 tube: 4 mm
GZR-V10006 tube: 6 mm
GZR-V10008 tube: 8 mm



low elbow fitting
GZR-V20004 tube: 4 mm
GZR-V20006 tube: 6 mm
GZR-V20008 tube: 8 mm

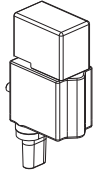


high elbow fitting
GZR-V20L004 tube: 4 mm
GZR-V20L006 tube: 6 mm
GZR-V20L008 tube: 8 mm

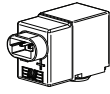
DD-... **DD-051-2C/DD-040-2C** **DE-652I** **D-530-30/50/200**



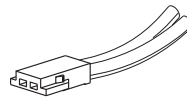
24 V DC 2 W coil for single connection



24 V DC 2 W coil with integrated connector for multipolar version



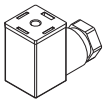
24 V DC 1,35 W coil with in-line connector with protection for a complete tightness



Miniature connector with loose cables
D-530-30 = wire length 300 mm
D-530-50 = wire length 500 mm
D-530-200 = wire length 2000 mm

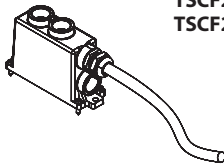
Electrical connections

AM-5109



15 mm connector

TSCF24S0300
TSCF24S0500
TSCF24S1000



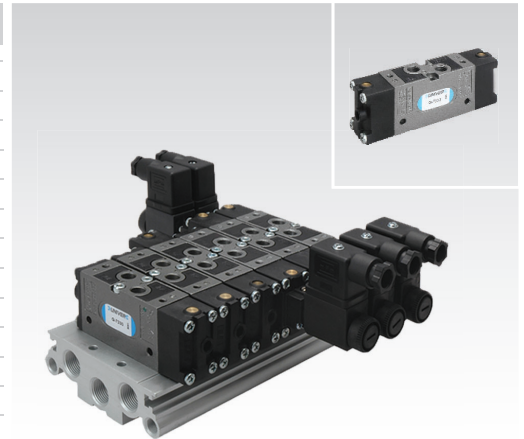
sub-D flying female connector in compliance with CEI 20-22 O.R. II prewired for 24 coils (3-5-10 m length) M3x12 fixing screws

■ Example of panel mounting


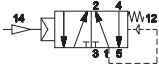
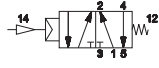



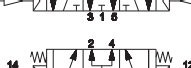



CHARACTERISTICS

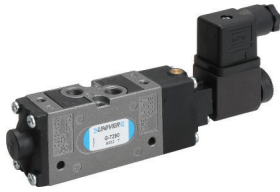
Ambient temperature	-10 ÷ +45 °C
Fluid	50 µm filtered air, with or without lubrication
Commutation system	spool
Max pressure	10 bar
Nominal bore (mm)	6
Nominal flow rate (NI/min)	860
Connector	G1/8
Valve body	zamak
Seals	NBR
Spool	aluminium
Electropilot/Coil	AA series/U1-U3
Power consumption	3,5 W (DC), 5 VA (AC)
Connector	AM-5110
Voltage	12 V DC - 24 V DC - 24 V AC - 110 V AC - 230 V AC
Manual override	impulse screw – 2 positions



Pneumatic impulse

<p>■ Single impulse</p>   G-7230  G-7231	<p>■ Double impulse</p>   G-7233  G-7333  G-7433  G-7533
--	---

Electrical impulse

<p>■ Single impulse</p>   G-7290  G-7291	<p>■ Double impulse</p>   G-7299  G-7399  G-7499  G-7599
--	---

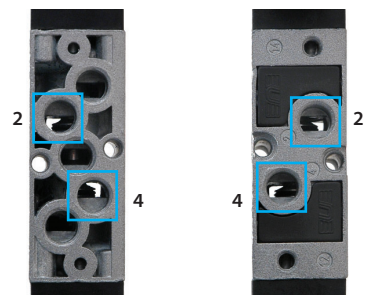
The valve is supplied with two plugs to be fixed with sealants on unused connections 2-4
Solenoid valves are supplied without coil/connector/locking nut
See ATEX Catalogue for types and versions

Multiple sub-base G1/8



	Places		Places
G-7900-02	2	G-7900-08	8
G-7900-03	3	G-7900-09	9
G-7900-04	4	G-7900-10	10
G-7900-05	5	G-7900-11	11
G-7900-06	6	G-7900-12	12
G-7900-07	7		

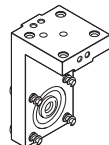
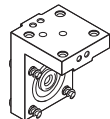
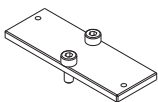
Threaded connections 2 - 4 on both sides of the valve



G-7885

AM-5151

AM-5152



Closing plate for sub-base place

Angle plate for "H" solenoid option

Angle plate for "P" solenoid option

INTEGRATED SUB-BASE

MANIFOLD valve with no sub-base

REDUCED DIMENSIONS

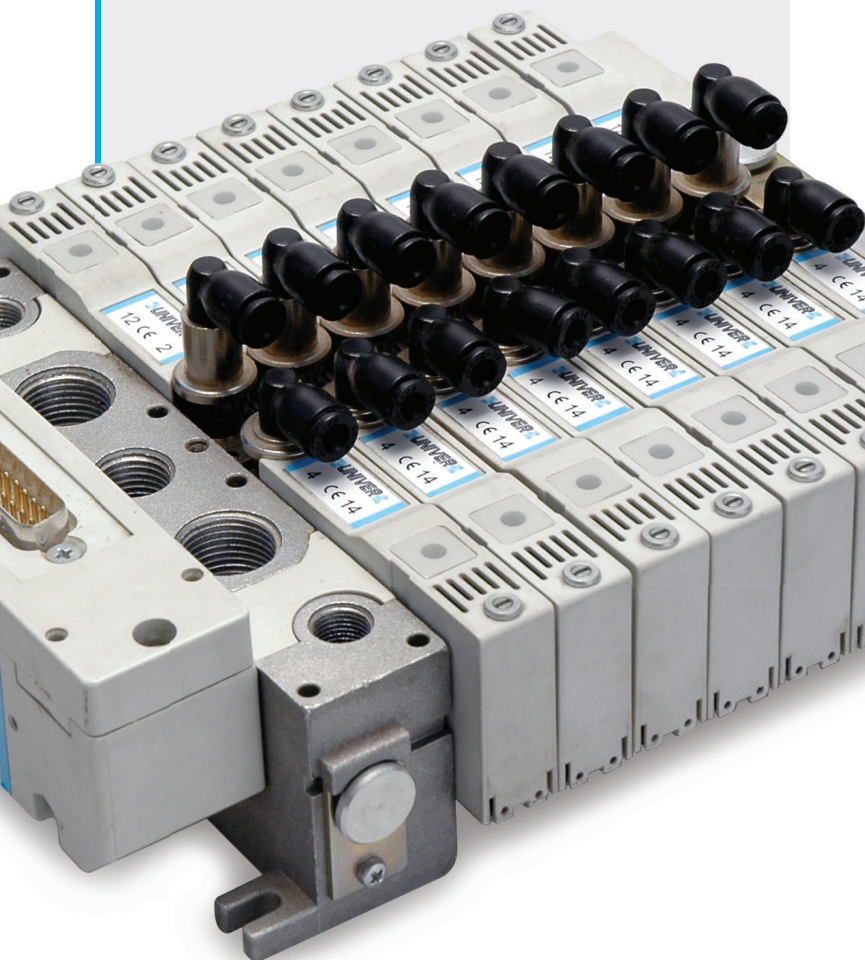
Space saving up to 30% in comparison with standard valve MANIFOLDS

HIGH FLOW RATE

830 NI/min spool system UNIVER Original

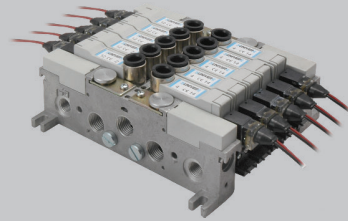
READY TO USE

Prewired configurations of 2 to 20 valves for a quick installation



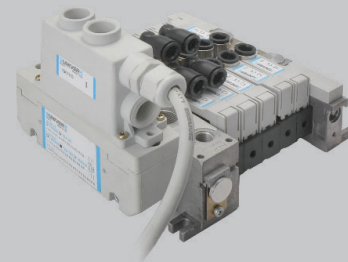
PSC

Single electrical connection



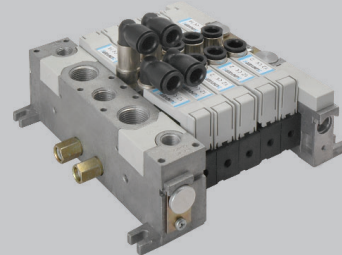
PSP

Multipolar connection

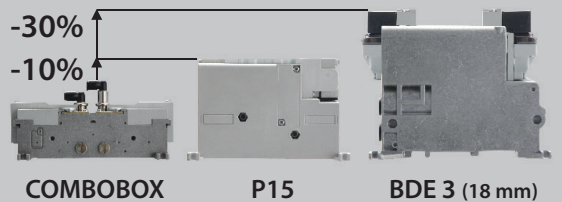


PSR

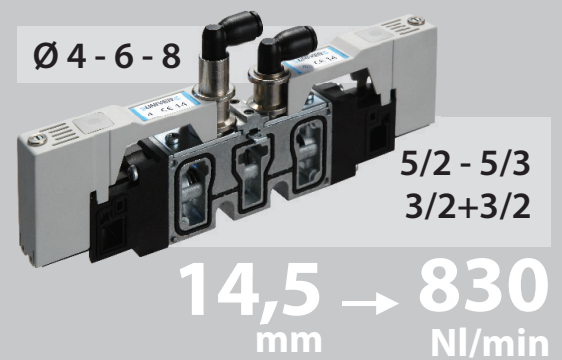
Pneumatic operation connection



REDUCED DIMENSIONS

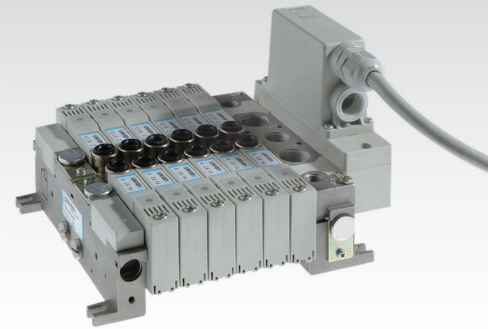


MANIFOLD VALVE without sub-base



CHARACTERISTICS

Ambient temperature	-5 ÷ +50 °C (PSC-PSP), -15 ÷ +50 °C (PSR)
Fluid	10 µm filtered air, with or without lubrication
Commutation system	spool
Max pressure	9 bar (electrical control), 10 bar (pneumatic control)
Nominal bore (mm)	6
Nominal flow rate (NI/min)	depending on the type of fittings (see table)*
Connections	tube Ø 4, 6, 8
Valve body	zamak
Seals	NBR
Spool	aluminium
Electropilot/Coil	B series/U04
Power consumption	1,35 W
Voltage	24 V DC (12 V DC upon request)
Protection degree	IP65
Manual override	recessed button - 1 position (PSC), impulse screw - 1-2 positions (PSP)



*	Ø4	Ø6	Ø8
Straight fitting	200	510	830
Elbow fitting	140	370	700

CODIFICATION KEY

P	S	C	2	6	0	2	4	
1	2	3	4	5	6			

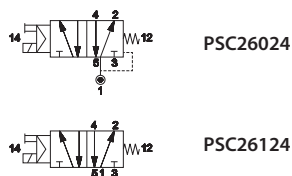
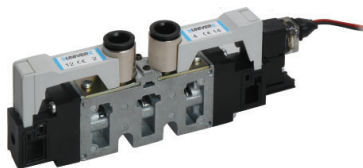
1 Series	2 Type	3 Control 14	4 Return 12
PSC = Separate wires PSP = Plug-in PSR = Pneumatic	2 = 5/2 3 = 5/3 c.c. 4 = 5/3 o.c. 5 = 5/3 p.c. 6 = 3/2+3/2 NC-NC 7 = 3/2+3/2 NC-NO 8 = 3/2+3/2 NO-NO	2 = Pneumatic amplified 6 = Electrical amplified	0 = Pneumatic spring 1 = Mechanical spring 2 = Pneumatic amplified 3 = Pneumatic not amplified 6 = Electrical amplified 7 = Electrical not amplified

5 Voltage and coil	6 ATEX option
Only for PSC and PSP series, assembled coils with standard supplied led 24 = 24 V (standard) 12 = 12 V (upon request)	X = Atex (upon request) See ATEX Catalogue for types and versions

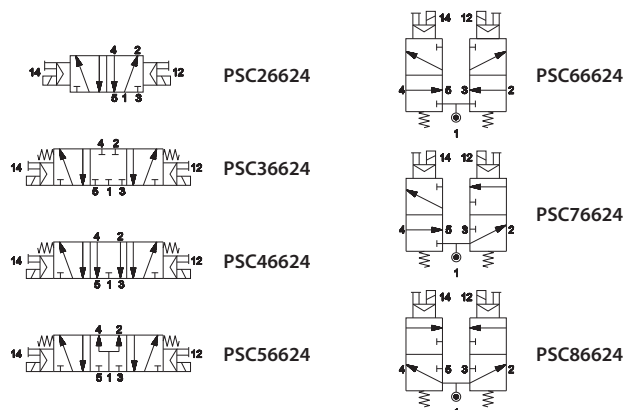
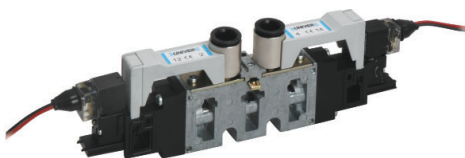
c.c. = closed centres o.c. = open centres p.c. = pressurized centres

PSC Electrical impulse - Electrical connection with separate wires

Single impulse

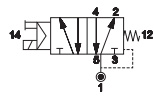


Double impulse

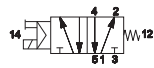


PSP Electrical impulse - Plug-in integrated electrical connection

Single impulse

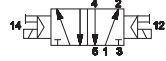


PSP26024

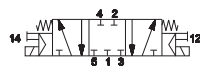


PSP26124

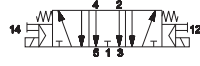
Double impulse



PSP26624



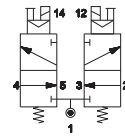
PSP36624



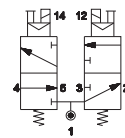
PSP46624



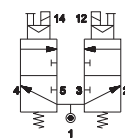
PSP56624



PSP66624



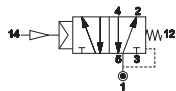
PSP76624



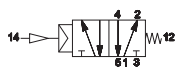
PSP86624

PSR Pneumatic impulse - Pneumatic operation

Single impulse



PSR220



PSR221

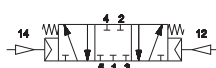
Double impulse



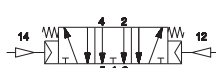
PSR222



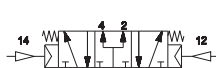
PSR223



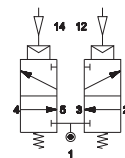
PSR322



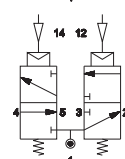
PSR422



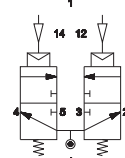
PSR522



PSR622



PSR722



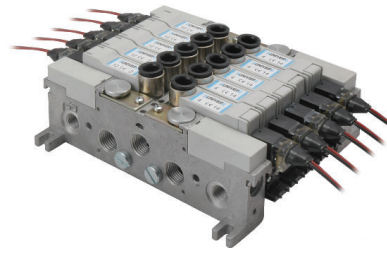
PSR822

PSC Manifold with single electrical connection

- With 26 mm inlet plate and 14,5 mm end plate with DIN rail (EN50022)



- With 14,5 mm inlet and end plate



PSP Manifold with multipolar connection

- With 26 mm inlet plate and 14,5 mm end plate with multipolar connector

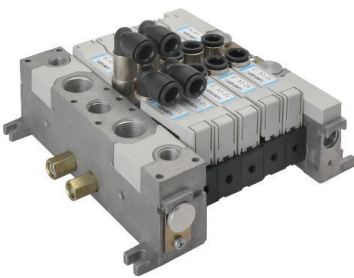


- With 26 mm inlet plate and 14,5 mm end plate with multipolar connector and intermediate plate



PSR Manifold with pneumatic operation

- With 26 mm inlet plate and 14,5 mm end plate



PS14100

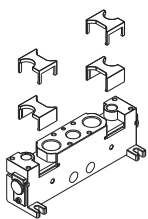
PS14200

PS15000

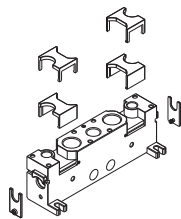
PS15100

PS15200

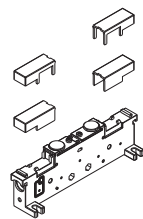
PS15300*



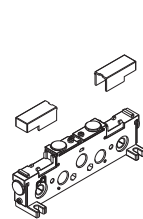
26 mm inlet plate
internal pilot supply



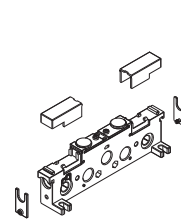
26 mm inlet plate
external pilot supply



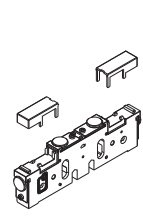
blank plate



14,5 mm inlet plate
internal pilot supply



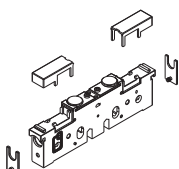
14,5 mm inlet plate
external pilot supply



14,5 mm intermediate
plate, closed air supply,
open exhausts

PS15310*	PS15320*	PS15330*	PS15340	PS15350	PS15360
14,5 mm intermediate plate, open supply, closed exhausts	14,5 mm intermediate blank plate	14,5 mm intermediate open plate	intermediate supply plate with closed exhausts and internal pilot supply	intermediate supply plate with closed exhausts and external pilot supply	intermediate supply plate with open exhausts and internal pilot supply

PS15370



intermediate supply plate with open exhausts and external pilot supply

* = For intermediate plate with closed pilot supply ports add suffix 1 to part number.
The intermediate plate takes one valve place. This needs to be considered for a proper purchase of modular tie rods.

Electropilots are supplied through end plates for internal as well as external supply. In case two different working pressures are applied to the end plates, it is possible to supply either all pilots with one of the two pressures (in general the higher one) or the pilots of each valve group with the working pressure of the same. This is made possible by means of a proper pressure separator. This same principle applies also in presence of more than two different pressures: in this case it is necessary to use intermediate supply plates suitably coupled with pressure separators.

PSK100145	PSK200145	PSK200290	PSK200725	PSK300145	PSK401
tie-rod with hexagonal ends	modular tie-rod L1 = 14,5 mm for each place	modular tie-rod L2 = 29 mm for 2 places	modular tie-rod L5 = 72,5 mm for 5 places	counter tie-rod	Fixing plate for DIN rail connection; with screws

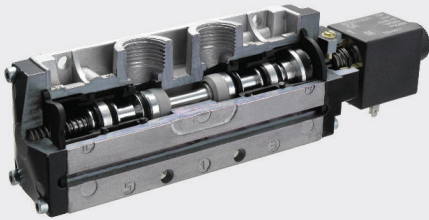
GZR-100	GZR-101	GZR-102	GZR-V10004/6/8	GZR-V20004/6/8	GZR-V20L004/6/8
blanking plug	G1/8 Fitting seat reduction - gas thread for silencer mounting	G1/4 Fitting seat reduction - gas thread for silencer mounting	straight fitting GZR-V10004 tube: 4 mm GZR-V10006 tube: 6 mm GZR-V10008 tube: 8 mm	swivel low elbow fitting GZR-V20004 tube: 4 mm GZR-V20006 tube: 6 mm GZR-V20008 tube: 8 mm	swivel high elbow fitting GZR-V20L004 tube: 4 mm GZR-V20L006 tube: 6 mm GZR-V20L008 tube: 8 mm

TIM06M/10M/20M	TIM06B/10B	D-530C-100/200
male connector 25 poles, prewired for monostable valves (M) TIM06M (Max 6M) TIM10M (Max 10M) TIM20M (Max 20M)	male connector 25 poles, prewired for bistable valves (B) TIM06B (Max 6B) TIM10B (Max 10B)	miniature bipolar flying connector: stripped and tinned for protection D-530C-100 (wire length 1000 mm) D-530C-200 (wire length 2000 mm)

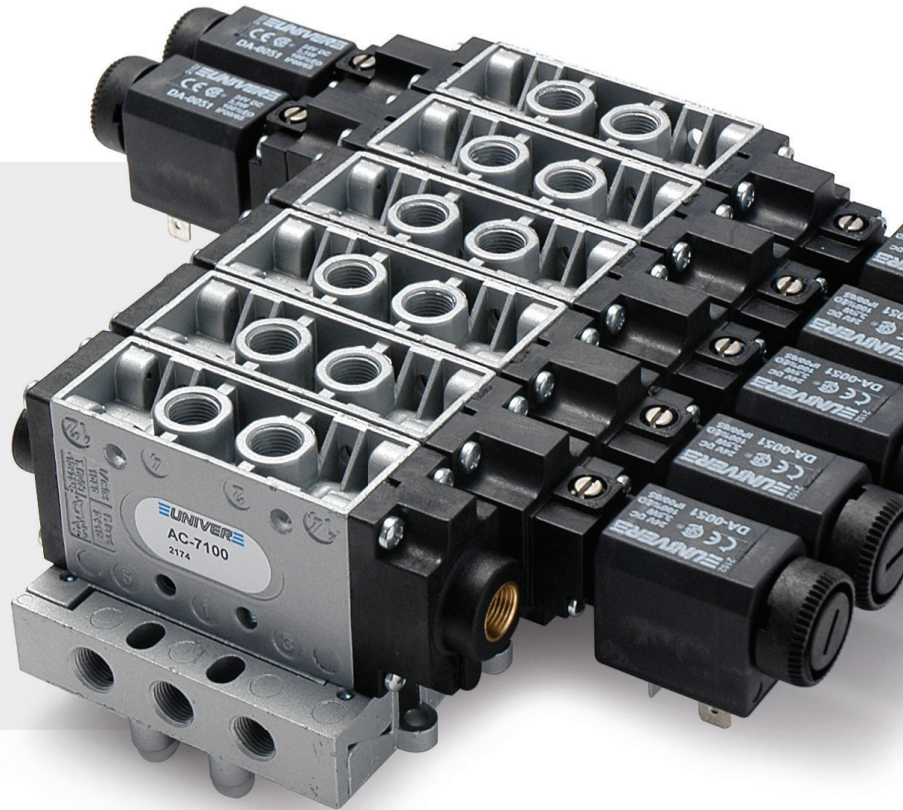
Electrical connections

TSCF000	TSCF24S0300 TSCF24S0500 TSCF24S1000
sub-D female connector 25 poles without cable	sub-D flying female connector in compliance with CEI 20-22 O.R. II prewired for 24 coils (3-5-10 m length) M3x12 fixing screws

MIXED SYSTEM

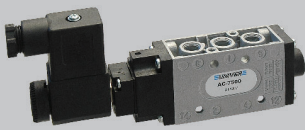


For heavy applications
Fast commutation
Large number of cycles
High flow rate



AC 7

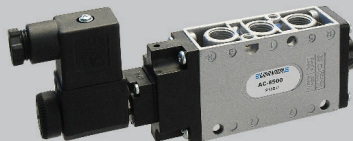
G1/8



1080
NI/min

AC 8

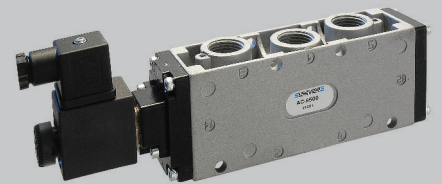
G1/4



1600
NI/min

AC 9

G1/2



4600
NI/min

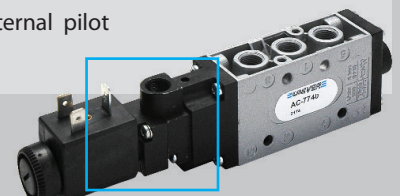
Angle plate for "H"
solenoid option



Angle plate for "P"
solenoid option

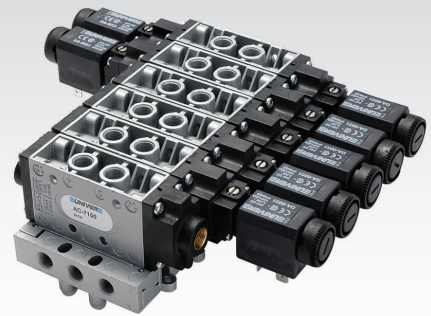


Plate for external pilot
supply



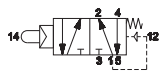
CHARACTERISTICS

Ambient temperature	-10 ÷ +45 °C		
Fluid	50 µm filtered air, with or without lubrication		
Commutation system	poppet mixed system		
Max pressure	10 bar		
Connections	G1/8	G1/4	G1/2
Nominal bore (mm)	6	8	15
Nominal flow rate (NI/min)	1080	1600	4600
Valve body	zamak	zamak	die-cast aluminium
Seals	NBR, polyurethane		
Spool	aluminium		
Electropilot	U1	U1	U2
Coil	DA	DA	DB
Power consumption	3,5 W (DC) - 5 VA (AC)	3,5 W (DC) - 5 VA (AC)	11 W (DC) - 10 VA (AC)
Connector	AM-5110	AM-5110	AM-5111
Voltage	12 V DC - 24 V DC - 24 V AC - 110 V AC - 230 V AC		
Manual override	impulse screw - 2 positions		



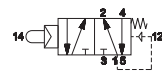
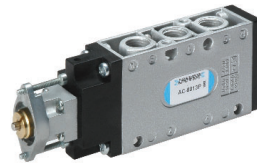
Indirect mechanical operation

■ Preset for pneumatic, mechanical and manual operators

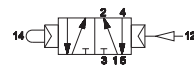


AC-7010 G1/8
AC-8010 G1/4
AC-9010 G1/2

■ Preset for panel operators Ø22



AC-7013 G1/8
AC-8013 G1/4
AC-9013 G1/2

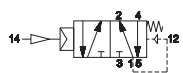


AC-7013P G1/8
AC-8013P G1/4
AC-9013P G1/2

AI-3550	AI-3551	AI-3560	AI-3562	AI-3563	AI-3570	AI-3571	AI-3572	AI-3511Q	AI-3514Q	AI-3515Q	AI-3520Q	AI-3522Q	AI-3524Q	AI-3525Q	AI-3526Q
								AI-3512Q	AI-3516Q	AI-3517Q	AI-3521Q	AI-3522Q (2 pos.)			
								AI-3513Q	AI-3514QD	AI-3519Q		AI-3523Q			
AI-3511	AI-3514	AI-3515	AI-3520	AI-3522	AI-3524	AI-3525	AI-3526								
AI-3512	AI-3516	AI-3517	AI-3521	AI-3522 (2 pos.)											
AI-3513	AI-3514D	AI-3519		AI-3523											
	AI-3516D														

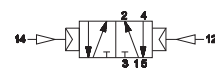
Pneumatic impulse

■ Single impulse



AC-7100 G1/8
AC-8100 G1/4
AC-9100 G1/2

■ Double impulse

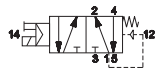


AC-7120 G1/8
AC-8120 G1/4
AC-9120 G1/2

See ATEX Catalogue for types and versions

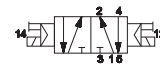
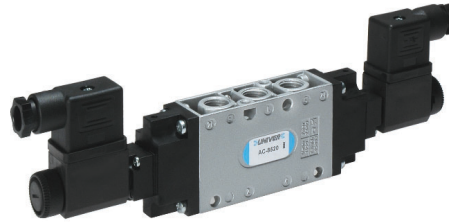
Electrical impulse

■ Single impulse



AC-7500 G1/8
 AC-8500 G1/4
 AC-9500 G1/2

■ Double impulse

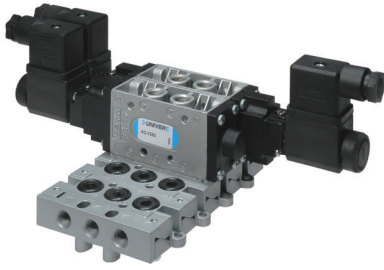


AC-7520 G1/8
 AC-8520 G1/4
 AC-9520 G1/2

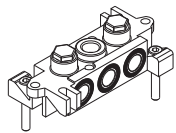
Solenoid valves are supplied without coil/connector/locking nut

Modular sub-base

■ G1/8



AC-7900



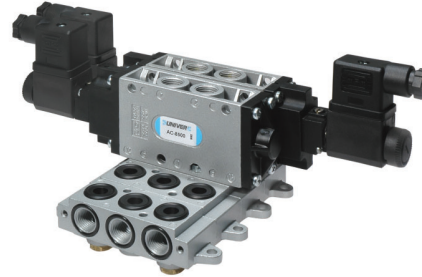
Sub-base with connections
 G1/8

AC-7905

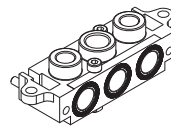


5/2 MIXED system inlet
 plate - G1/8

■ G1/4



AC-8900



Sub-base with threaded
 connections G1/4

Sub-bases are supplied with fixing screws

AM-5148

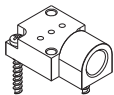
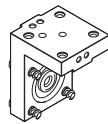


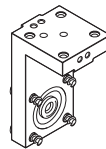
Plate for external pilot supply
 G1/8 - G1/4

AM-5151



Angle plate for "H" solenoid
 option G1/8 - G1/4

AM-5152

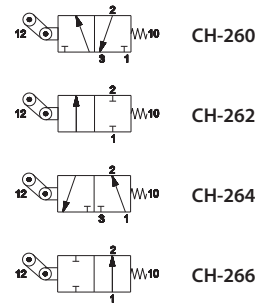
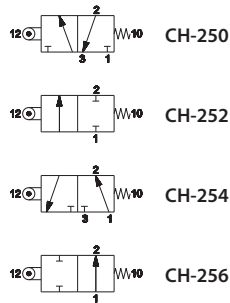
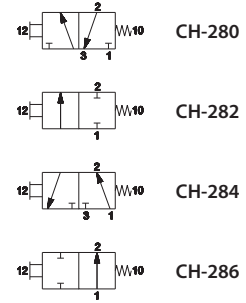
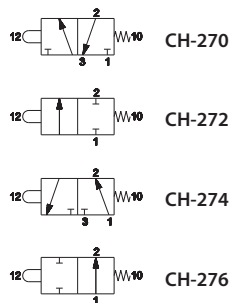


Angle plate for "P" solenoid
 option G1/8 - G1/4

Solenoid valves are supplied without coil, connector and locking nut

CHARACTERISTICS

Ambient temperature	-10 ÷ +45 °C
Fluid	50 µm filtered air, with or without lubrication
Commutation system	poppet
Max pressure	10 bar
Connections	G1/8
Nominal bore (mm)	5
Nominal flow rate (NI/min)	600 (NC), 550 (NO)
Valve body	zamak
Seals	NBR
Spool	nickel-plated brass


Roller lever - spring
One-way roller lever - spring

Ball push - spring
Button lever - spring


AF-AG

Poppet Valves G1/8 ÷ G1 1/2

WIDE RANGE

G1/8 ÷ G1 1/2
2/2 - 3/2 NC-NO

COMPRESSED AIR VERSION




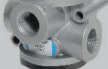

VACUUM VERSION

Available also with external pilot
vacuum supply

HIGH FLOW RATE

Up to **35000 NI/min**
(G1 1/2)



		AF NI/min Compressed air	AG m ³ /h Vacuum
	G1/8 (Ø 5,5)	580	1,5
	G1/4 (Ø 8)	1100	4
	G3/8 (Ø 10)	1500	10
	G1/2 (Ø 15)	5400	20
	G3/4 (Ø 19)	6500	35
	G1 (Ø 25)	13500	90
	G1 1/2 (Ø 39)	35000	180

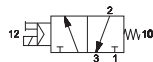
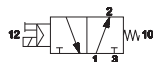
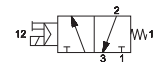
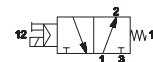
Poppet system

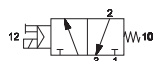
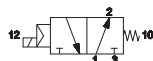
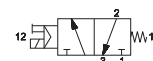
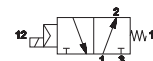
UNIVER Original since 1973

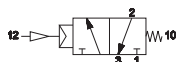
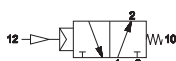
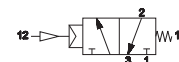
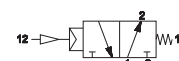


CHARACTERISTICS

Ambient temperature	Max +50 °C						
Fluid	50 µm filtered air, with or without lubrication						
Commutation system	poppet						
Max pressure	10 bar						
Connections	G1/8	G1/4	G3/8	G1/2	G3/4	G1	G1 1/2
Nominal bore (mm)	5,5	8	10	15	19	25	39
Nominal flow rate (NI/min)	580	1100	1500	5400	6500	13500	35000
Valve body	zamak (G1/8 ÷ G1), aluminium (G1 1/2)						
Seals	polyurethane conical poppets and Vulkollan diaphragm						
Spool	aluminium (G1/8 ÷ G3/8), steel + plastic (G1/2 ÷ G1 1/2)						
	G1/8			G1/4 ÷ G1 1/2			
Electropilot	U1			U2			
Coil	DA			DB			
Power consumption	3,5 W (DC) - 5 VA (AC)			11 W (DC) - 10 VA (AC)			
Connector	AM-5110			AM-5111			
Voltage	12 V DC - 24 V DC - 24 V AC - 110 V AC - 230 V AC						
Manual override	impulse screw - 2 positions						


Solenoid valves G1/8 ÷ G3/8

 3/2 NC
 AF-2500 G1/8 U1

 3/2 NO
 AF-2501 G1/8 U1

 3/2 NC
 AF-2510 G1/4 U1
 AF-2517 G1/4 U2
 AF-2520 G3/8 U1
 AF-2524 G3/8 U2

 3/2 NO
 AF-2511 G1/4 U1
 AF-2518 G1/4 U2
 AF-2521 G3/8 U1
 AF-2525 G3/8 U2

Solenoid valves G1/2 ÷ G1 1/2

 3/2 NC
 AF-2530 G1/2 U2
 AF-2540 G3/4 U2
 AF-2545 G1 U2

 3/2 NO
 AF-2531 G1/2 U2
 AF-2541 G3/4 U2
 AF-2546 G1 U2

 3/2 NC
 AF-2565 G1 1/2 U2

 3/2 NO
 AF-2561 G1 1/2 U2

Pneumatic valves with external operation G1/8 ÷ G3/8

 3/2 NC
 AF-2600 G1/8

 3/2 NO
 AF-2700 G1/8

 3/2 NC
 AF-2601 G1/4
 AF-2606 G3/8

 3/2 NO
 AF-2701 G1/4
 AF-2706 G3/8

Compressed air power-operated 2/2 version valves available upon request
 Solenoid valves are supplied without coil, connector and locking nut
 See ATEX Catalogue for types and versions

Pneumatic valves with external operation G1/2 ÷ G1 1/2

		<p>3/2 NC-NO AF-2603 G1/2 AF-2610 G3/4 AF-2615 G1</p>			<p>3/2 NC-NO AF-2620 G1 1/2</p>
--	--	--	--	--	--

2/2 Solenoid valve for blowing G1

2/2 Pneumatic valve for blowing with ext. operation G1

		<p>2/2 NC AF-2550 G1 2/2 NC AF-2551 G1 2/2 NC AF-2552 G1</p>			<p>2/2 NC AF-2617 G1</p>
--	--	---	--	--	---

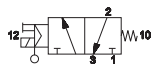
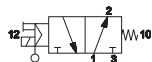
Solenoid valves are supplied without coil/connector/locking nut

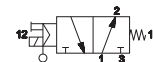
CHARACTERISTICS

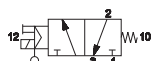
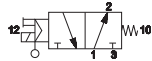
Ambient temperature	Max +50 °C						
Fluid	50 µm filtered air, with or without lubrication - vacuum						
Commutation system	poppet						
Max vacuum	759,5 mm Hg						
Connections	G1/8	G1/4	G3/8	G1/2	G3/4	G1	G1 1/2
Nominal bore (mm)	5,5	8	10	15	19	25	39
Valve body	zamak (G1/8 ÷ G1), aluminium (G1 1/2)						
Seals	polyurethane conical poppets and Vulkollan diaphragm ^(a) ; silicon poppets ^(b)						
Spool	aluminium (G1/8 ÷ G3/8), steel + plastic (G1/2 ÷ G1 1/2)						
	G1/8			G1/4 ÷ G1 1/2			
Electropilot	U1			U2			
Coil	DA			DB			
Power consumption	3,5 W (DC) - 5 VA (AC)			11 W (DC) - 10 VA (AC)			
Connector	AM-5110			AM-5111			
Voltage	12 V DC - 24 V DC - 24 V AC - 110 V AC - 230 V AC						
Manual override	impulse screw - 2 positions						

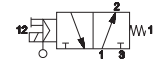
(a) = valve for vacuum with external air operation

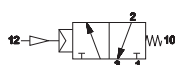
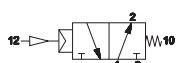
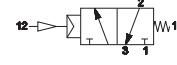
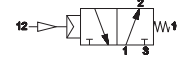
(b) = valve for direct vacuum with external vacuum operation


3/3 Solenoid valve for vacuum with external pilot air supply G1/8 ÷ G3/8

 3/2 NC
AG-3001 G1/8

 3/2 NO
AG-3002 G1/8

 3/2 NC
AG-3009 G1/4
AG-3011 G3/8

 3/2 NO
AG-3010 G1/4
AG-3012 G3/8

3/2 Solenoid valve for vacuum with external pilot air supply G1/2 ÷ G1 1/2

 3/2 NC
AG-3020 G1/2
AG-3040 G3/4
AG-3050 G1

 3/2 NO
AG-3021 G1/2
AG-3041 G3/4
AG-3051 G1

 3/2 NC
AG-3062 G1 1/2

 3/2 NO
AG-3063 G1 1/2

3/2 Pneumatic valve for vacuum with external air operation G1/8 ÷ G3/8

 3/2 NC
AG-3071 G1/8

 3/2 NO
AG-3072 G1/8

 3/2 NC
AG-3073 G1/4
AG-3075 G3/8

 3/2 NO
AG-3074 G1/4
AG-3076 G3/8

2/2 NC-NO versions available upon request
Solenoid valves are supplied without coil/connector/locking nut
See ATEX Catalogue for types and versions

3/2 Pneumatic valve for vacuum with external air operation G1/2 ÷ G1 1/2



3/2 NC
 AG-3081 G1/2
 AG-3091 G3/4
 AG-3100 G1

3/2 NO
 AG-3082 G1/2
 AG-3092 G3/4
 AG-3101 G1



3/2 NC
 AG-3110 G1 1/2

3/2 NO
 AG-3111 G1 1/2

3/2 Solenoid valve for direct vacuum with pilot vacuum supply G1/4 ÷ G1 1/2



3/2 NC
 AG-3210 G1/4
 AG-3214 G3/8

3/2 NO
 AG-3211 G1/4
 AG-3215 G3/8



3/2 NC
 AG-3222 G1/2
 AG-3232 G3/4
 AG-3242 G1

3/2 NO
 AG-3223 G1/2
 AG-3233 G3/4
 AG-3243 G1



3/2 NC
 AG-3256 G1 1/2

3/2 NO
 AG-3257 G1 1/2

2/2 - 3/2 Solenoid valve for vacuum with direct operation G1/4 - G1/2



3/2 NC^(a)
 AG-3310 G1/4 Ø 3 mm
 AG-3311 G1/4 Ø 4 mm
 AG-3312 G1/4 Ø 5 mm
 AG-3313 G1/4 Ø 6 mm

2/2 NC
 AG-3300 G1/4 Ø 3 mm
 AG-3301 G1/4 Ø 4 mm
 AG-3302 G1/4 Ø 5 mm
 AG-3303 G1/4 Ø 6 mm

(a) = Fixed discharge Ø 3 mm



3/2 NC^(a)
 AG-3330 G1/2 Ø 8 mm
 AG-3331 G1/2 Ø 10 mm
 AG-3332 G1/2 Ø 11 mm

2/2 NC
 AG-3320 G1/2 Ø 8 mm
 AG-3321 G1/2 Ø 10 mm
 AG-3322 G1/2 Ø 11 mm

(a) = Fixed discharge Ø 3 mm

■ U2 - 17 VA coil

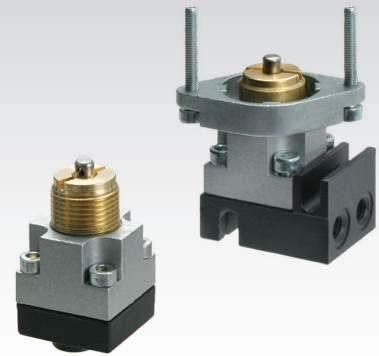


DB-0607 24V AC - 50/60 Hz
 DB-0608 110V AC - 50/60 Hz
 DB-0610 220V AC - 50/60 Hz

Solenoid valves are supplied without coil/connector/locking nut

CHARACTERISTICS

Ambient temperature	-10 ÷ +90 °C	
Fluid	50 µm filtered air, with or without lubrication	
Commutation system	poppet	
Max pressure	10 bar	
Connections	interface for sub-base	
	standard	sensible
Nominal bore (mm)	2,3	1,5
Nominal flow rate (NI/min)	110	55
Force (N)	5	4
Valve body	zamak	
Seals	NBR	
Spool	nickel-plated brass	



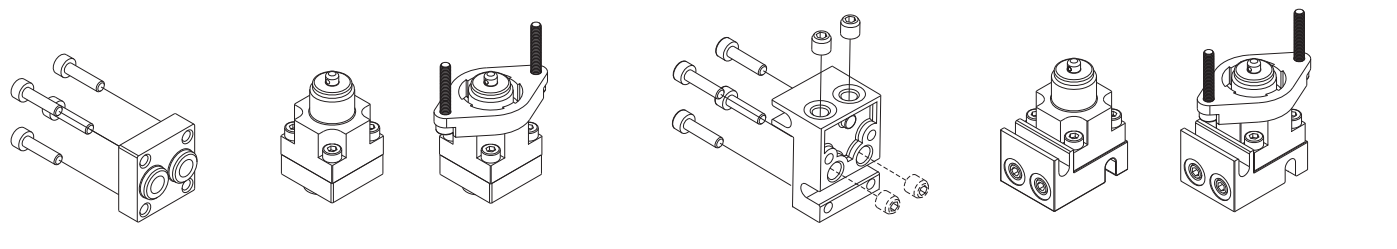
Mechanical push button - spring

Mechanical push button for panel operation - spring

		AI-3500 standard AI-3500S sensible			AI-3500Q standard AI-3500SQ sensible											
		AI-3501 standard AI-3501S sensible			AI-3501Q standard AI-3501SQ sensible											
		AI-3502 standard			AI-3502Q standard											
		AI-3503 2/2 NO Available upon request			AI-3503Q 2/2 NO Available upon request											
AI-3550	AI-3551	AI-3560	AI-3562	AI-3563	AI-3570	AI-3571	AI-3572	AI-3511Q	AI-3514Q	AI-3515Q	AI-3520Q	AI-3524Q	AI-3522Q (2 pos.)	AI-3525Q	AI-3526Q	
AI-3512	AI-3513	AI-3514D	AI-3516D	AI-3517	AI-3519	AI-3521	AI-3523	AI-3512Q	AI-3516Q	AI-3517Q	AI-3521Q	AI-3513Q	AI-3514QD	AI-3519Q	AI-3516QD	AI-3523Q

AI-3610

AI-3612



Sub-base with bottom connections M5

Sub-base with side or bottom connections M5

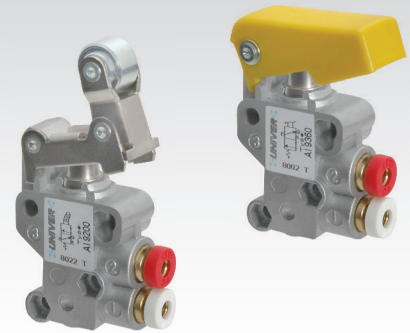
Sub-bases are supplied with M3x12 fixing screws (4 pcs) and M5x5 grub screws (2pcs) to close the unused ways.

Grub screws must be fixed with sealing loctite (243 type), being sure that loctite does not obstruct the ports or sink inside the valve. Grub screws must be screwed until reaching the base surface. Avoid screwing them completely.

See ATEX Catalogue for types and versions

CHARACTERISTICS

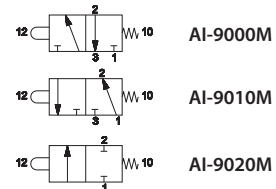
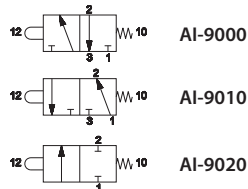
Ambient temperature	-10 ÷ +90 °C
Fluid	50 µm filtered air, with or without lubrication
Commutation system	poppet
Max pressure	10 bar
Connections	M5, tube Ø4
Nominal bore (mm)	2,5
Nominal flow rate (NI/min)	70
Valve body	zamak
Seals	NBR
Spool	nickel-plated brass



Ball push - spring

■ Tube Ø4

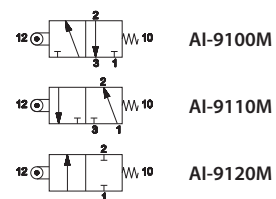
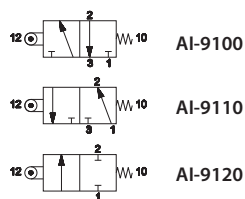
■ M5



Roller lever - spring

■ Tube Ø4

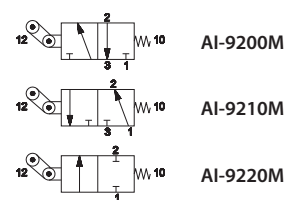
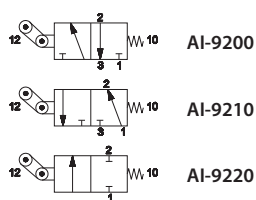
■ M5



One-way roller lever - spring

■ Tube Ø4

■ M5

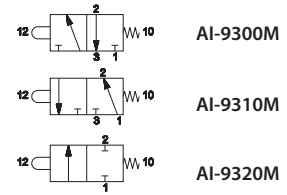
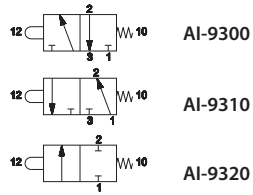


See ATEX Catalogue for types and versions

Bulkhead mechanical push button - spring

■ Tube Ø4

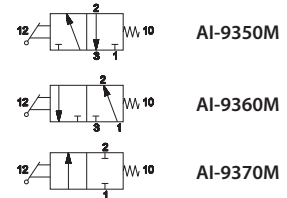
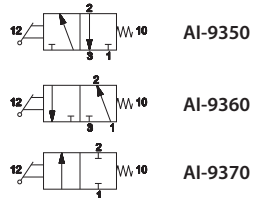
■ M5



Button lever - spring

■ Tube Ø4

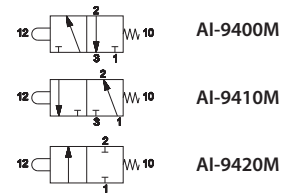
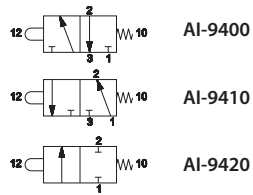
■ M5



Mechanical push button for panel operation - spring

■ Tube Ø4

■ M5



AI-3511Q ■	AI-3514Q ■	AI-3515Q ■	AI-3520Q ■	AI-3524Q ■	AI-3522Q ■	AI-3525Q ■	AI-3526Q ■
AI-3512Q ■	AI-3516Q ■	AI-3517Q ■	AI-3521Q ■		(2 pos.)		
AI-3513Q ■	AI-3514QD ■	AI-3519Q ■			AI-3523Q ■		
	AI-3516QD ■						

CHARACTERISTICS

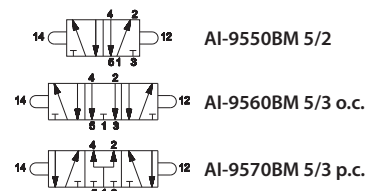
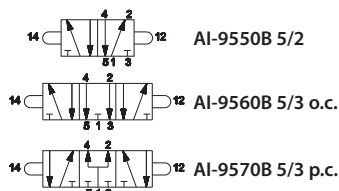
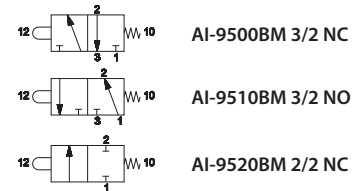
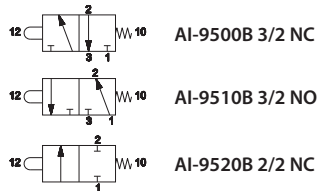
Ambient temperature	-10 ÷ +90 °C
Fluid	50 µm filtered air, with or without lubrication
Commutation system	poppet
Max pressure	10 bar
Connections	M5, tube Ø4
Nominal bore (mm)	2,5
Nominal flow rate (NI/min)	70
Valve body	zamak
Seals	NBR
Spool	nickel-plated brass



Mechanical push button for panel mounting

■ Tube Ø4

■ M5



o.c. = open centres p.c. = pressurized centres



Recessed button

- AI-35B10N ■
- AI-35B10R ■
- AI-35B10V ■



Protruding button

- AI-35B11N ■
- AI-35B11R ■
- AI-35B11V ■



Two-position head button

- AI-35B13N ■
- AI-35B13R ■



Short lever selector

- AI-35B20 2 steady positions
- AI-35B21 3 unsteady positions
- AI-35B22 3 steady positions



Long lever selector

- AI-35B25 2 steady positions
- AI-35B26 3 unsteady positions
- AI-35B27 3 steady positions



Key selector
(extractable key)

- AI-35B30 2 steady positions
- AI-35B31 3 unsteady positions
- AI-35B32 3 steady positions

CHARACTERISTICS

Ambient temperature	-10 ÷ +70 °C	
Fluid	filtered air 50 µm, with or without lubrication	
Commutation system	poppet	
Max pressure	10 bar	
Connections	G1/8	G1/4
Nominal bore (mm)	2,3	8
Nominal flow rate (NI/min)	98	800
PNEUMATIC FOOT VALVE:		
Valve body	zamak	
Foot valve lever	aluminium	
Pedal body and protection	plastic material with reinforcing steel plate	
Seals	oil and wear resistant compound	
Spool	aluminium	
SOLENOID FOOT VALVE		
Valve body, foot valve lever, protection	dielectric plastic material	



Pneumatic foot valve G1/4 with protection

<p>■ Spring return</p> <p> AM-5000</p> <p> AM-5001</p> <p> AM-5002</p>	<p>■ Bistable</p> <p> AM-5003</p> <p> AM-5004</p> <p> AM-5005</p>	<p>■ With safety control</p> <p> AM-5015</p> <p> AM-5011</p> <p> AM-5012</p>
<p>■ External operation - Spring return</p> <p> AM-5021</p>	<p>■ External operation - bistable</p> <p> AM-5031</p>	<p>■ External operation with safety control</p> <p> AM-5041</p>

Pneumatic foot valve G1/4 without protection

<p>■ Spring return</p> <p> AM-5000A</p> <p> AM-5001A</p>	<p>■ Bistable</p> <p> AM-5003A</p> <p> AM-5004A</p>
--	---

Pneumatic foot valve G1/8 with protection

Solenoid foot valve

<p>■ Spring return</p> <p> AM-5043</p> <p> AM-5043B</p> <p> AM-5043C</p> <p> AM-5043D</p>	<p> AM-5050 No electrical microswitch</p> <p> AM-5051 Electrical microswitch</p> <p> AM-5052 Double electrical microswitch</p>
---	--

Version without protection available upon request

See ATEX Catalogue for types and versions

HIGH FLOW RATE

310 NI/min (UNIVER traditional spool technology)

COMPACT SIZE: 10 mm

Highest reduction of overall dimensions

EASY INSTALLATION

All pneumatic connections on the same side

COMPLETE SOLUTION

Threaded body and body for sub-base mounting

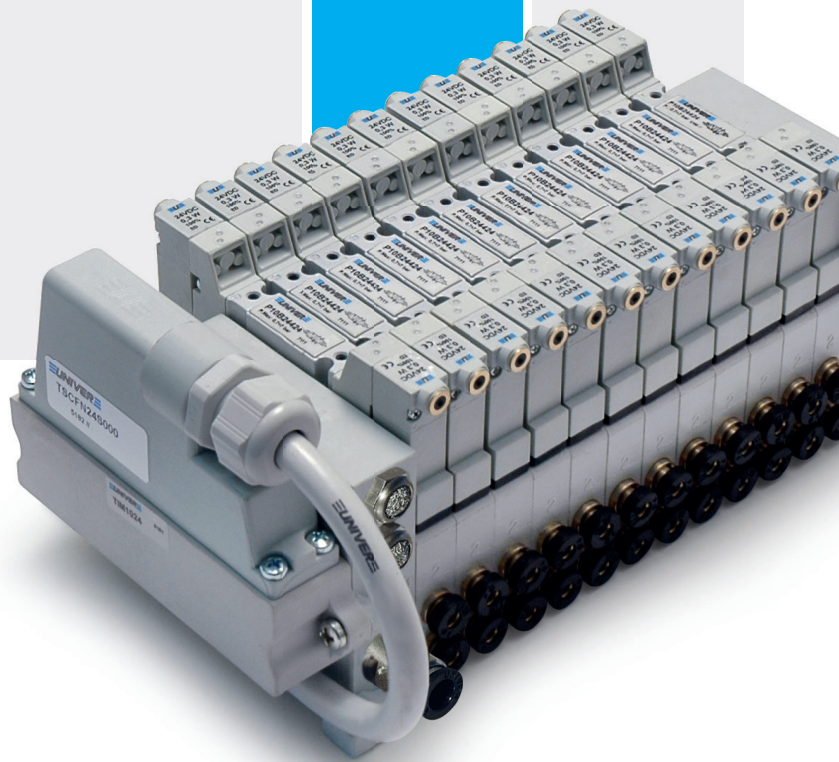
5/2 - 5/3 - 3/2+3/2

1 w

Standard

0,3 w

Low consumption



P10F



P10B



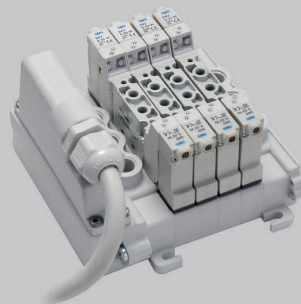
P10F

Threaded ports (M5)

Electrical connection with external connector



Integrated electrical connection



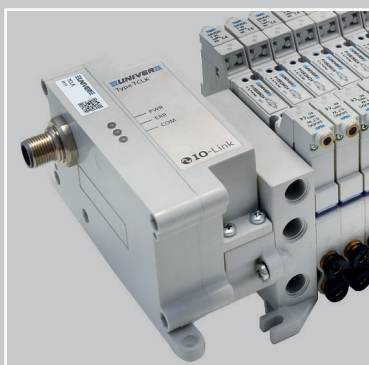
P10B

For sub-base (M5-M7-Tube 4)

Integrated electrical connection



Available with IO-Link connection



CANopen

DeviceNet

PROFINET

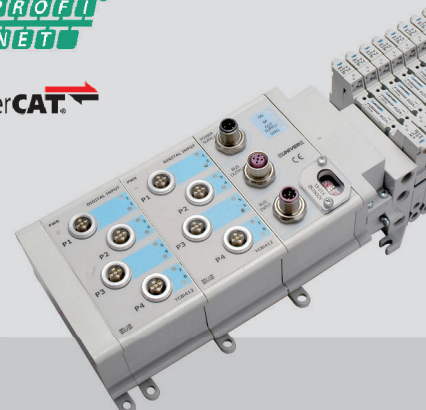
PROFIBUS

EtherNet/IP

EtherCAT

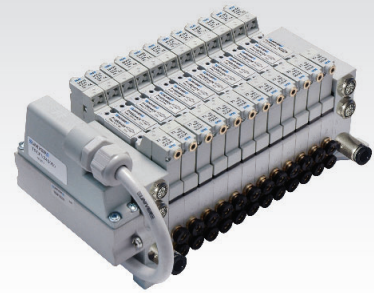
TC Series

Connection to modular serial communication system



CHARACTERISTICS

Ambient temperature	-5 ÷ +50 °C
Fluid	10 µm filtered air, with or without lubrication
Commutation system	spool
Max pressure	7 bar (electrical control) 10 bar (pneumatic control)
Connections	M5 (P10F) - M5, M7, tube Ø 4 (P10B)
Nominal flow rate (NI/min)	310 (5/2) 230 (5/3) 250 (3/2+3/2)
Valve body	zamak
Seals	NBR
Electropilot	B10 (0,3W) - B11 (1 W)
Spool	aluminium
Voltage	24 V DC (± 10%)
Power consumption	B10 = 0,3 W, Speed-up 1,3 W (25 ms) B11 = 1 W
Protection degree	IP65
Manual override	recessed button - 1 position



CODIFICATION KEY

P	1	0	F	2	4	4	2	4		
	1			2	3	4	5	6	7	

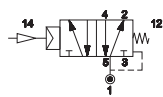
1 Series	2 Type	3 Control 14	4 Return 12
P10F = Threaded body P10B = Body for sub-base	2 = 5/2 6 = 3/2+3/2 NC-NC 3 = 5/3 c.c. 7 = 3/2+3/2 NC-NO 4 = 5/3 o.c. 8 = 3/2+3/2 NO-NO 5 = 5/3 p.c.	3 = Pneumatic amplified 4 = Electrical amplified 90° (0,3W) 6 = Electrical amplified 90° (1W)	0 = Pneumomechanical spring 1 = Mechanical spring 3 = Pneumatic amplified 4 = Electrical amplified 90° (0,3W) 6 = Electrical amplified 90° (1W)
5 Voltage	6 Option	7 ATEX Option	
24 = 24 V DC	D = External pilot supply on valve body (P10 = M3)	X = Atex (upon request)	

See ATEX Catalogue for types and versions

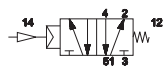
c.c. = closed centres o.c. = open centres p.c. = pressurized centres

Pneumatic impulse - Threaded connections M5

Single impulse



P10F230



P10F231

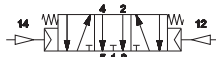
Double impulse



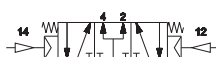
P10F233



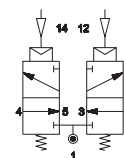
P10F333



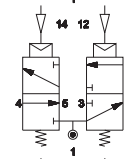
P10F433



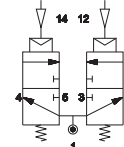
P10F533



P10F633



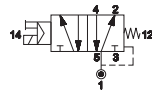
P10F733



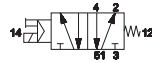
P10F833

Electrical impulse - Threaded connections M5

Single impulse



P10F24024 0,3 W
P10F26024 1 W



P10F24124 0,3 W
P10F26124 1 W

B10



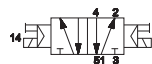
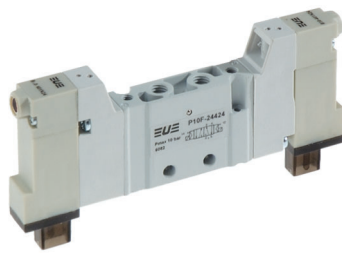
Low power consumption 0,3 W

B11

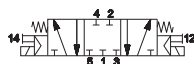


Standard 1 W

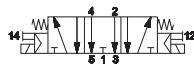
Double impulse



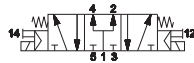
P10F24424 0,3 W
P10F26624 1 W



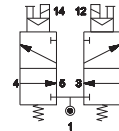
P10F34424 0,3 W
P10F36624 1 W



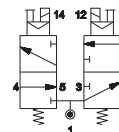
P10F44424 0,3 W
P10F46624 1 W



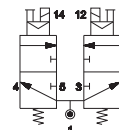
P10F54424 0,3 W
P10F56624 1 W



P10F64424 0,3 W
P10F66624 1 W

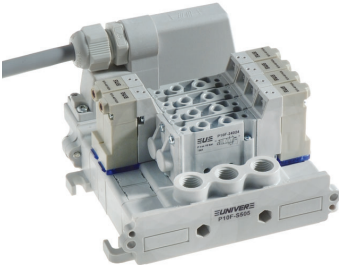


P10F74424 0,3 W
P10F76624 1 W



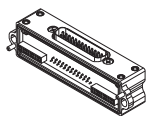
P10F84424 0,3 W
P10F86624 1 W

Integrated electrical connection - Threaded connections M5



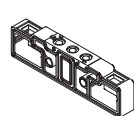
Configuration 25p conn.
max 12 bistable

TIM1024



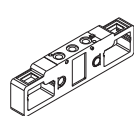
male connection module
25 poles, type sub-D

P10SF100



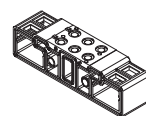
sub-base 1 place

P10SF110



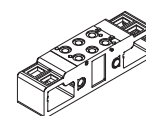
sub-base 1 place
1-3-5 closed

P10SF200



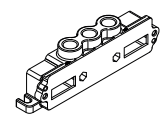
sub-base 2 places

P10SF210



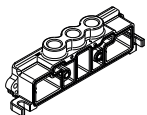
sub-base 2 places
1-3-5 closed

P10SF500



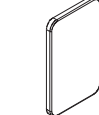
left supply plate G1/8
for TIM module

P10SF505



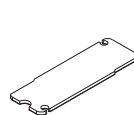
right supply plate G1/8

P10SF550



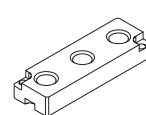
pressure separator

P10SF560



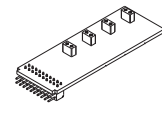
closing plate for unused
valve place

P10SF570



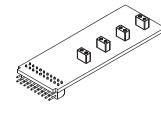
intermediate supply plate
for threaded version

P10SS14**M



bus connection card,
side 14
** = 04, 06, 08, 10, 12 places

P10SS12**M



bus connection card,
side 12
** = 04, 06, 08, 10, 12 places

P10STR01



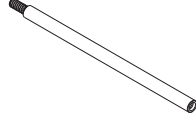
modular tie-rods
1 valve place

P10STR02



modular tie-rods
2 valve places

P10STR05



modular tie-rods
5 valve places

AZ4-SN003A

No. 100 nuts M3 for tie-rods

AZ4-VN0310

No. 100 screws M3x10 for tie-rods

Electrical connection with external connector - Threaded connections M5

3



P10SF300	P10SF310	P10SF400	P10SF410	P10SF515	P10SF550
sub-base 1 place	sub-base 1 place 1-3-5 closed	sub-base 2 places	sub-base 2 places 1-3-5 closed	right/left supply place G1/8	pressure separator
P10SF560	P10SF570	P10STR01	P10STR02	P10STR05	
closing plate for unused valve place	intermediate supply plate for threaded version	modular tie-rod 1 valve place	modular tie-rod 2 valve places	modular tie-rod 5 valve places	

AZ4-SN003A

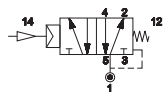
No. 100 nuts M3
for tie-rods

AZ4-VN0310

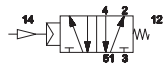
No. 100 screws M3x10
for tie-rods

Pneumatic impulse - Body for sub-base mounting

■ Single impulse



P10B230

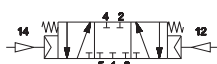


P10B231

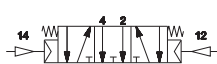
■ Double impulse



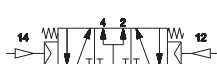
P10B233



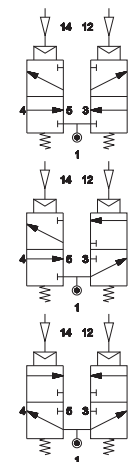
P10B333



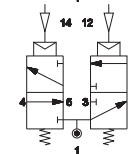
P10B433



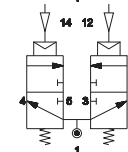
P10B533



P10B633



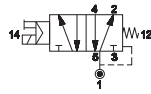
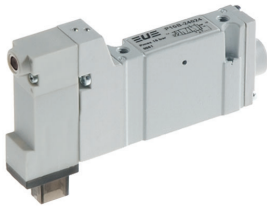
P10B733



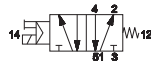
P10B833

Electrical impulse - Body for sub-base mounting

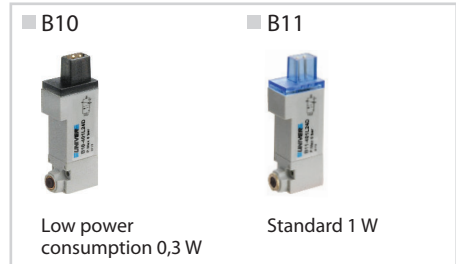
Single impulse



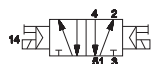
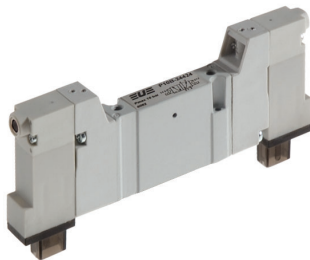
P10B24024 0,3 W
P10B26024 1 W



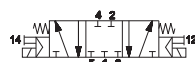
P10B24124 0,3 W
P10B26124 1 W



Double impulse



P10B24424 0,3 W
P10B26624 1 W



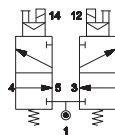
P10B34424 0,3 W
P10B36624 1 W



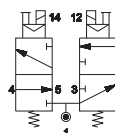
P10B44424 0,3 W
P10B46624 1 W



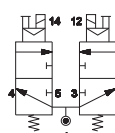
P10B54424 0,3 W
P10B56624 1 W



P10B64424 0,3 W
P10B66624 1 W

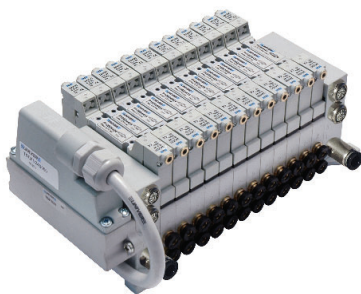


P10B74424 0,3 W
P10B76624 1 W



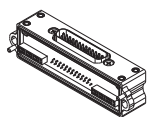
P10B84424 0,3 W
P10B86624 1 W

Integrated electrical connection - Body for sub-base mounting



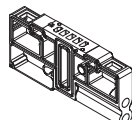
Configuration 25p conn.
max 12 bistable

TIM1024



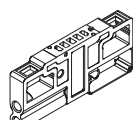
male connection module
25 poles, type sub-D

P10SB100/107



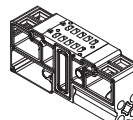
sub-base 1 place
side outlets M5, M7

P10SB110/117



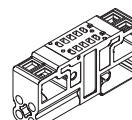
sub-base 1 place
side outlets M5, M7
1-3-5 closed

P10SB200/207



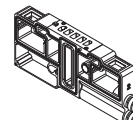
sub-base 2 places
side outlets M5, M7

P10SB210/217



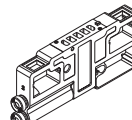
sub-base 2 places
side outlets M5, M7
1-3-5 closed

P10SB304



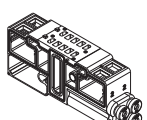
sub-base 1 place
side outlets with push-in
connections tube 4

P10SB314



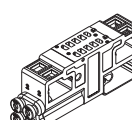
sub-base 1 place side
outlets with push-in
connections tube 4
1-3-5 closed

P10SB404



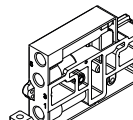
sub-base 2 places
side outlets with
push-in connections
tube 4

P10SB414



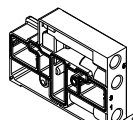
sub-base 2 places
side outlets with push-in
connections tube 4
1-3-5 closed

P10SB500



supply plate G1/8
for TIM module

P10SB505



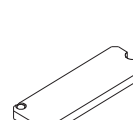
right supply plate G1/8

P10SB550



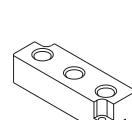
pressure separator

P10SB560



closing plate for unused
valve place

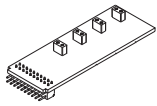
P10SB570



intermediate supply
plate for sub-base
version

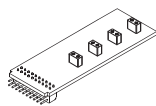
3

P10SS14M**



bus connection card, side 14
** = 04, 06, 08, 10, 12 places

P10SS12M**



bus connection card, side 12
** = 04, 06, 08, 10, 12 places

P10STR01



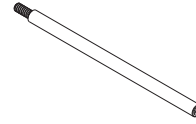
modular tie-rods
1 valve place

P10STR02



modular tie-rods
2 valve places

P10STR05



modular tie-rods
5 valve places

AZ4-SN003A

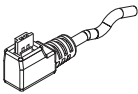
No. 100 nuts M3 for tie-rods

AZ4-VN0310

No. 100 screws M3x10 for tie-rods

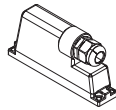
Electrical connections

D-535U40300
D-535U40500



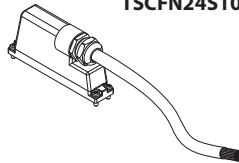
single connector cable 3-5 m

TSCFN24S000



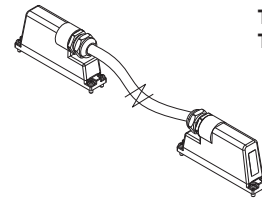
female connector
25 poles, type sub-D, no cable
M3x8 fixing screws

TSCFN24S0300
TSCFN24S0500
TSCFN24S1000



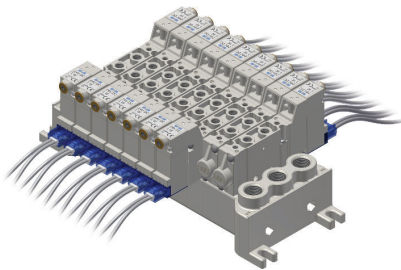
female connector
25 poles, type sub-D, prewired for 24
coils (3-5-10 m length)
M3x8 fixing screws

TSCFN16D0300
TSCFN16D0500
TSCFN16D1000

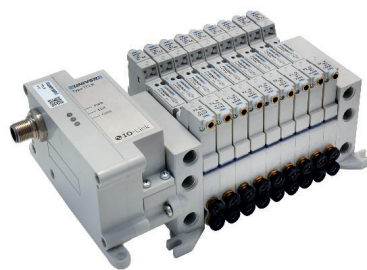


sub-D male/female flying connector (upon request)
prewired for 16 coils with cable Ø 8 mm (3-5-10 m length)
suitable for dynamic laying - M3x8 fixing screws

■ In-line connections



■ IO-Link connection



■ TC series Serial Communication System



HIGH FLOW RATE

800 NI/min (UNIVER traditional spool technology)

COMPACT SIZE: 15 mm

Highest reduction of overall dimensions

EASY INSTALLATION

All pneumatic connections on the same side

COMPLETE SOLUTION

Threaded body and body for sub-base mounting

5/2 - 5/3 - 3/2+3/2

NEW VERSION P15B

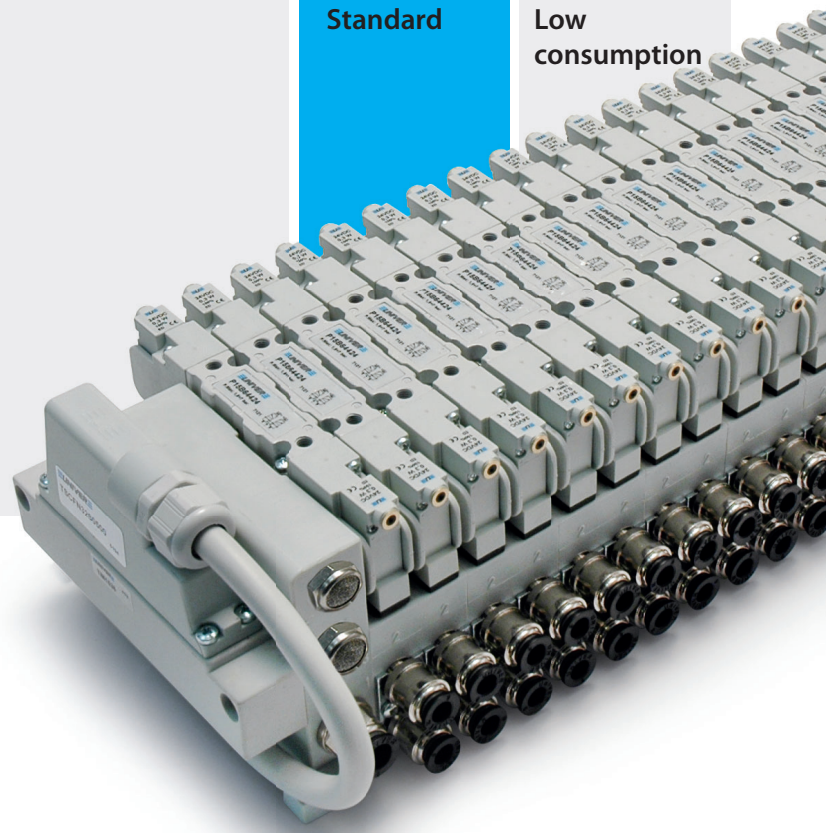
Up to 36 coils control upon request

1 w

Standard

0,3 w

Low consumption



P15F



P15B



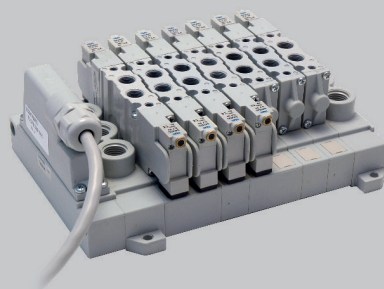
P15F

Threaded ports (G1/8)

Electrical connection with external connector



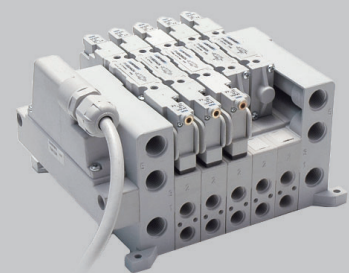
Integrated electrical connection



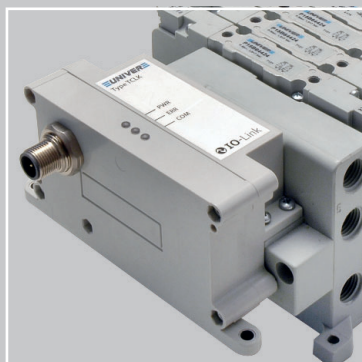
P15B

For sub-base (G1/8 - Tube 4-6-8)

Integrated electrical connection



Available with IO-Link connection



CANopen

DeviceNet

PROFINET

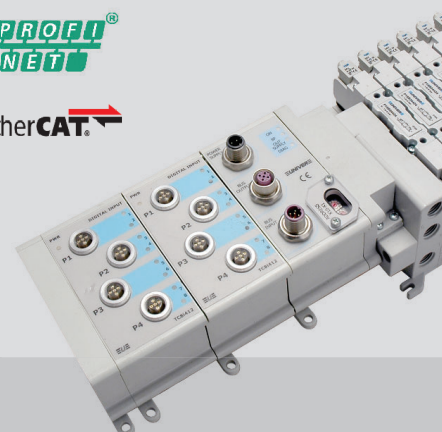
PROFIBUS

EtherNet/IP

EtherCAT

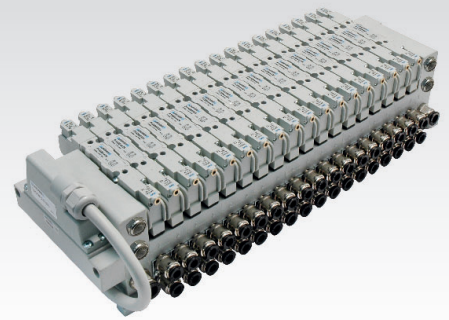
TC Series

Connection to modular serial communication system



CHARACTERISTICS

Ambient temperature	-5 ÷ 50 °C
Fluid	10 µm filtered air, with or without lubrication
Commutation system	spool
Max pressure	7 bar (electrical control) 10 bar (pneumatic control)
Connections	G1/8 (P15F) - G1/8 - tube Ø 4-6-8 (P15B)
Nominal flow rate (NI/min)	800 (5/2) 720 (5/3) 720 (3/2+3/2)
Valve body	zamak
Seals	NBR
Spool	aluminium
Electropilot	B10 (0,3W) - B11 (1 W)
Voltage	24 V DC (± 10%)
Power consumption	B10 = 0,3 W, speed -up 1,3 W (25 ms) B11 = 1 W
Protection degree	IP65
Manual override	recessed button - 1 position



CODIFICATION KEY

P	1	5	F	2	4	4	2	4		
	1	2	3	4	5	6	7			

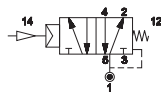
1 Series P15F = Threaded body P15B = Body for sub-base P15D = Threaded body 15 mm connector	2 Type 2 = 5/2 6 = 3/2+3/2 NC-NC 3 = 5/3 c.c. 7 = 3/2+3/2 NC-NO 4 = 5/3 o.c. 8 = 3/2+3/2 NO-NO 5 = 5/3 p.c.	3 Control 14 3 = Pneumatic amplified 4 = Electrical amplified 90° (0,3W) 6 = Electrical amplified 90° (1W)	4 Return 12 0 = Pneumomechanical spring 1 = Mechanical spring 3 = Pneumatic amplified 4 = Electrical amplified 90° (0,3W) 6 = Electrical amplified 90° (1W)
5 Voltage 24 = 24 V DC	6 Option D = External pilot supply on valve body (P15 = M5)	7 ATEX option X = Atex (upon request)	

c.c. = closed centres o.c. = open centres p.c. = pressurized centres

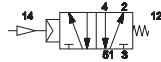
See ATEX Catalogue for types and versions

Pneumatic impulse - Threaded connections G1/8

Single impulse

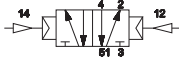


P15F230

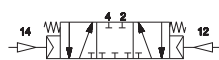


P15F231

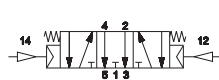
Double impulse



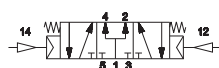
P15F233



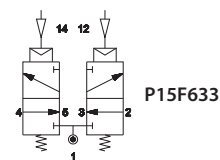
P15F333



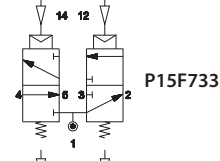
P15F433



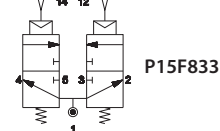
P15F533



P15F633



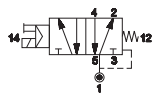
P15F733



P15F833

Electrical impulse - Threaded connections G1/8

■ Single impulse



P15F24024 0,3 W
P15F26024 1 W



P15F24124 0,3 W
P15F26124 1 W

■ B10



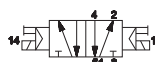
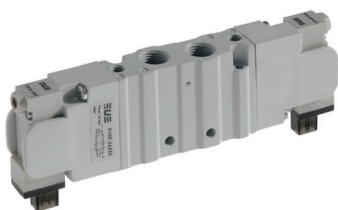
Low power consumption 0,3 W

■ B11

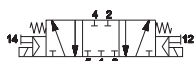


Standard 1 W

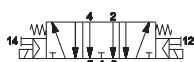
■ Double impulse



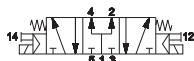
P15F24424 0,3 W
P15F26624 1 W



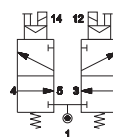
P15F34424 0,3 W
P15F36624 1 W



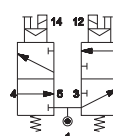
P15F44424 0,3 W
P15F46624 1 W



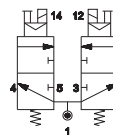
P15F54424 0,3 W
P15F56624 1 W



P15F64424 0,3 W
P15F66624 1 W



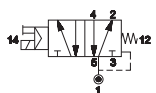
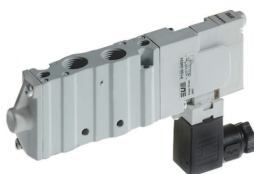
P15F74424 0,3 W
P15F76624 1 W



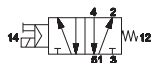
P15F84424 0,3 W
P15F86624 1 W

Electrical impulse - Threaded connections G1/8 - 15 mm connector

■ Single impulse

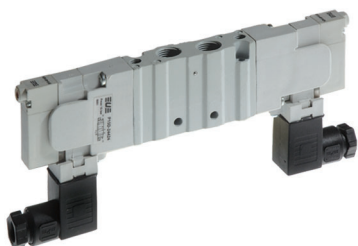


P15D24024 0,3 W
P15D26024 1 W

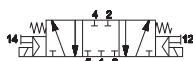


P15D24124 0,3 W
P15D26124 1 W

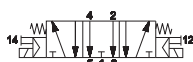
■ Double impulse



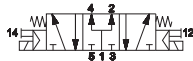
P15D24424 0,3 W
P15D26624 1 W



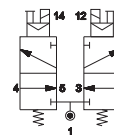
P15D34424 0,3 W
P15D36624 1 W



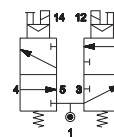
P15D44424 0,3 W
P15D46624 1 W



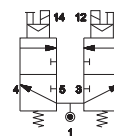
P15D54424 0,3 W
P15D56624 1 W



P15D64424 0,3 W
P15D66624 1 W



P15D74424 0,3 W
P15D76624 1 W



P15D84424 0,3 W
P15D86624 1 W

Integrated electrical connection - Threaded connections G1/8

3

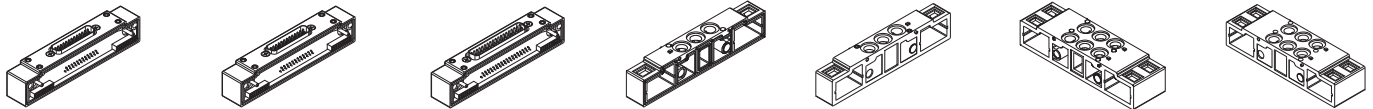


Configuration 25p conn.
max 12 bistable (TIM1524)
max 6 bistable + 12 monostable (TIM151806)

Configuration 37p conn.
max 16 bistable (TIM1536)

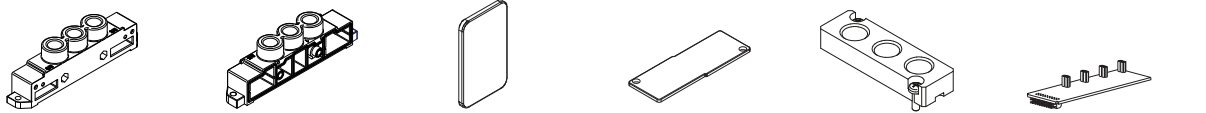
Configuration 37p conn. (upon request)
max 18 bistable
max 24 monostable
max 8 bistable + 16 monostable

TIM1524 TIM151806 TIM1536 P15SF100 P15SF110 P15SF200 P15SF210



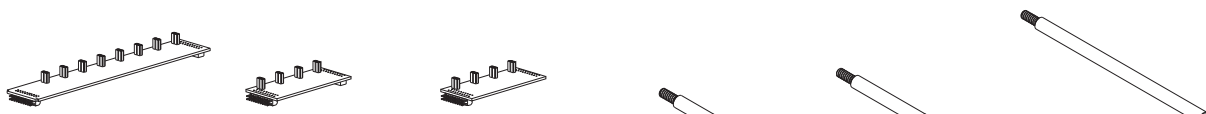
male connection module 25 poles 12+12 coils type sub-D	male connection module 25 poles 18 coils, side 14 6 coils, side 12 type sub-D	male connection module 37 poles 16+16 coils type sub-D	sub-base 1 place	sub-base 1 place 1-3-5 closed	sub-base 2 places	sub-base 2 places 1-3-5 closed
---	---	---	------------------	----------------------------------	-------------------	-----------------------------------

P15SF500 P15SF505 P15SF550 P15SF560 P15SF570 P15SS..M**



left supply plate G1/4 for TIM module	right supply plate G1/4	pressure separator	closing plate for unused valve place	intermediate supply plate for threaded version	male bus connection card, ** = side 14 or 12 .. = 04, 06, 08 places
--	-------------------------	--------------------	---	---	---

P15SS08MF P15SS**04MFP P15SS**04MP P15STR01 P15STR02 P15STR05**



male/female bus connection card ** = side 14 or 12 8 places	male/female bus connection card extension ** = side 14 o 12 4 places	bus card extension ** = side 14 o 12 4 places	modular tie-rods 1 valve place	modular tie-rods 2 valve places	modular tie-rods 5 valve places
--	--	---	-----------------------------------	------------------------------------	------------------------------------

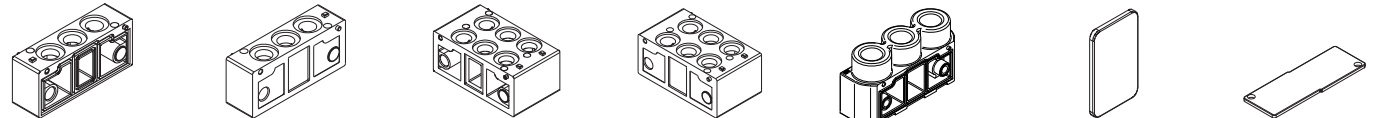
AZ4-SN004A
No. 100 nuts M4
for tie-rods

AZ4-VN0414
No. 100 screws M4x14
for tie-rods

Electrical connection with external connector

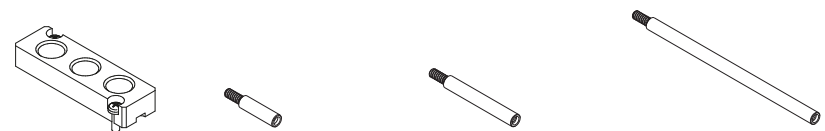


P15SF300 P15SF310 P15SF400 P15SF410 P15SF515 P15SF550 P15SF560



sub-base 1 place	sub-base 1 place 1-3-5 closed	sub-base 2 places	sub-base 2 places 1-3-5 closed	right/left supply plate G1/4	pressure separator	closing plate for unused valve place
------------------	----------------------------------	-------------------	-----------------------------------	---------------------------------	--------------------	---

P15SF570 P15STR01 P15STR02 P15STR05



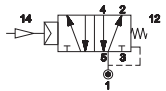
intermediate supply plate for threaded version	modular tie-rods 1 valve place	modular tie-rods 2 valve places	modular tie-rods 5 valve places
---	-----------------------------------	------------------------------------	------------------------------------

AZ4-SN004A
No. 100 nuts M4
for tie-rods

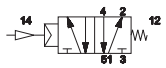
AZ4-VN0414
No. 100 screws M4x14
for tie-rods

Pneumatic impulse - Body for sub-base mounting

Single impulse

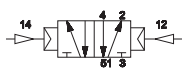


P15B230

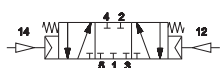


P15B231

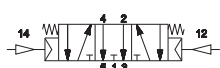
Double impulse



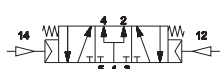
P15B233



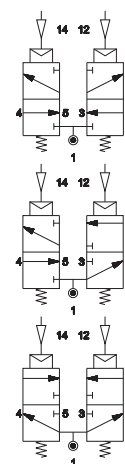
P15B333



P15B433



P15B533



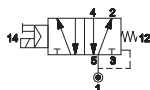
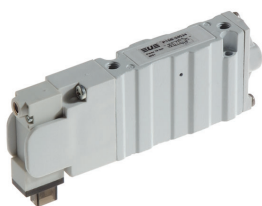
P15B633

P15B733

P15B833

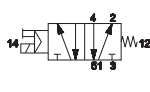
Electrical impulse - Body for sub-base mounting

Single impulse



P15B24024 0,3 W

P15B26024 1 W



P15B24124 0,3 W

P15B26124 1 W

B10



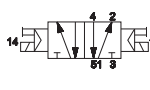
Low power consumption 0,3 W

B11



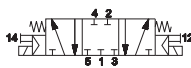
Standard 1 W

Double impulse



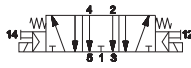
P15B24424 0,3 W

P15B26624 1 W



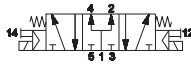
P15B34424 0,3 W

P15B36624 1 W



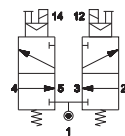
P15B44424 0,3 W

P15B46624 1 W



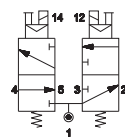
P15B54424 0,3 W

P15B56624 1 W



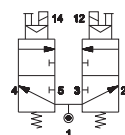
P15B64424 0,3 W

P15B66624 1 W



P15B74424 0,3 W

P15B76624 1 W



P15B84424 0,3 W

P15B86624 1 W

Integrated electrical connection - Body for sub-base mounting



Configuration 25p conn.
max 12 bistable (TIM1524)
max 6 bistable + 12 monostable (TIM151806)

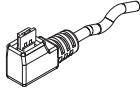
Configuration 37p conn.
max 16 bistable (TIM1536)

Configuration 37p conn. (upon request)
max 18 bistable
max 24 monostable
max 8 bistable + 16 monostable

TIM1524	TIM151806	TIM1536	P15SB100	P15SB110	P15SB200	P15SB210
male connection module 25 poles 12+12 coils type sub-D	male connection module 25 poles 18 coils side 14 6 coils side 12 type sub-D	male connection module 37 poles 16+16 coils type sub-D	sub-base 1 place side outlets G1/8	sub-base 1 place side outlets G1/8 1-3-5 closed	sub-base 2 places side outlets G1/8	sub-base 2 places side outlets G1/8 1-3-5 closed
P15SB300	P15SB310	P15SB400	P15SB410	P15SB500	P15SB505	P15SB550
sub-base 1 place side outlets for push-in fittings	sub-base 1 place side outlets for push-in fittings 1-3-5 closed	sub-base 2 places side outlets for push-in fittings	sub-base 2 places side outlets for push-in fittings 1-3-5 closed	supply plate G1/4 for TIM module	right supply plate G1/4	pressure separator
P15SB560	P15SB570	P15SS**..M	P15SS**08MF	P15SS**04MFP	P15SS**04MP	
closing plate for unused valve place	intermediate supply plate for sub-base	male bus connection card ** = side 14 or 12 .. = 04, 06, 08 places	male/female bus connection card ** = side 14 or 12 8 places	male/female bus connection card extension ** = side 14 or 12 4 places	bus card connection extension ** = side 14 or 12 4 places	
P15STR01	P15STR02	P15STR05	GZR-V10004/06/08	AZ4-SN004A No. 100 nuts M4 for tie-rods	AZ4-VN0414 No. 100 screws M4x14 for tie-rods	
modular tie-rods 1 valve place	modular tie-rods 2 valve places	modular tie-rods 5 valve places	straight fitting GZR-V10004 = tube Ø4 mm GZR-V10006 = tube Ø6 mm GZR-V10008 = tube Ø8 mm			

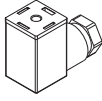
Electrical connections

D-535U40300
D-535U40500



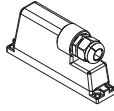
single connector
with cable 3-5 m

AM-5109



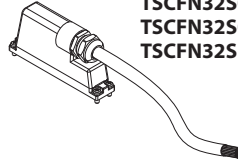
15 mm connector

TSCFN24S000
TSCFN36S000



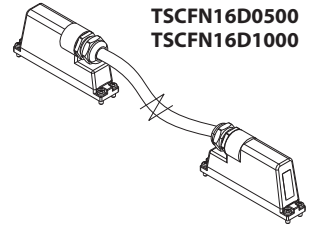
female connector
25/37 poles, type sub-D, no cable
M3x8 fixing screws

TSCFN24S0300
TSCFN24S0500
TSCFN24S1000
TSCFN32S0300
TSCFN32S0500
TSCFN32S1000



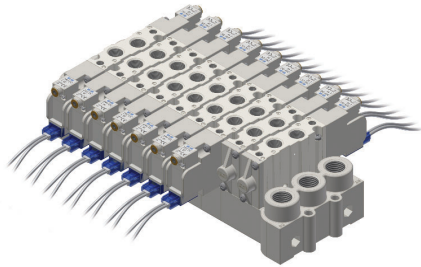
female connector
25/37 poles, type sub-D
with cable 3-5-10 m
M3x8 fixing screws

TSCFN16D0300
TSCFN16D0500
TSCFN16D1000

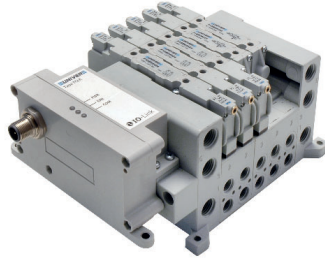


sub-D male/female flying connector
prewired for 16 coils with cable Ø 8 mm
(3-5-10 m length) suitable for dynamic laying
M3x8 fixing screws

■ In-line connections

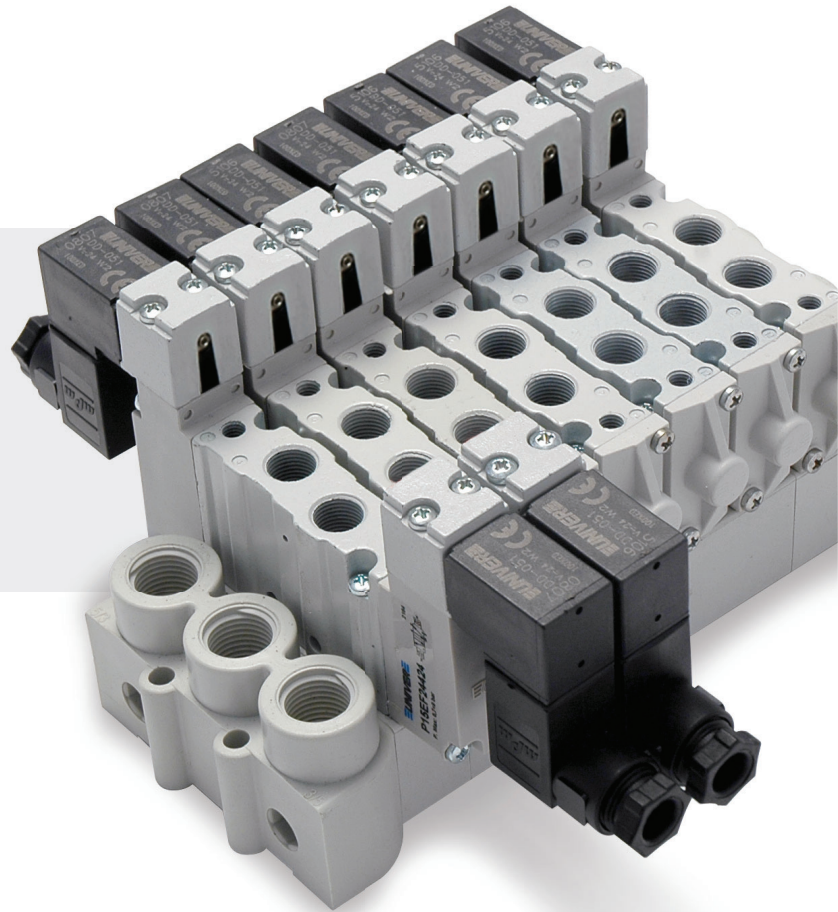


■ IO-Link connection



■ TC series Serial Communication System





HIGH FLOW RATE

Flow rate higher than **800 NI/min**

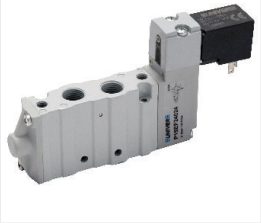
REDUCED DIMENSIONS

Body width 15 mm

COMPLETE SOLUTION

Versions available 5/2 - 5/3 - 3/2+3/2

P15EF

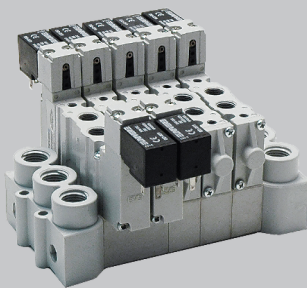


P15EB



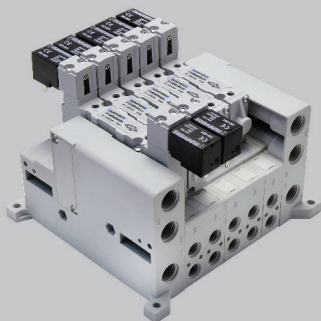
P15EF

Threaded ports (G1/8)

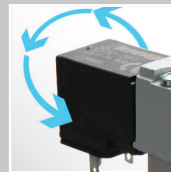


P15EB

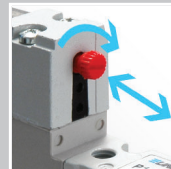
For sub-base (G1/8 - Tube 4-6-8)



15 mm Electropilot - A series
UNIVER Original



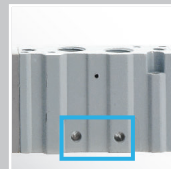
Interchangeable coil - U05 type
90° x 90° revolvable
(12 - 24 V DC, 24 - 48 - 110 - 230 V AC)



Manual override (upon request)
Monostable + 2 positions



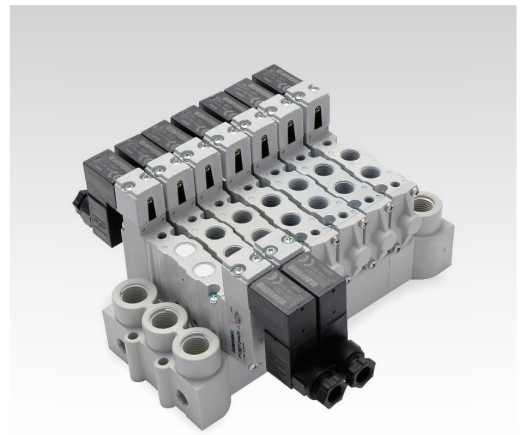
Sub-base mounting
Easy installation by means of 2 screws



Single mounting
Side holes on valve body

CHARACTERISTICS

Ambient temperature	-5 ÷ 50 °C
Fluid	10 µm filtered air, with or without lubrication
Commutation system	spool
Max pressure	9 bar
Connections	G1/8
Nominal flow rate (NI/min)	800 (5/2) 720 (5/3) 720 (3/2+3/2)
Valve body	zamak
Seals	NBR
Spool	aluminium
Electropilot	A series (15 mm)
Coil	U05 series
Voltage	12 V DC - 24 V DC - 24 V AC - 48 V AC - 110 V AC - 230 V AC
Power consumption	2 W (DC) 2,3 VA (AC)
Protection degree	IP65
Manual override	impulse screw - 1-2 positions



CODIFICATION KEY

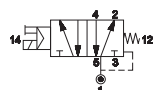
P	1	5	E	F	2	5	5	2	4	
	1		2	3	4	5	6			

1 Series P15EF = COMPACT Valves - Threaded body G1/8 A series electropilot (15 mm)	2 Type 2 = 5/2 3 = 5/3 c.c. 4 = 5/3 o.c. 5 = 5/3 p.c.	3 Control 14 5 = Electrical amplified 15 mm
4 Return 12 0 = Pneumomechanical spring 1 = Mechanical spring 5 = Electrical amplified 15 mm	5 Voltage 12 = 12 V DC 48 = 48 V AC 24 = 24 V DC 11 = 110 V AC 34 = 24 V AC 23 = 230 V AC	6 Option C = 2-position manual override (upon request) D = External pilot supply

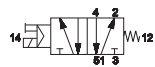
c.c. = closed centres o.c. = open centres p.c. = pressurized centres

Electrical impulse - Threaded connection G1/8

Single impulse

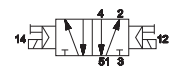
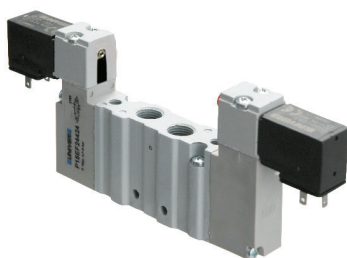


P15EF250**

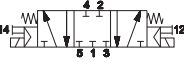


P15EF251**

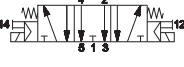
Double impulse



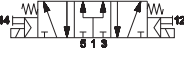
P15EF255**



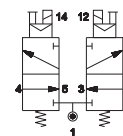
P15EF355**



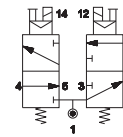
P15EF455**



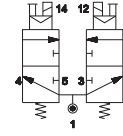
P15EF555**



P15EF655**



P15EF755**



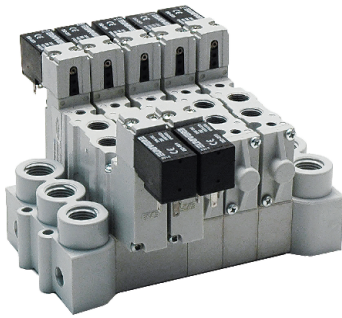
P15EF855**

** = Voltage 12 V DC - 24 V DC - 24 V AC - 48 V AC - 110 V AC - 230 V AC (Example: P15EF25024)

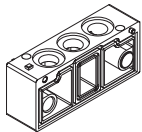
Solenoid valves are supplied with coils, without connectors

Electrical connection with external connector

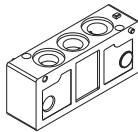
3



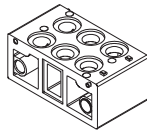
P15SF300 P15SF310 P15SF400 P15SF410 P15SF515 P15SF550 P15SF560



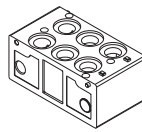
sub-base 1 place



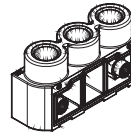
sub-base 1 place
1-3-5 closed



sub-base 2 places



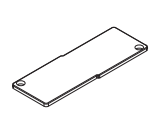
sub-base 2 places
1-3-5 closed



right/left supply plate
G1/4

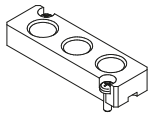


pressure separator



closing plate for
unused valve place

P15SF570 P15STR01 P15STR02 P15STR05



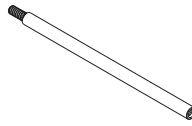
intermediate supply plate
for threaded version



modular tie-rods
1 valve place



modular tie-rods
2 valve places



modular tie-rods
5 valve places

AZ4-SN004A

No. 100 nuts M4 for tie-rods

AZ4-VN0414

No. 100 screws M4x14 for tie-rods

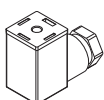
Pre-assembled sub-base



Part No.	Positions
P15SF499-02	2
P15SF499-03	3
P15SF499-04	4
P15SF499-05	5
P15SF499-06	6
P15SF499-07	7
P15SF499-08	8
P15SF499-09	9
P15SF499-10	10

Pre-assembled sub-bases include seals and screws for valve assembly

Electrical connections



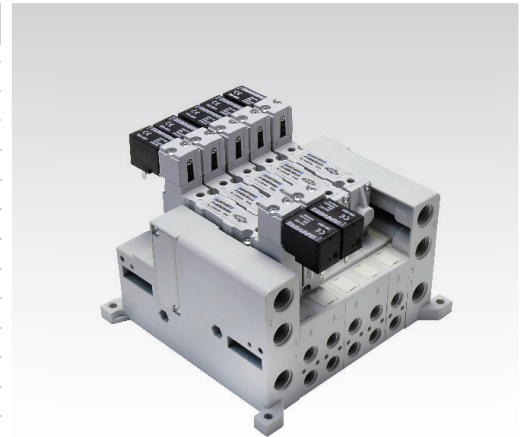
AM-5109

15 mm connector

3
76

CHARACTERISTICS

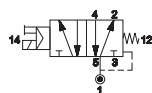
Ambient temperature	-5 ÷ 50 °C
Fluid	10 µm filtered air, with or without lubrication
Commutation system	spool
Max pressure	9 bar
Connections	G1/8
Nominal flow rate (NI/min)	800 (5/2) 720 (5/3) 720 (3/2+3/2)
Valve body	zamak
Seals	NBR
Spool	aluminium
Electropilot	A series (15 mm)
Coil	U05 series
Voltage	12 V DC - 24 V DC - 24 V AC - 48 V AC - 110 V AC - 230 V AC
Power consumption	2 W (DC) 2,3 VA (AC)
Protection degree	IP65
Manual override	impulse screw - 1-2 positions


CODIFICATION KEY

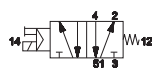
P	1	5	E	B	2	5	5	2	4	
	1				2	3	4	5	6	

1 Series	2 Type	3 Control 14
P15EB = COMPACT Valves for sub-base mounting A series electropilot (15 mm)	2 = 5/2 3 = 5/3 c.c. 4 = 5/3 o.c. 5 = 5/3 p.c.	5 = Electrical amplified 15 mm
4 Return 12	5 Voltage	6 Variant
0 = Pneumomechanical spring 1 = Mechanical spring 5 = Electrical amplified 15 mm	12 = 12 V DC 48 = 48 V AC 24 = 24 V DC 11 = 110 V AC 34 = 24 V AC 23 = 230 V AC	C = 2-position manual override (upon request) D = External pilot supply

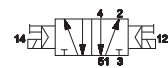
c.c. = closed centres o.c. = open centres p.c. = pressurized centres

Electrical impulse - Body for sub-base mounting - 15 mm connector
Single impulse


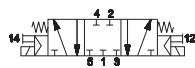
P15EB250**



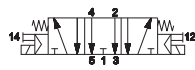
P15EB251**

Double impulse


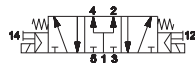
P15EB255**



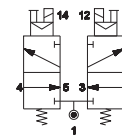
P15EB355**



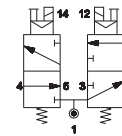
P15EB455**



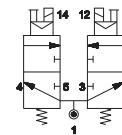
P15EB555**



P15EB655**



P15EB755**



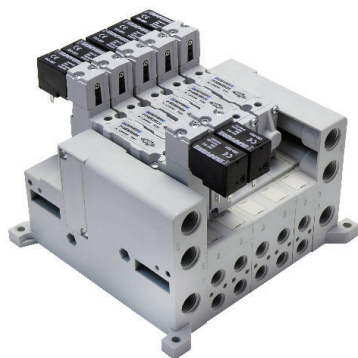
P15EB855**

** = Voltage 12 V DC - 24 V DC - 24 V AC - 48 V AC - 110 V AC - 230 V AC (Example: P15EB25024)

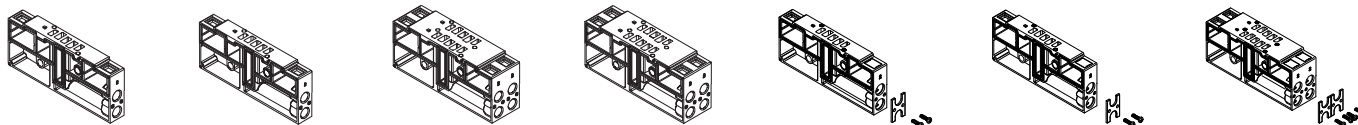
Solenoid valves are supplied with coils, without connectors

Electrical connection with external connector

3

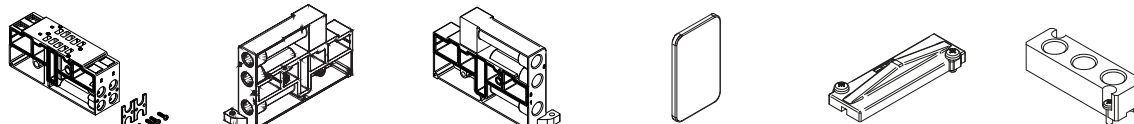


P15SB100 P15SB110 P15SB200 P15SB210 P15SB300 P15SB310 P15SB400



sub-base 1 place side outlets G1/8 sub-base 1 place side outlets G1/8 1-3-5 closed sub-base 2 places side outlets G1/8 sub-base 2 places side outlets G1/8 1-3-5 closed sub-base 1 place side outlets for GZR push-in fittings sub-base 1 place side outlets for GZR push-in fittings 1-3-5 closed sub-base 2 places side outlets for GZR push-in fittings

P15SB410 P15SB502 P15SB505 P15SB550 P15SB560 P15SB570



sub-base 2 places side outlets for GZR push-in fittings 1-3-5 closed left supply plate G1/4 right supply plate G1/4 pressure separator closing plate for unused valve place intermediate supply plate for sub-base

P15STR01 P15STR02 P15STR05 GZR-V10004/06/08



modular tie-rods 1 valve place modular tie-rods 2 valve places modular tie-rods 5 valve places straight fitting
 GZR-V10004 = tube Ø4 mm
 GZR-V10006 = tube Ø6 mm
 GZR-V10008 = tube Ø8 mm

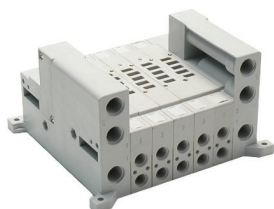
AZ4-SN004A

No. 100 nuts M4 for tie-rods

AZ4-VN0414

No. 100 screws M4x14 for tie-rods

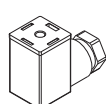
Pre-assembled sub-base



Part No.	Positions
P15SB499-02	2
P15SB499-03	3
P15SB499-04	4
P15SB499-05	5
P15SB499-06	6
P15SB499-07	7
P15SB499-08	8
P15SB499-09	9
P15SB499-10	10

Pre-assembled sub-bases include seals and screws for valve assembly

Electrical connections



AM-5109

15 mm connector

HIGH FLOW RATE

800 NI/min (G1/8) 1700 NI/min (G1/4)

REDUCED DIMENSIONS

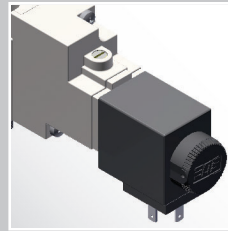
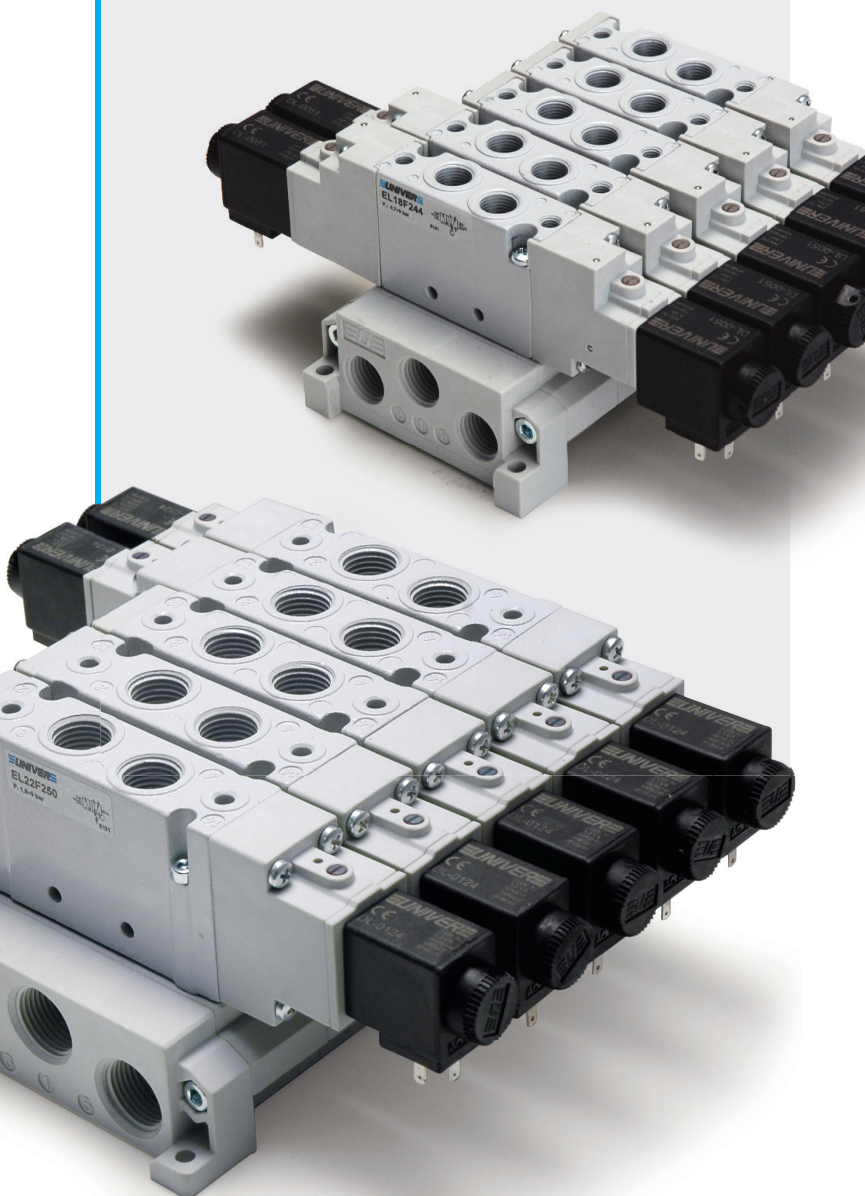
18 mm (G1/8) 22 mm (G1/4)

COMPLETE SOLUTION

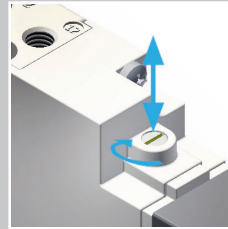
5/2 - 5/3 - 3/2 + 3/2

STRONG

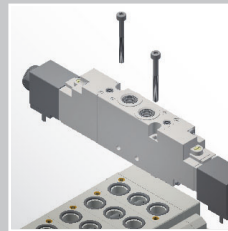
Metallic body



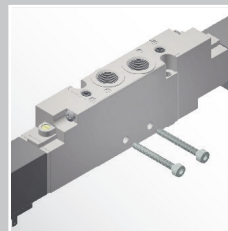
Interchangeable U06 coil
12 - 24 V DC
24 - 110 - 220 V AC



Manual override (standard)
1/2 position impulse



Sub-base mounting
Easy installation by means of 2 screws



Individual mounting
Side holes on valve body



Traditional UNIVER technology
The dynamic spool guarantees a long life and reliability



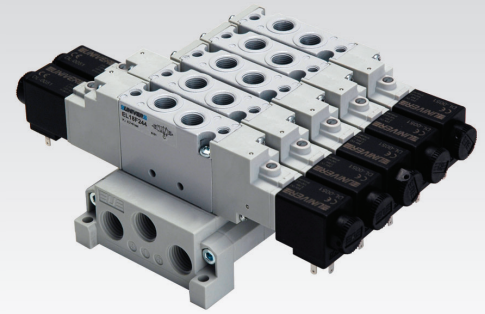
Modular sub-base in technopolymer



Aluminium sub-base

CHARACTERISTICS

Ambient temperature	-5 ÷ +50 °C
Fluid	filtered air 10 µm, with or without lubrication
Commutation system	spool
Max pressure	8 bar (electrical override) 10 bar (pneumatic override)
Connections	G1/8
Nominal flow rate (NI/min)	800 (5/2) 720 (5/3) 720 (3/2+3/2)
Valve body	zamak
Seals	NBR
Electropilot/Coil	series U06/DL
Spool	aluminium
Voltage	12 V DC - 24 V DC - 24 V AC - 110 V AC - 230 V AC
Power consumption	2,5 W 5 VA
Protection degree	IP65
Manual override	impulse 1-2 positions



CODIFICATION KEY

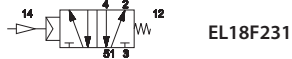
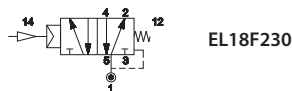
E	L	1	8	F	2	5	0		
		1			2	3	4	5	6

<p>1 Series EL18F = ESSENTIAL Valves 18 mm - G1/8</p>	<p>2 Type 2 = 5/2 6 = 3/2+3/2 NC-NC 3 = 5/3 c.c. 7 = 3/2+3/2 NC-NO 4 = 5/3 o.c. 8 = 3/2+3/2 NO-NO 5 = 5/3 p.c.</p>	<p>3 Control 14 3 = Pneumatic amplified 5 = Electrical amplified DC/AC</p>
<p>4 Return 12 0 = Pneumomechanical spring 1 = Mechanical spring 3 = Pneumatic amplified 5 = Electrical amplified DC/AC</p>	<p>5 Option D = External pilot supply</p>	<p>6 ATEX option X = Atex (upon request)</p> <p>See ATEX Catalogue for types and versions</p>

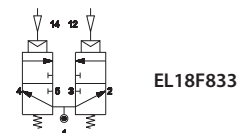
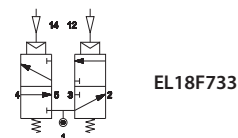
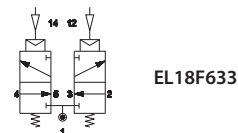
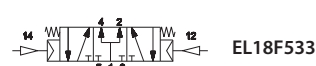
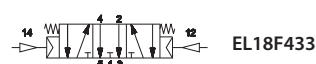
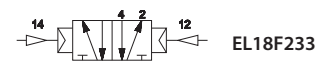
c.c. = closed centers o.c. = open centers p.c. = pressurized centers

Pneumatic impulse

■ Single impulse

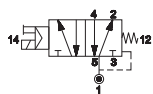


■ Double impulse

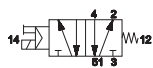


Electrical impulse

■ Single impulse

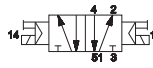


EL18F250

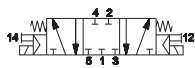


EL18F251

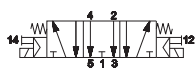
■ Double impulse



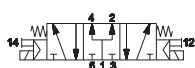
EL18F255



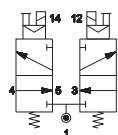
EL18F355



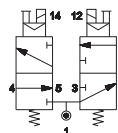
EL18F455



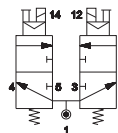
EL18F555



EL18F655

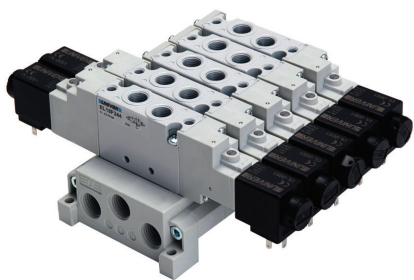


EL18F755

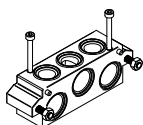


EL18F855

Modular sub-base in technopolymer

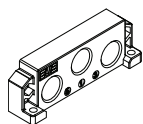


EL18SF300



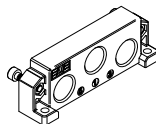
Sub-base 1 place
(screw and seals are included)

EL18SF515



Left supply plate G1/4

EL18SF516



Right supply plate G1/4
(screws and seals are included)

EL18SF518



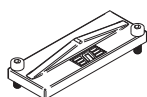
Fixing spring for DIN rail
(screws are included)

EL18SF550



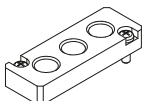
Pressure separator

EL18SF560



Closing plate for unused
valve place (screws are included)

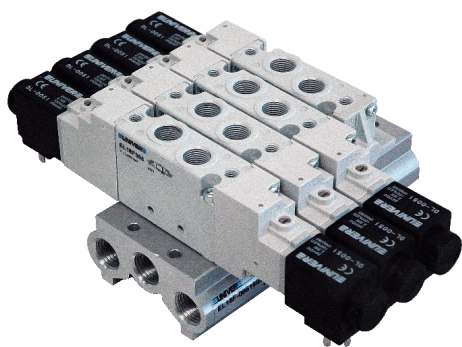
EL18SF570



Intermediate supply plate
(screws are included)

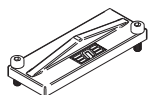
Aluminium sub-base

3



Part No.	No. positions
EL18SF900-02	2
EL18SF900-03	3
EL18SF900-04	4
EL18SF900-05	5
EL18SF900-06	6
EL18SF900-07	7
EL18SF900-08	8
EL18SF900-09	9
EL18SF900-10	10

EL18SF560



Closing plate for unused valve place (screws are included)

The sub-base includes gaskets and screws for mounting valves

Coil and connector

■ Coil



- DL-0050 12 V DC 2,5 W
- DL-0051 24 V DC 2,5 W
- DL-0106 24 V AC 50/60 Hz 5 VA
- DL-0108 110 V AC 50/60 Hz 5 VA
- DL-0124 230 V AC 50/60 Hz 5 VA

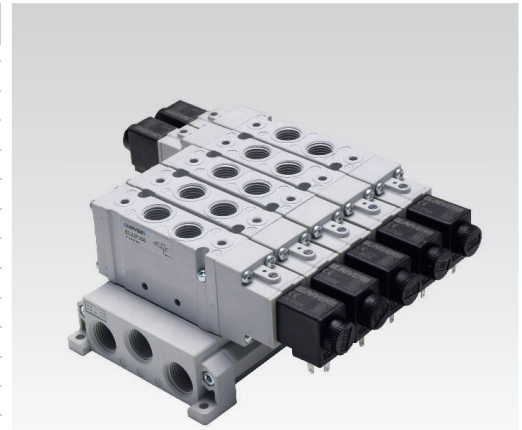
■ Connector



AM-5109

CHARACTERISTICS

Ambient temperature	-5 ÷ +50 °C
Fluid	filtered air 10 µm, with or without lubrication
Commutation system	spool
Max pressure	8 bar (electrical control) 10 bar (pneumatic control)
Connection	G1/4
Nominal flow rate (NI/min)	1700 (5/2) 1450 (5/3) 1450 (3/2+3/2)
Valve body	aluminium
Seals	NBR
Electropilot/Coil	series U06/DL
Spool	aluminium
Voltage	12 V DC - 24 V DC - 24 V AC - 110 V AC - 230 V AC
Power consumption	2,5 W 5 VA
Protection degree	IP65
Manual override	impulse 1-2 positions



CODIFICATION KEY

E	L	2	2	F	2	5	0		
		1	2	3	4	5	6		

1 Series EL22F = ESSENTIAL Valves 22 mm - G1/4	2 Type 2 = 5/2 6 = 3/2+3/2 NC-NC 3 = 5/3 c.c. 7 = 3/2+3/2 NC-NO 4 = 5/3 o.c. 8 = 3/2+3/2 NO-NO 5 = 5/3 p.c.	3 Control 14 3 = Pneumatic amplified 5 = Electrical amplified DC/AC
--	---	--

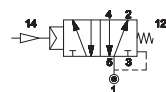
4 Return 12 0 = Pneumomechanical spring 1 = Mechanical spring 3 = Pneumatic amplified 5 = Electrical amplified DC/AC	5 Option D = External pilot supply	6 ATEX option X = Atex (upon request)
---	--	---

See ATEX Catalogue for types and versions

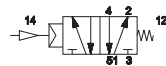
c.c. = closed centers o.c. = open centers p.c. = pressurized centers

Pneumatic impulse

■ Single impulse



EL22F230

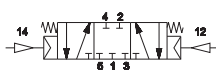


EL22F231

■ Double impulse



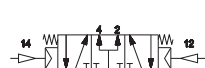
EL22F233



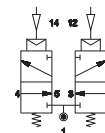
EL22F333



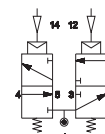
EL22F433



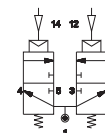
EL22F533



EL22F633



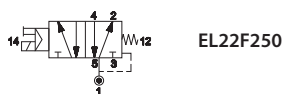
EL22F733



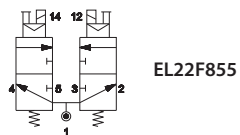
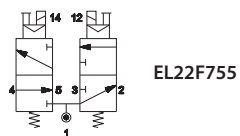
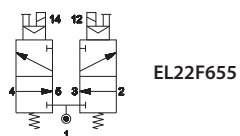
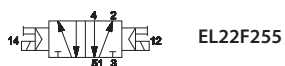
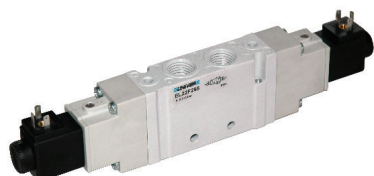
EL22F833

Electrical impulse

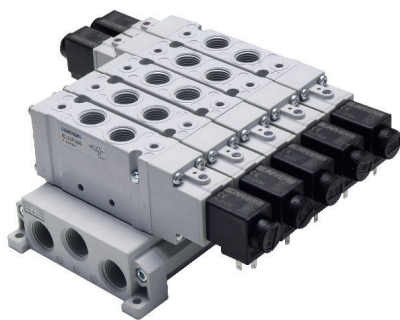
■ Single impulse



■ Double impulse



Modular sub-base in technopolymer



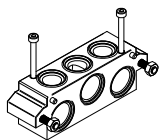
EL22SF300

EL22SF515

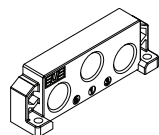
EL22SF516

EL18SF518

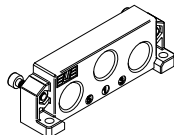
EL22SF550



Sub-base 1 place
(screws and seals are included)



Left supply plate G1/4



Right supply plate G1/4
(screws and seals are included)



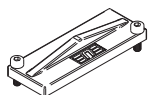
Fixing spring for DIN rail
(screws are included)



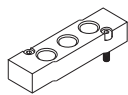
Pressure separator

EL22SF560

EL22SF570

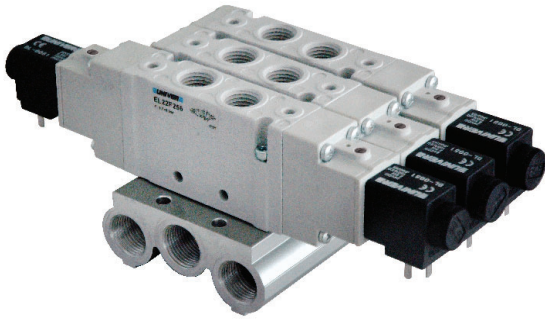


Closing plate for unused
valve place (screws are
included)



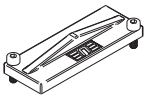
Intermediate supply plate
(screws are included)

Aluminium sub-base



Part No.	No. positions
EL22SF900-02	2
EL22SF900-03	3
EL22SF900-04	4
EL22SF900-05	5
EL22SF900-06	6
EL22SF900-07	7
EL22SF900-08	8
EL22SF900-09	9
EL22SF900-10	10

EL22SF560

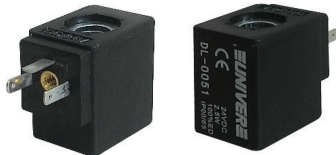


Closing plate for unused valve place (screws are included)

The sub-base includes gaskets and screws for mounting valves

Coil and connector

■ Coil



- DL-0050 12 V DC 2,5 W
- DL-0051 24 V DC 2,5 W
- DL-0106 24 V AC 50/60 Hz 5 VA
- DL-0108 110 V AC 50/60 Hz 5 VA
- DL-0124 230 V AC 50/60 Hz 5 VA

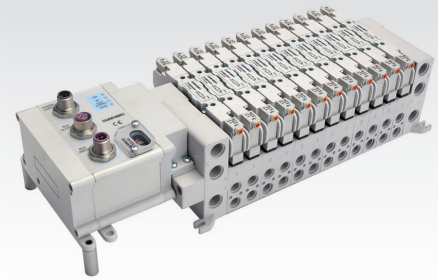
■ Connector



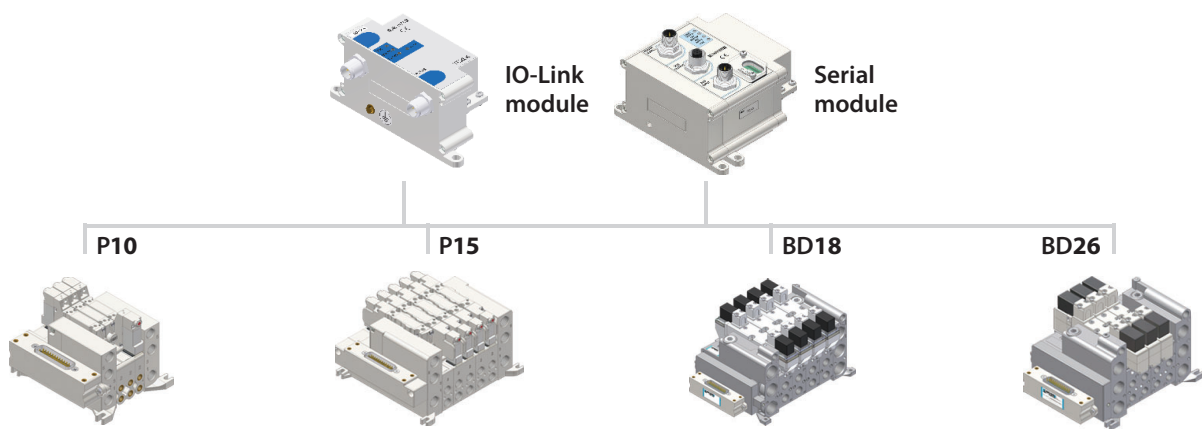
AM-5109


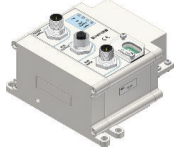
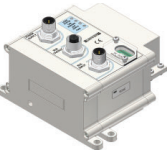

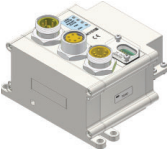


CHARACTERISTICS

Controlled devices	Manifolds, Digital input M12/M8, Output M12
Handling capacity	Max 64 inputs + 64 outputs (PROFIBUS-DP, CANopen, DeviceNet)
	Max 64 inputs + 88 outputs (PROFINET, EtherNet/IP, EtherCAT)
Integrated configuration	Max 24 coils (IO-Link)
	BD series 18 - 26 mm
Distributed configuration	P10 - P15 series (COMPACT)
	Remote expansion modules for valve manifolds with sub-D 25 plug-in (NO IO-Link)
Protocols	IO-Link, CANopen, DeviceNet, PROFINET, PROFIBUS-DP, EtherNet/IP, EtherCAT



Communication systems



<p>■ IO-Link</p>  <table border="1"> <tr> <td>Part No.</td> <td>TCXLKA - TCXLKB</td> </tr> <tr> <td>Auxiliary power supply and Fieldbus</td> <td>1 x M12 - 5 pins male (port class B)</td> </tr> <tr> <td>Diagnostics</td> <td>Optical, Primary, Extended</td> </tr> <tr> <td>Capacity max I/O</td> <td>24 coils</td> </tr> </table>	Part No.	TCXLKA - TCXLKB	Auxiliary power supply and Fieldbus	1 x M12 - 5 pins male (port class B)	Diagnostics	Optical, Primary, Extended	Capacity max I/O	24 coils	<p>■ PROFIBUS-DP</p>  <table border="1"> <tr> <td>Part No.</td> <td>TCXP</td> </tr> <tr> <td>Auxiliary power supply</td> <td>1 x M12 - 4 pins male</td> </tr> <tr> <td>Fieldbus</td> <td>1 x M12 - 4 pins male B code</td> </tr> <tr> <td>Connectors</td> <td>1 x M12 - 4 pins female B code</td> </tr> <tr> <td>Diagnostics</td> <td>Optical, Primary, Extended</td> </tr> <tr> <td>Capacity max I/O</td> <td>64 In - 40 Out 24 coils</td> </tr> </table>	Part No.	TCXP	Auxiliary power supply	1 x M12 - 4 pins male	Fieldbus	1 x M12 - 4 pins male B code	Connectors	1 x M12 - 4 pins female B code	Diagnostics	Optical, Primary, Extended	Capacity max I/O	64 In - 40 Out 24 coils						
Part No.	TCXLKA - TCXLKB																										
Auxiliary power supply and Fieldbus	1 x M12 - 5 pins male (port class B)																										
Diagnostics	Optical, Primary, Extended																										
Capacity max I/O	24 coils																										
Part No.	TCXP																										
Auxiliary power supply	1 x M12 - 4 pins male																										
Fieldbus	1 x M12 - 4 pins male B code																										
Connectors	1 x M12 - 4 pins female B code																										
Diagnostics	Optical, Primary, Extended																										
Capacity max I/O	64 In - 40 Out 24 coils																										
<p>■ CANopen</p>  <table border="1"> <tr> <td>Part No.</td> <td>TCXC</td> </tr> <tr> <td>Auxiliary power supply</td> <td>1 x M12 - 4 pins male</td> </tr> <tr> <td>Fieldbus</td> <td>1 x M12 - 5 pins male</td> </tr> <tr> <td>Connectors</td> <td>1 x M12 - 5 pins female</td> </tr> <tr> <td>Diagnostics</td> <td>Optical, Primary, Extended</td> </tr> <tr> <td>Capacity max I/O</td> <td>64 In - 40 Out 24 coils</td> </tr> <tr> <td>LSS Slave</td> <td>supported</td> </tr> </table>	Part No.	TCXC	Auxiliary power supply	1 x M12 - 4 pins male	Fieldbus	1 x M12 - 5 pins male	Connectors	1 x M12 - 5 pins female	Diagnostics	Optical, Primary, Extended	Capacity max I/O	64 In - 40 Out 24 coils	LSS Slave	supported	<p>■ EtherNet/IP</p>  <table border="1"> <tr> <td>Part No.</td> <td>TCXEN</td> </tr> <tr> <td>Auxiliary power supply</td> <td>1 x M12 - 4 pins male</td> </tr> <tr> <td>Fieldbus</td> <td>2 x M12 - 4 pins female D code</td> </tr> <tr> <td>Connectors</td> <td></td> </tr> <tr> <td>Diagnostics</td> <td>Optical, Primary, Extended</td> </tr> <tr> <td>Capacity max I/O</td> <td>64 In - 64 Out 24 coils</td> </tr> </table>	Part No.	TCXEN	Auxiliary power supply	1 x M12 - 4 pins male	Fieldbus	2 x M12 - 4 pins female D code	Connectors		Diagnostics	Optical, Primary, Extended	Capacity max I/O	64 In - 64 Out 24 coils
Part No.	TCXC																										
Auxiliary power supply	1 x M12 - 4 pins male																										
Fieldbus	1 x M12 - 5 pins male																										
Connectors	1 x M12 - 5 pins female																										
Diagnostics	Optical, Primary, Extended																										
Capacity max I/O	64 In - 40 Out 24 coils																										
LSS Slave	supported																										
Part No.	TCXEN																										
Auxiliary power supply	1 x M12 - 4 pins male																										
Fieldbus	2 x M12 - 4 pins female D code																										
Connectors																											
Diagnostics	Optical, Primary, Extended																										
Capacity max I/O	64 In - 64 Out 24 coils																										
<p>■ DeviceNet</p>  <table border="1"> <tr> <td>Part No.</td> <td>TCXD</td> </tr> <tr> <td>Auxiliary power supply</td> <td>1 x 7/8" - 4 pins male</td> </tr> <tr> <td>Fieldbus</td> <td>1 x 7/8" - 5 pins male</td> </tr> <tr> <td>Connectors</td> <td>1 x 7/8" - 5 pins female</td> </tr> <tr> <td>Diagnostics</td> <td>Optical, Primary, Extended</td> </tr> <tr> <td>Capacity max I/O</td> <td>64 In - 40 Out 24 coils</td> </tr> </table>	Part No.	TCXD	Auxiliary power supply	1 x 7/8" - 4 pins male	Fieldbus	1 x 7/8" - 5 pins male	Connectors	1 x 7/8" - 5 pins female	Diagnostics	Optical, Primary, Extended	Capacity max I/O	64 In - 40 Out 24 coils	<p>■ EtherCAT</p>  <table border="1"> <tr> <td>Part No.</td> <td>TCXEC</td> </tr> <tr> <td>Auxiliary power supply</td> <td>1 x M12 - 4 pins male</td> </tr> <tr> <td>Fieldbus</td> <td>2 x M12 - 4 pins female D code</td> </tr> <tr> <td>Connectors</td> <td></td> </tr> <tr> <td>Diagnostics</td> <td>Optical, Primary, Extended</td> </tr> <tr> <td>Capacity max I/O</td> <td>64 In - 64 Out 24 coils</td> </tr> </table>	Part No.	TCXEC	Auxiliary power supply	1 x M12 - 4 pins male	Fieldbus	2 x M12 - 4 pins female D code	Connectors		Diagnostics	Optical, Primary, Extended	Capacity max I/O	64 In - 64 Out 24 coils		
Part No.	TCXD																										
Auxiliary power supply	1 x 7/8" - 4 pins male																										
Fieldbus	1 x 7/8" - 5 pins male																										
Connectors	1 x 7/8" - 5 pins female																										
Diagnostics	Optical, Primary, Extended																										
Capacity max I/O	64 In - 40 Out 24 coils																										
Part No.	TCXEC																										
Auxiliary power supply	1 x M12 - 4 pins male																										
Fieldbus	2 x M12 - 4 pins female D code																										
Connectors																											
Diagnostics	Optical, Primary, Extended																										
Capacity max I/O	64 In - 64 Out 24 coils																										
<p>■ PROFINET</p>  <table border="1"> <tr> <td>Part No.</td> <td>TCXPN</td> </tr> <tr> <td>Auxiliary power supply</td> <td>1 x M12 - 4 pins male</td> </tr> <tr> <td>Fieldbus</td> <td>2 x M12 - 4 pins female</td> </tr> <tr> <td>Connectors</td> <td>D code</td> </tr> <tr> <td>Diagnostics</td> <td>Optical, Primary, Extended</td> </tr> <tr> <td>Capacity max I/O</td> <td>64 In - 64 Out 24 coils</td> </tr> <tr> <td>FSU</td> <td>supported</td> </tr> </table>	Part No.	TCXPN	Auxiliary power supply	1 x M12 - 4 pins male	Fieldbus	2 x M12 - 4 pins female	Connectors	D code	Diagnostics	Optical, Primary, Extended	Capacity max I/O	64 In - 64 Out 24 coils	FSU	supported													
Part No.	TCXPN																										
Auxiliary power supply	1 x M12 - 4 pins male																										
Fieldbus	2 x M12 - 4 pins female																										
Connectors	D code																										
Diagnostics	Optical, Primary, Extended																										
Capacity max I/O	64 In - 64 Out 24 coils																										
FSU	supported																										

Expansion modules (not available for IO-Link)

<p>TC8I412 8 Digital inputs M12</p>	<p>TC16I812 16 Digital inputs M12</p>	<p>TC8U412 8 Digital outputs M12</p>	<p>TC8I808 8 Digital inputs M8</p>	<p>TCR32ID 16+16 Digital inputs</p>	<p>TCXU578 Auxiliary supply module 7/8"</p>
				<p>TCR32UD 16+16 Digital outputs</p>	

Accessories for serial modules

<p>TZ-F4M12</p> <p>CANopen, ProfiBus, ProfiNet EtherNet/IP, EtherCat IO-Link port class A Power Supply Connector M12 female 4 poles</p>	<p>TZ-F5M12</p> <p>CANopen IO-Link port class A/B Input Bus M12 female 5 poles</p>	<p>TZ-M5M12/T</p> <p>TZ-M5M12 CANopen Output Bus M12 male 5 poles TZ-M5M12T CANopen, Bus terminating connector M12 male 5 poles</p>	<p>TZ-F478</p> <p>DeviceNet Power Supply Connector 7/8 female 4 poles</p>	<p>TZ-F578</p> <p>DeviceNet Input Bus 7/8 female 5 poles</p>
<p>TZ-M578/T</p> <p>TZ-M578 DeviceNet Input Bus 7/8 male 5 poles TZ-M578T DeviceNet Bus terminating connector 7/8 male 5 poles</p>	<p>TZ-F4M12-B</p> <p>ProfiBus Input Bus M12 female 5 poles B-code</p>	<p>TZ-M4M12-B/BT</p> <p>TZ-M4M12-B ProfiBus Output Bus M12 male 4 poles B-code TZ-M4M12-BT ProfiBus Bus terminating connector M12 male 4 poles B-code</p>	<p>TZ-M4M12-D</p> <p>ProfiNet, EtherNet/IP, EtherCat Input/Output Bus M12 male 4 poles D-code</p>	<p>TSCFN16...</p> <p>TSCFN16D0300 Prewired cable, sub-D, 25 poles, 16 signals 3 m TSCFN16D0500 Prewired cable, sub-D 25 poles, 16 signals 5 m TSCFN16D1000 Prewired cable, sub-D 25 poles, 16 signals 10 m</p>

Assembly scheme (excluding IO-Link)

- FieldBus Module
- Auxiliary Module - Inputs 8 x M8
- Auxiliary Module - Inputs 4 x M12
- Auxiliary Module - Outputs 4 x M12
- TCXX end cover included (1 pc)
- TCXX cover screws included (4 pcs.)
- I/O tie-rods included (4 pcs.)
- TFP010 1 mm for valves P10F-P15F (2 pcs.)
TFP060 6 mm for valves BD 18-26 mm (2 pcs.)
TFP178 17,5 mm for valves P10B (2 pcs.)
TFP257 25,7 mm for valves P15B (2 pcs.)
- Support foot for modules
- Adaptor for 18-26 mm VDMA Manifold

MATCHING TABLE - COILS/ELECTROPILOTS - ELECTROPILOTS/SOLENOID VALVES			Electropilots						
			A (U05)	B (U04)	AA (U1)	AA (U3)		AB (U2)	
Coils	U04	10 mm		■					
	U05	15 mm	■						
	U1	22 mm			■				
	U2	30 mm						■	■
	U3	30 mm				■	■		
Solenoid valves	BE	ISO 1 - ISO 2 ISO 3 - ISO 4	■ (a)				■		R
	AE	ISO 1 - ISO 2			■	■			
	BD	ISO 01 26 mm ISO 02 18 mm	■						
	AC-N	Interface NAMUR			■	■			
	CL	G1/8			■	■			
	CM	G1/4			■	■			
	COMPACT 2/4		■						
	G6	G1/8	■	■					
	GL6	sub-base	■						
	G7	G1/8	R		■	■			
	PS	tube Ø 4 tube Ø 6 tube Ø 8		■					
	AC	G1/8 - G1/4			■	■			
		G1/2			R	R		■	
	AF	G1/8			■	■			
		G1/4 - G3/8			■	■		■	
		G1/2 ÷ G1			R	R		■	
	AG	G1 1/2							■
		G1/8			■	■			
G1/4 ÷ G1				R	R		■		
P15E	G1/8	■						■	

■ = Standard R = Upon request (a) = Connector M12

 Available ATEX version upon request
 See ATEX Catalogue for types and versions

10 mm U04 Coils for B series electropilots

■ With integrated 90° upward connector


DE-352 24 V DC 1,2 W
DE-452 24 V DC 1,35 W (with led)
DE-355 24 V DC 0,5 W

Connector:
 D-500
 D-530-...
 D-535-...

■ With in-line connector


DE-552 24 V DC 1,2 W
DE-652 24 V DC 1,35 W (with led)
DE-555 24 V DC 0,5 W

Connector:
 D-500
 D-530-...
 D-535-...

■ With loose cables (length 300 mm)




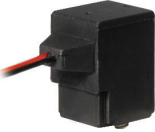


DE-052L030 24 V DC 1,2 W

■ With in-line connector with protecting cover for complete tightness


DE-642I 12 V DC 1,35 W
DE-652I 24 V DC 1,35 W (with led)
DE-655I 24 V DC 0,5 W



Connector:
 D-530C-100
 D-530C-200

15 mm U05 Coils for A series electropilot

<p>■ with integrated 90° upward connector</p>  <p>DD-351 24 V DC Connector: D-500 D-530-... D-535-...</p>	<p>■ with integrated 90° downward connector</p>  <p>DD-151 24 V DC Connector: D-500 D-530-... D-535-...</p>	<p>■ with in-line connector</p>  <p>DD-551 24 V DC Connector: D-500 D-530-... D-535-...</p>
<p>■ with loose cables (300 mm)</p>  <p>DD-051L030 24 V DC 2 W DD-052L030 24 V DC 2,5 W</p>	<p>■ 15 mm - Faston</p>  <p>DD-013 230 V AC 50/60 Hz 3,5 VA DD-040 24 V AC 50/60 Hz 2,3 VA DD-041 12 V DC 2 W DD-042 12 V DC 2,5 W DD-050 48 V AC 50/60 Hz 2,3 VA</p> <p>Connector: AM-5109</p>	<p>DD-051 24 V DC 2 W DD-052 24 V DC 2,5 W DD-060 110 V AC 50/60 Hz 2,3 VA DD-070 230 V AC 50/60 Hz 2,3 VA</p>







Coil U06 15 mm for valves EL18/EL22

■ 15 mm

DL-0050 12 V DC 2,5 W
DL-0051 24 V DC 2,5 W
DL-0106 24 V AC 50/60 Hz 5 VA
DL-0108 110 V AC 50/60 Hz 5 VA
DL-0124 230 V AC 50/60 Hz 5 VA

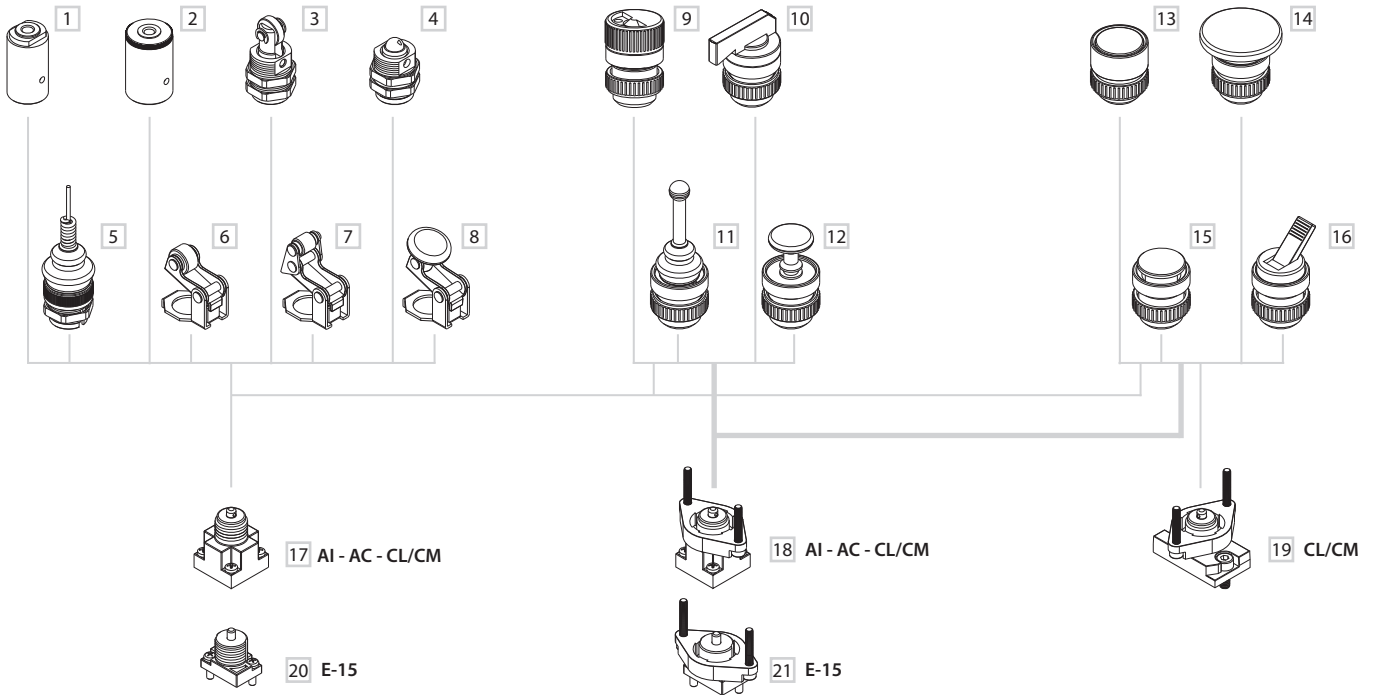
U1 - U2 - U3 Coil

<p>■ 22 mm (U1)</p>   <p>DA-0050 12 V DC 3,5 W DA-0051 24 V DC 3,5 W DA-0106 24 V AC 50/60 Hz 5 VA DA-0108 110 V AC 50/60 Hz 5 VA DA-0124 230 V AC 50/60 Hz 5 VA</p>	<p>■ 30 mm (U2)</p>   <p>DB-0501 12 V DC 11 W DB-0502 24 V DC 11 W DB-0507 24 V AC 50/60 Hz 10 VA DB-0509 110 V AC 50/60 Hz 10 VA DB-0510 230 V AC 50/60 Hz 10 VA</p>
<p>■ 30 mm (U3)</p>   <p>DC-0301 12 V DC 2,5 W DC-0302 24 V DC 2,5 W DC-0307 24 V AC 50/60 Hz 3,3 VA DC-0309 110 V AC 50/60 Hz 3,3 VA DC-0310 230 V AC 50/60 Hz 3,3 VA</p>	<p>For CSA-UL Certified coils see Certified Electropilot section</p>

Connectors

<p>■ Miniature connector without wires</p>  <p>D-500 Coil: U04/U05</p>	<p>■ Miniature connector with loose cables</p>  <p>D-530-30 D-530-50 D-530-200 Coil: U04/U05</p>	<p>■ Miniature connector with cable</p>  <p>D-535-30 D-535-50 D-535-200 Coil: U04/U05</p>
<p>■ 15 mm Connector</p>  <p>AM-5109 Coil: U05/U06</p>	<p>■ 20 mm Connector</p>  <p>AM-5110 Coil: U1</p>	<p>■ 30 mm Connector</p>  <p>AM-5111 Coil: U2/U3</p>

Operator/button modularity



PNEUMATIC / MECHANICAL OPERATORS

- 1 Pneumatic operator
- 2 Amplified pneumatic operator
- 3 Roller operator 1 position
- 4 Ball-push operator 1 position
- 5 Omni-directional antenna 1 position
- 6 Roller lever operator 1 position
- 7 Articulated roller lever operator 1 position
- 8 Key operator 1 position

MANUAL OPERATORS

- 9 Rotating selector
- 10 Rotating lever selector
- 11 Omni-directional operator
- 12 Push-pull operator
- 13 Recessed button
- 14 Head button
- 15 Button
- 16 Lever

VERRIDE

- 17 Threaded indirect operation
- 18 Indirect panel operation
- 19 Direct panel operation
- 20 Ball-push direct operation
- 21 Ball-push direct panel operation

Recessed button

Head button

 <ul style="list-style-type: none"> ■ 1 Position <ul style="list-style-type: none"> AI-3511 black ■ AI-3512 red ■ AI-3513 green ■ ■ For panel mounting 1 Position <ul style="list-style-type: none"> AI-3511Q black ■ AI-3512Q red ■ AI-3513Q green ■ 	 <ul style="list-style-type: none"> ■ 1 Position <ul style="list-style-type: none"> AI-3514 red ■ AI-3516 black ■ ■ For panel mounting 1 Position <ul style="list-style-type: none"> AI-3514Q red ■ AI-3516Q black ■ 	<ul style="list-style-type: none"> ■ 2 Positions <ul style="list-style-type: none"> AI-3514D red ■ AI-3516D black ■ ■ For panel mounting 2 Positions <ul style="list-style-type: none"> AI-3514QD red ■ AI-3516QD black ■
--	---	---

Button

Lever

 <ul style="list-style-type: none"> ■ 1 Position <ul style="list-style-type: none"> AI-3515 green ■ AI-3517 red ■ AI-3519 black ■ ■ For panel mounting 1 Position <ul style="list-style-type: none"> AI-3515Q green ■ AI-3517Q red ■ AI-3519Q black ■ 	 <ul style="list-style-type: none"> ■ 2 Positions <ul style="list-style-type: none"> AI-3524 black ■ ■ For panel mounting 2 Positions <ul style="list-style-type: none"> AI-3524Q black ■
--	--

Rotating selector for accident prevention



■ With light 1 position

AI-3521 black ■

■ For panel mounting with light 1 position

AI-3521Q black ■

■ With light 2 positions

AI-3520 black ■

■ For panel mounting with light 2 positions

AI-3520Q black ■

Rotating lever selector



■ With light 1 position

AI-3523 black ■

■ For panel mounting with light 1 position

AI-3523Q black ■

■ With light 2 positions

AI-3522 black ■

■ For panel mounting with light 2 positions

AI-3522Q black ■

Omni-directional lever



■ With centre return 1 position

AI-3525 black ■

■ For panel mounting with centre return 1 position

AI-3525Q black ■

Push-pull operator



■ 2 positions

AI-3526 black ■

■ For panel mounting 2 positions

AI-3526Q black ■

AI-3529



reducer for Ø 30,5 to Ø 22,5, to be used with AI-35..Q limit switches

Pneumatic and mechanical operators

■ Pneumatic operator



AI-3550

■ Roller operator with dust protection



AI-3560

■ Omni-directional antenna 1 position with centre return



AI-3563

■ Roller lever 1 position



AI-3570

■ Articulated one-way roller lever 1 position



AI-3571

■ Amplified pneumatic operator



AI-3551

■ Ball operator with dust protection



AI-3562

■ Push button 1 position



AI-3572

CHARACTERISTICS

Ambient temperature	-10°C + 45°C
Duty cycle ED ^(a)	100%
Tension tolerance	±10%

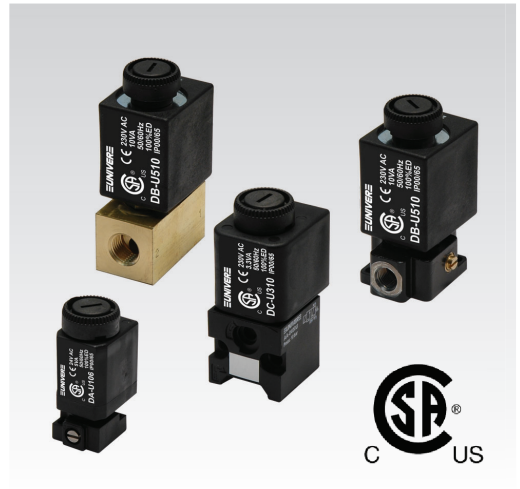
Products with this mark are certified by the Canadian CSA organization in compliance with the standards required by USA (US on the right of the logo) and Canada market (C on the left of the logo).

Certification N° 244884.

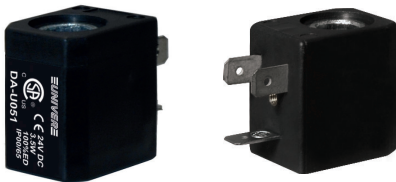
In compliance with:

CSA C22.2 No. 139-13

UL 429: 2013



U1 22 mm coil to be used with U1 electropilot



Part No.	Power consumption W		Rated voltage	Weight (Kg)
	hold	inrush		
DA-U050	3,5	3,5	12 V DC	0,06
DA-U051	3,5	3,5	24 V DC	0,06
DA-U101	6	6	12 V DC*	0,06
DA-U102	6	6	24 V DC	0,06
DA-U103	6	6	48 V DC*	0,06
DA-U104	6	6	110 V DC*	0,06
DA-U106	5 VA (Max)	7,8 VA (Max)	24 V AC/50-60 HZ	0,06
DA-U108	5 VA (Max)	7,8 VA (Max)	110 V AC/50-60 HZ	0,06
DA-U124	5 VA (Max)	7,8 VA (Max)	230 V AC/50-60 HZ	0,06

(*) = upon request

U2 30 mm coil to be used with U2 electropilot



Part No.	Power consumption W		Rated voltage	Weight (Kg)
	hold	inrush		
DB-U501	11	11	12 V DC	0,10
DB-U502	11	11	24 V DC	0,10
DB-U503	11	11	48 V DC*	0,10
DB-U504	11	11	110 V DC*	0,10
DB-U507	10 VA (Max)	16 VA (Max)	24 V AC/50-60 HZ	0,10
DB-U509	10 VA (Max)	16 VA (Max)	110 V AC/50-60 HZ	0,10
DB-U510	10 VA (Max)	16 VA (Max)	230 V AC/50-60 HZ	0,10

(*) = upon request

U3 30 mm coil to be used with U1 electropilot



Part No.	Power consumption W		Rated voltage	Weight (Kg)
	hold	inrush		
DC-U301	2,5	2,5	12 V DC	0,08
DC-U302	2,5	2,5	24 V DC	0,08
DC-U304	2,5	2,5	110 V DC*	0,08
DC-U307	3,3 VA (Max)	5 VA (Max)	24 V AC/50-60 HZ	0,08
DC-U309	3,3 VA (Max)	5 VA (Max)	110 V AC/50-60 HZ	0,08
DC-U310	3,3 VA (Max)	5 VA (Max)	230 V AC/50-60 HZ	0,08

(*) = upon request

(a) = Under continuous service maximum temperature will not compromise the functioning of the coil provided that the working position is ventilated

AM-5110

AM-5111



Connector for U1 coil
Protection according to IP 65. PG9 cable connection. 180° rotation on the coil
LED and moulded cable are available upon request.

DIN 43650 Connector for U2, U3 coil
Protection according to IP 65. PG9 cable connection. 360° rotation on the coil.
LED and moulded cable are available upon request.

Coils matching with electropilots/valves

<p>■ AA U1 Miniature electropilots</p> 	<p>■ AB U2 Miniature electropilots</p> 	<p>■ BE ISO 5599/1 valves size 1-2-3-4</p> 
<p>■ AE ISO 5599/1 light series valves size 1-2</p> 	<p>■ AC-N NAMUR valves</p> 	<p>■ CL/CM UNIVERSAL valves G1/8 - G1/4</p> 
<p>■ G7 26 mm - Valves and solenoid valves</p> 	<p>■ AC MIXED valves G1/8 - G1/4 - G1/2</p> 	<p>■ AF Poppet valves for compressed air G1/8 ÷ G1 1/2</p> 
<p>■ AG Poppet valves for vacuum G1/8 ÷ G1 1/2</p> 	<p>■ HZE1S Shut-off valves</p> 	

For technical details on electropilots/valves refer to our technical catalogue

YR240 Brass ball valve 2 ways with rotary actuator

■ Double/single acting



Standard supplied ATEX version

Temperature: -20 ÷ 120 °C

Fluid: air, water, etc.

Working pressure: G1/4 ÷ 1 40 bar
G1 1/4 32 bar
G1 1/2 ÷ 2 1/2 30 bar
G3 ÷ 4 25 bar

(based on working temperature)

Double acting

Part No.	Ø	DN
YR240008DA	8	G1/4
YR240010DA	10	G3/8
YR240015DA	15	G1/2
YR240020DA	20	G3/4
YR240025DA	25	G1
YR240032DA	32	G1 1/4
YR240040DA	40	G1 1/2
YR240050DA	50	G2
YR240065DA	65	G2 1/2
YR240080DA	80	G3
YR240100DA	100	G4

Single acting

Part No.	Ø	DN
YR240008SR	8	G1/4
YR240010SR	10	G3/8
YR240015SR	15	G1/2
YR240020SR	20	G3/4
YR240025SR	25	G1
YR240032SR	32	G1 1/4
YR240040SR	40	G1 1/2
YR240050SR	50	G2
YR240065SR	65	G2 1/2
YR240080SR	80	G3
YR240100SR	100	G4

YR250 Ball valve 2 ways AISI 316 with manual lever or rotary actuator

■ With manual lever



Part No.	Ø	DN
YR250008LM	8	G1/4
YR250010LM	10	G3/8
YR250015LM	15	G1/2
YR250020LM	20	G3/4
YR250025LM	25	G1
YR250032LM	32	G1 1/4
YR250040LM	40	G1 1/2
YR250050LM	50	G2
YR250065LM	65	G2 1/2
YR250080LM	80	G3

■ Double/single acting



Standard supplied ATEX version

Temperature: -25 ÷ 200 °C

Fluid: air, water, chemical agents, etc.

Working pressure: Max 63 bar
(based on working temperature)

Double acting

Part No.	Ø	DN
YR250008DA	8	G1/4
YR250010DA	10	G3/8
YR250015DA	15	G1/2
YR250020DA	20	G3/4
YR250025DA	25	G1
YR250032DA	32	G1 1/4
YR250040DA	40	G1 1/2
YR250050DA	50	G2
YR250065DA	65	G2 1/2
YR250080DA	80	G3

Single acting

Part No.	Ø	DN
YR250008SR	8	G1/4
YR250010SR	10	G3/8
YR250015SR	15	G1/2
YR250020SR	20	G3/4
YR250025SR	25	G1
YR250032SR	32	G1 1/4
YR250040SR	40	G1 1/2
YR250050SR	50	G2
YR250065SR	65	G2 1/2
YR250080SR	80	G3

YR260 Ball valve 2 ways AISI 316 (3 pieces) with manual lever or rotary actuator

■ With manual lever



Part No.	Ø	DN
YR260008LM	8	G1/4
YR260010LM	10	G3/8
YR260015LM	15	G1/2
YR260020LM	20	G3/4
YR260025LM	25	G1
YR260032LM	32	G1 1/4
YR260040LM	40	G1 1/2
YR260050LM	50	G2
YR260065LM	65	G2 1/2
YR260080LM	80	G3

■ Double/single acting



Standard supplied ATEX version

Temperature: -25 ÷ 200 °C

Fluid: air, water, chemical agents, etc.

Working pressure: Max 63 bar
(based on working temperature)

Double acting

Part No.	Ø	DN
YR260008DA	8	G1/4
YR260010DA	10	G3/8
YR260015DA	15	G1/2
YR260020DA	20	G3/4
YR260025DA	25	G1
YR260032DA	32	G1 1/4
YR260040DA	40	G1 1/2
YR260050DA	50	G2
YR260065DA	65	G2 1/2
YR260080DA	80	G3

Single acting

Part No.	Ø	DN
YR260008SR	8	G1/4
YR260010SR	10	G3/8
YR260015SR	15	G1/2
YR260020SR	20	G3/4
YR260025SR	25	G1
YR260032SR	32	G1 1/4
YR260040SR	40	G1 1/2
YR260050SR	50	G2
YR260065SR	65	G2 1/2
YR260080SR	80	G3

YR270 L-shaped ball valve 3 ways AISI 316 with manual lever or rotary actuator

■ With manual lever



Part No.	Ø	DN
YR270008LM	8	G1/4
YR270010LM	10	G3/8
YR270015LM	15	G1/2
YR270020LM	20	G3/4
YR270025LM	25	G1
YR270032LM	32	G1 1/4
YR270040LM	40	G1 1/2
YR270050LM	50	G2

■ Double/single acting



Standard supplied ATEX version

Temperature: -15 ÷ 230 °C
Fluid: air, water, chemical agents, etc.
Working pressure: Max 64 bar
 (based on working temperature)

Double acting			Single acting		
Part No.	Ø	DN	Part No.	Ø	DN
YR270008DA	8	G1/4	YR270008SR	8	G1/4
YR270010DA	10	G3/8	YR270010SR	10	G3/8
YR270015DA	15	G1/2	YR270015SR	15	G1/2
YR270020DA	20	G3/4	YR270020SR	20	G3/4
YR270025DA	25	G1	YR270025SR	25	G1
YR270032DA	32	G1 1/4	YR270032SR	32	G1 1/4
YR270040DA	40	G1 1/2	YR270040SR	40	G1 1/2
YR270050DA	50	G2	YR270050SR	50	G2

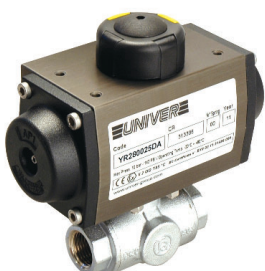
YR280 Brass L-shaped ball valve 3 ways with manual lever or rotary actuator

■ With manual lever



Part No.	Ø	DN
YR280008LM	8	G1/4
YR280010LM	10	G3/8
YR280015LM	15	G1/2
YR280020LM	20	G3/4
YR280025LM	25	G1
YR280032LM	32	G1 1/4
YR280040LM	40	G1 1/2
YR280050LM	50	G2

■ Double/single acting



Standard supplied ATEX version

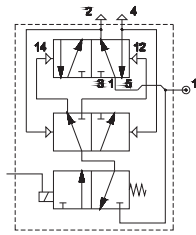
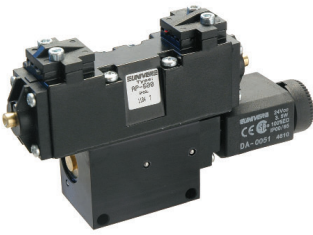
Temperature: -20 ÷ 160 °C
Fluid: air, water, chemical agents, etc.
Working pressure: G1/4 ÷ G3/4 30 bar, G1 16 bar,
 G1 1/4 ÷ G2 10 bar (based on working temperature)

Double acting			Single acting		
Part No.	Ø	DN	Part No.	Ø	DN
YR280008DA	8	G1/4	YR280008SR	8	G1/4
YR280010DA	10	G3/8	YR280010SR	10	G3/8
YR280015DA	15	G1/2	YR280015SR	15	G1/2
YR280020DA	20	G3/4	YR280020SR	20	G3/4
YR280025DA	25	G1	YR280025SR	25	G1
YR280032DA	32	G1 1/4	YR280032SR	32	G1 1/4
YR280040DA	40	G1 1/2	YR280040SR	40	G1 1/2
YR280050DA	50	G2	YR280050SR	50	G2

Binary Counter (Flip Flop)

■ AP-500

Electrical override



Working pressure: 10 bar

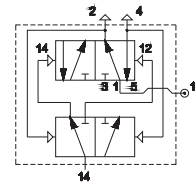
Energizing pressure: 3 bar

Ambient temperature: -30 ÷ +80 °C

Coil: U1 - DA series

■ AP-520

Pneumatic override

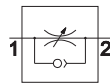


Solenoid valves are supplied without coil/connector/locking nut

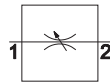
Flow control valve - metallic body

■ AM-50

One-way and two-way flow control valve
M5 - G1/8 - G1/4 - G3/8 - G1/2



One-way regulation

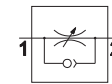


Two-way regulation

		Ø mm
AM-5060	M5	1
AM-5061	G1/8	1
AM-5062	G1/8	2,25
AM-5063	G1/8	3,5
AM-5064	G1/4	5
AM-5065	G1/4	6
AM-5066	G3/8	6
AM-5067	G1/2	9
AM-5070	M5	1
AM-5071	G1/8	1
AM-5072	G1/8	2,25
AM-5074	G1/4	5
AM-5076	G3/8	6
AM-5077	G1/2	9

■ AM-50

One-way flow control valve G1/2 - G3/4 - G1



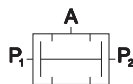
One-way regulation

		Ø mm
AM-5090	G1/2	9
AM-5091	G3/4	9
AM-5092	G1	12

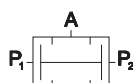
Signal processing valve

■ AM-51

Two-pressure valve "AND"



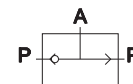
AM-5160
threaded body G1/8



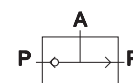
AM-5161
push-in fittings Ø4x2

■ AM-51

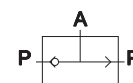
Selector valve "OR"



AM-5162
threaded body G1/8



AM-5163
push-in fittings Ø4x2

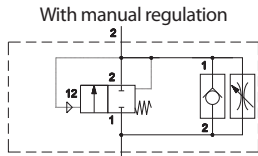


AM-5164
threaded body G1/4

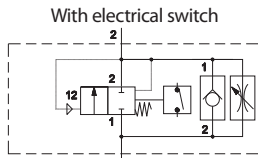
Available ATEX version upon request
See ATEX Catalogue for types and versions

Gradual starter

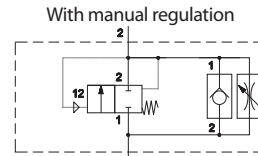
AM-52
Gradual starter G1/8 ÷ G1



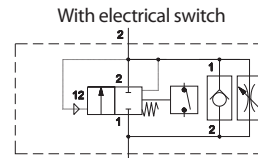
		Ø mm
AM-5240	G1/8	6,5
AM-5241	G1/4	6,5
AM-5242	G1/4	9,5
AM-5243	G3/8	9,5



		Ø mm
AM-5242E	G1/8	9,5
AM-5243E	G3/8	9,5



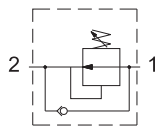
		Ø mm
AM-5254	G1/2	15
AM-5255	G3/4	15
AM-5256	G1	24



		Ø mm
AM-5259	G1/2	15
AM-5260	G3/4	15
AM-5261	G1	24

Economizer

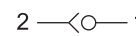
AM-53
Economizer G1/8 ÷ G1



		Ø mm
AM-5350	G1/8	6,5
AM-5351	G1/4	6,5
AM-5352	G1/4	9,5
AM-5353	G3/8	9,5
AM-5354	G1/2	15
AM-5355	G3/4	15
AM-5356	G1	24

Check valve

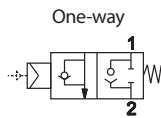
AM-54
Check valve G1/2 - G3/4 - G1



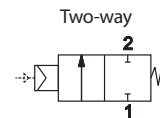
		Ø mm
AM-5400	G1/2	15
AM-5401	G3/4	15
AM-5402	G1	24

Blocking valve

AM-55
Blocking valve



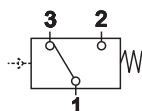
		Ø mm
AM-5500	G1/8	6,5
AM-5501	G1/4	6,5
AM-5502	G1/4	9,5
AM-5503	G3/8	9,5
AM-5504	G1/2	15



		Ø mm
AM-5510	G1/8	6,5
AM-5511	G1/4	6,5
AM-5512	G1/4	9,5
AM-5513	G3/8	9,5
AM-5514	G1/2	15

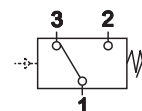
Transducer and pressure switch

AM-5200
Pneumo-electrical transducer



AM-5200

AM-5220
Adjustable pressure switch



AM-5220

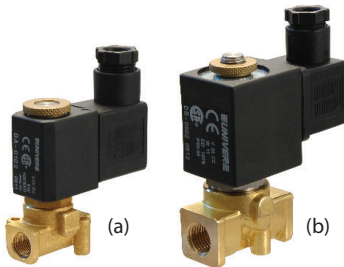
Available ATEX version upon request
See ATEX Catalogue for types and versions

CHARACTERISTICS

Ambient temperature	-20 ÷ +50 °C
Fluid temperature	-10 ÷ +95 °C
Fluid	water, air, non-corrosive gases
Valve body	brass
Seals	NBR
Coil	U1 U2
Power consumption	see coil section
Voltage	24 V DC, 24 V AC, 110 V AC, 220 V AC 50/60 Hz

Other versions available upon request

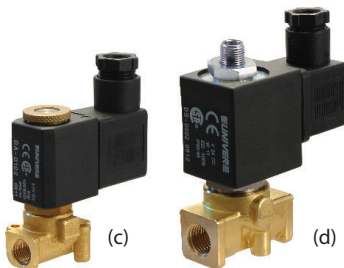
- VITON, EPDM seals; EPM seals for food industry
- Nickel-plated brass or AISI 316 stainless steel body
- NO version
- G1 1/4 - G1 1/2 - G2


2 ways NC direct action


Part No.	Connections	Nom. bore (mm)	Pressure (bar)				Coil	KV (l/min)
			Nominal	min	Max AC	Max DC		
YF210061D (a)	G1/8	2	25	0	12	10	U1	1,5
YF210062D (b)	G1/8	2	25	0	22	20	U2	1,7
YF210082D (b)	G1/4	3,5	100	0	10	8	U2	5,4

2 ways NC servo-assisted diaphragm


Part No.	Connections	Nom. bore (mm)	Pressure (bar)				Coil	KV (l/min)
			Nominal	min	Max AC	Max DC		
YF210151S	G1/2	12,7	25	0,15	18	16	U1	40
YF210201S	G3/4	19	25	0,15	16	13	U1	90
YF210251S	G1	25	25	0,15	12	10	U1	176

3 ways NC direct action


Part No.	Connections	Nom. bore (mm)	Pressure (bar)				Coil	KV (l/min)
			Nominal	min	Max AC	Max DC		
YF310061D (c)	G1/8	1,5	10	0	10	10	U1	1
YF310082D (d)	G1/4	2,4	10	0	10	10	U2	2,3

Coils

U1

YFDA-0224	24 V AC - 50/60 Hz - 8 VA
YFDA-0211	110 V AC - 50/60 Hz - 8 VA
YFDA-0223	230 V AC - 50/60 Hz - 8 VA
DA-0102	24 V DC - 6 W


U2

YFDB-0224	24 V AC - 50/60 Hz - 13 VA
YFDB-0211	110 V AC - 50/60 Hz - 13 VA
YFDB-0223	230 V AC - 50/60 Hz - 13 VA
DB-0502	24 V DC - 11 W

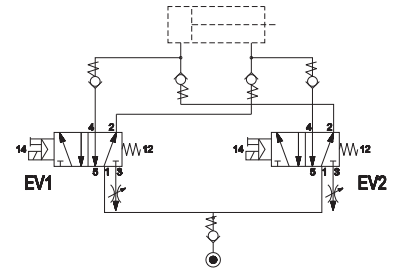
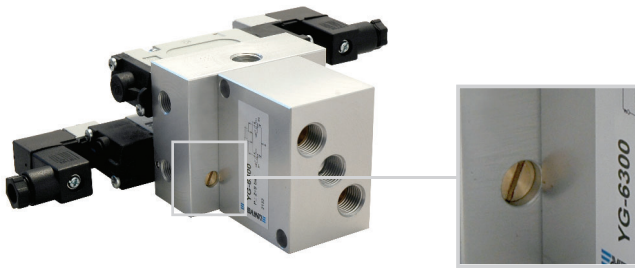
Solenoid valves are supplied with locking nut, without coil and connector

CHARACTERISTICS

Ambient temperature	-20 ÷ +50 °C
Fluid	50 µm filtered air, with or without lubrication
Pressure	1,5 ÷ 9 bar
Connections	G1/4
Pace regulators	embodied
Function	it allows cylinders to stop with highly precise position repeatability
Solenoid Valves	GL series
Commutation system	spool
Electropilot/Coil	A series/U05 series
Voltage	24 V DC - 12 V DC - 24 V AC - 110 V AC - 230 V AC (only version with external electrical connection)
Power consumption	U05 = 2 W (DC) 2,3 VA (AC)
Manual override	recessed button - 1 position



■ Embodied pace regulators



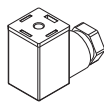
For further information please contact our Sales Office

DD- ...

AM-5109



- DD-040 24 V AC
- DD-041 12 V DC
- DD-051 24 V DC
- DD-060 110 V AC
- DD-070 230 V AC

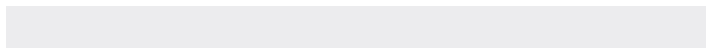


15 mm U05 Coil - Faston

15 mm Connectors

4

Air Treatment



Air Treatment Units

HZE0-05-1-2	2
HZE3	10



Purifier filters
Oil separator filters

HZE1G/2G	16
HZE1GD/2GD	18



Precision regulator

HZRP30	19
--------	----



Microregulators

HZRS	20
------	----



Electropneumatic
proportional regulator

HZRE	21
------	----



MODULAR

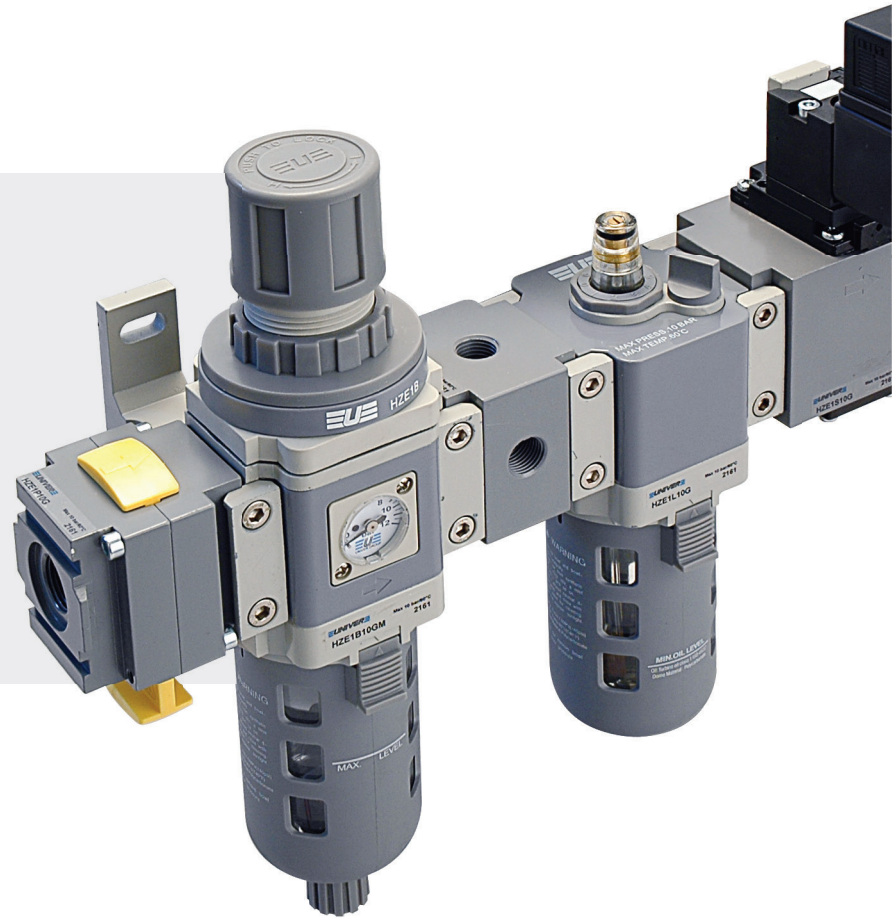
40 mm - HZE0
 50 mm - HZE05
 63 mm - HZE1
 80 mm - HZE2

INTEGRATED GAUGE

Standard supplied

COMPLETE SOLUTION

Possibility of assembling combinations complete with accessories



G1/4

Size 0



FR+L

600
NI/min

G1/4 - G3/8

Size 05



FR+L

1500
NI/min

G3/8 - G1/2

Size 1



FR+L

2800
NI/min

G1/2

Size 2



FR+L

4300
NI/min



HZE-Y
Gradual starter



HZE-N
Diverter block



HZE-P
Lockable valve



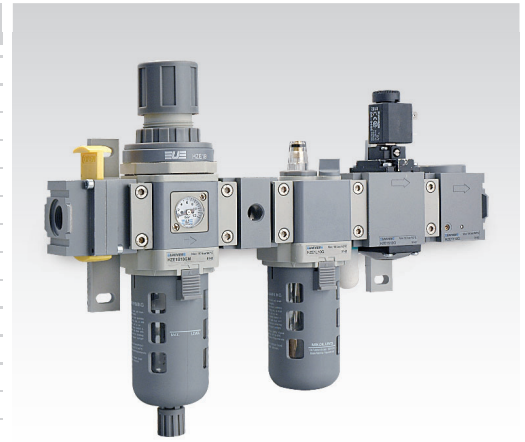
HZE-S
Shut-off valve



HZE-RL
Lockable regulator

CHARACTERISTICS

Ambient temperature	0 ÷ +60 °C
Fluid	filtered air, with or without lubrication
Working pressure	10 bar
Max pressure	15 bar
Size	0 - 05 - 1 - 2
Body	tecnopolymer with metal threaded elements (size 0) die-cast aluminium (size 05 - 1 - 2)
Knob	tecnopolymer
Ring nut	tecnopolymer
Bowl	polycarbonate
Bowl guard	tecnopolymer (size 05 - 1 - 2)
Filter element	polyethylene
Seals	NBR
Springs	steel
Diaphragm	fabric reinforced rubber



For round gauge mounting (HZ9P):

Size 0/05 = Replace HZ9464G gauge with HZE7Z480 square adaptor G1/8, to be ordered separately

Size 1-2 = Replace HZ9464G gauge with HZE7Z480 square adaptor G1/8 placed on the rear side of the regulator or filter regulator

CODIFICATION KEY

H	Z	E	0	B	0	8	G		M	
1	2	3	4	5	6	7				

1 Series

HZE = Air treatment units with standard manual drain

2 Size

0 = Small (G1/4)
05 = Intermediate (G1/4 - G3/8)
1 = Medium (G3/8 - G1/2)
2 = Large (G1/2)

3 Model

F = Filter
R = Regulator
L = Lubricator
B = Filter regulator
D = Filter regulator+Lubricator (FR+L)
C = Filter+Regulator+Lubricator (F+R+L)

4 Thread

08G = G1/4 (sz. 0 - 05)
10G = G3/8 (sz. 05 - 1)
15G = G1/2 (sz. 1-2)
20G = G3/4 (sz. 2) *
25G = G1 (sz. 2) *

* = with threaded ends

5 Option

A = Automatic drain (except for size 0 - 05)
S = Semi-automatic drain

6 Pressure gauge

M = Integrated square pressure gauge (standard supplied)
Square adaptor G1/8 upon request

7 ATEX option

X = ATEX (upon request)
See ATEX Catalogue for types and versions

Filter

	0	05	1	2		
Part No.	HZE0F08G	HZE05F08G	HZE05F10G	HZE1F10G	HZE1F15G	HZE2F15G
Connections	G1/4	G1/4	G3/8	G3/8	G1/2	G1/2
Filtration rate (µm)	5	5	5	5	5	5
Nominal flow rate (NI/min) ^(A)	1100	1500	2000	2300	2500	5000
Max inlet pressure (bar-MPa-psi)	10 - 1 - 145	10 - 1 - 145	10 - 1 - 145	10 - 1 - 145	10 - 1 - 145	10 - 1 - 145
Condensation drain capacity (cm³)	12	40	45	45	80	80
Condensation drain	manual	manual	manual	manual	manual	manual

(A) = Inlet pressure 7 bar, Δp 0,5 bar

Regulator



Size	0		05		1		2
Part No.	HZE0R08GM		HZE05R08GM	HZE05R10GM	HZE1R10GM	HZE1R15GM	HZE2R15GM
Connections	G1/4		G1/4	G3/8	G3/8	G1/2	G1/2
Nominal flow rate (NI/min) ^(A)	1000		1900	2500	2800	3500	5000
Max inlet pressure (bar-MPa-psi)	10 - 1 - 145		10 - 1 - 145		10 - 1 - 145		10 - 1 - 145
Pressure adjustment-relieving version (bar)	0,5 ÷ 8,5		0,5 ÷ 8,5		0,5 ÷ 8,5		0,5 ÷ 8,5
Pressure gauge (standard supplied)	HZ9464G		HZ9464G		HZ9464G		HZ9464G
Pressure gauge adaptor	G1/8 ^(B)		G1/8 ^(B)		G1/8 ^(C)		G1/8 ^(C)

(A) = Inlet pressure 7 bar, outlet pressure 5 bar - Δp 1 bar

(B) = Upon request (replace HZ9464G gauge with HZE7Z480 square adaptor G1/8, to be ordered separately)

(C) = Standard supplied (replace HZ9464G gauge with HZE7Z480 square adaptor G1/8 placed on the rear side)

Other available versions

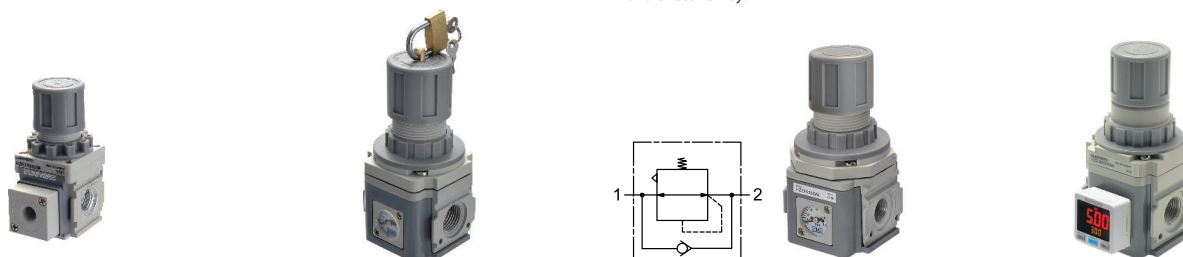
■ Without manometer size 0-05

■ Lockable knob size 05-1-2

■ Check valve size 0-05-1-2

The check valve inside the regulator allows to relieve downstream pressure in a quick and effective way.

■ Regulator with integrated digital pressure switch size 0-05-1-2



Size	Part No.
0	HZE0R08G
05	HZE05R08G - HZE05R10G

Size	Part No.
05	HZE05RL08GM - HZE05RL10GM
1	HZE1RL10GM - HZE1RL15GM
2	HZE2RL15GM

Size	Part No.
0	HZE0R08GMV
05	HZE05R08GMV - HZE05R10GMV
1	HZE1R10GMV-HZE1R15GMV
2	HZE2R15GMV

Size	Part No.
0	HZE0R08GQ
05	HZE05R08GQ - HZE05R10GQ
1	HZE1R10GQ-HZE1R15GQ
2	HZE2R15GQ

For M8 pressure switch connection, add "T" at the end of the code

Lubricator



Size	0		05		1		2
Part No.	HZE0L08G		HZE05L08G	HZE05L10G	HZE1L10G	HZE1L15G	HZE2L15G
Connections	G1/4		G1/4	G3/8	G3/8	G1/2	G1/2
Nominal flow rate (NI/min) ^(A)	1400		1800	3800	4400		7000
Max inlet pressure (bar-MPa-psi)	10 - 1 - 145		10 - 1 - 145		10 - 1 - 145		10 - 1 - 145
Bowl capacity (cm ³)	20		70		85		170
Recommended oil	ISO VG 32		ISO VG 32		ISO VG 32		ISO VG 32
Min. working flow rate (NI/min)	15		30		30		65

(A) = Inlet pressure 7 bar - Δp 0,5 bar

Filter regulator



Size	0		05		1	2
Part No.	HZE0B08GM		HZE05B08GM	HZE05B10GM	HZE1B10GM	HZE2B15GM
Connections	G1/4		G1/4	G3/8	G3/8	G1/2
Filtration rate (µm)	5		5		5	
Nominal flow rate (NI/min) ^(A)	600		1500	2000	2500	3000
Max inlet pressure (bar-MPa-psi)	10 - 1 - 145		10 - 1 - 145		10 - 1 - 145	
Pressure adjustment - relieving version (bar)	0,5 ÷ 8,5		0,5 ÷ 8,5		0,5 ÷ 8,5	
Pressure gauge (standard supplied)	HZ9464G		HZ9464G		HZ9464G	
Pressure gauge adaptor	G1/8 ^(B)		G1/8 ^(B)		G1/8 ^(C)	
Condensation drain capacity (cm ³)	12		40		45	
Condensation drain	manual		manual		manual	

(A) = Inlet pressure 7 bar, outlet pressure 5 bar - Δp 1 bar

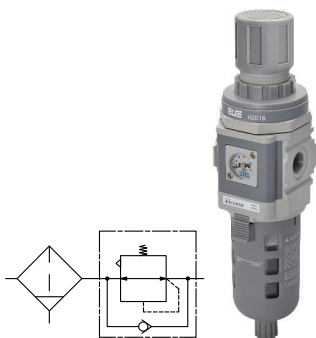
(B) = Upon request (replace HZ9464G gauge with HZE7Z480 square adaptor G1/8, to be ordered separately)

(C) = Standard supplied (replace HZ9464G gauge with HZE7Z480 square adaptor G1/8 placed on the rear side)

Other available versions

■ Check valve size 0-05-1-2

The check valve inside the filter regulator allows to relieve downstream pressure in a quick and effective way.



Size	Part No.
0	HZE0B08GMV
05	HZE05B08GMV - HZE05B10GMV
1	HZE1B10GMV - HZE1B15GMV
2	HZE2B15GMV

■ Filter regulator with integrated digital pressure switch size 0-05-1-2

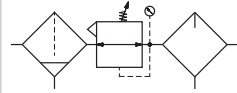


Size	Part No.
0	HZE0B08GQ
05	HZE05B08GQ - HZE05B10GQ
1	HZE1B10GQ - HZE1B15GQ
2	HZE2B15GQ

For M8 pressure switch connection, add "T" at the end of the code

Filter regulator + Lubricator

4



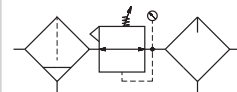
Size	0		05		1		2
Part No.	HZE0D08GM		HZE05D08GM	HZE05D10GM	HZE1D10GM	HZE1D15GM	HZE2D15GM
Connections	G1/4		G1/4	G3/8	G3/8	G1/2	G1/2
Filtration rate (µm)	5		5		5		5
Nominal flow rate (NI/min) ^(A)	600		1500	2000	2500	2800	4300
Max inlet pressure (bar-MPa-psi)	10 - 1 - 145		10 - 1 - 145		10 - 1 - 145		10 - 1 - 145
Fluid	compressed air		compressed air		compressed air		compressed air
Pressure adjustment - relieving version (bar)	0,5 ÷ 8,5		0,5 ÷ 8,5		0,5 ÷ 8,5		0,5 ÷ 8,5
Pressure gauge (standard supplied)	HZ9464G		HZ9464G		HZ9464G		HZ9464G
Pressure gauge adaptor	G1/8 ^(B)		G1/8 ^(B)		G1/8 ^(C)		G1/8 ^(C)
Condensation drain capacity (cm ³)	12		40		45		80
Condensation drain	manual		manual		manual		manual
Recommended oil	ISO VG 32		ISO VG 32		ISO VG 32		ISO VG 32
Min. working flow rate (NI/min)	15		30		30		65

(A) = Inlet pressure 7 bar, outlet pressure 5 bar - Δp 1 bar

(B) = Upon request (replace HZ9464G gauge with HZE7Z480 square adaptor G1/8, to be ordered separately)

(C) = Standard supplied (replace HZ9464G gauge with HZE7Z480 square adaptor G1/8 placed on the rear side)

Filter + Regulator + Lubricator



Size	0		05		1		2
Part No.	HZE0C08GM		HZE05C08GM	HZE05C10GM	HZE1C10GM	HZE1C15GM	HZE2C15GM
Connections	G1/4		G1/4	G3/8	G3/8	G1/2	G1/2
Filtration rate (µm)	5		5		5		5
Nominal flow rate (NI/min) ^(A)	550		1300	1500	1800	2000	3000
Max inlet pressure (bar-MPa-psi)	10 - 1 - 145		10 - 1 - 145		10 - 1 - 145		10 - 1 - 145
Fluid	compressed air		compressed air		compressed air		compressed air
Pressure adjustment - relieving version (bar)	0,5 ÷ 8,5		0,5 ÷ 8,5		0,5 ÷ 8,5		0,5 ÷ 8,5
Pressure gauge (standard supplied)	HZ9464G		HZ9464G		HZ9464G		HZ9464G
Pressure gauge adaptor	G1/8 ^(B)		G1/8 ^(B)		G1/8 ^(C)		G1/8 ^(C)
Condensation drain capacity (cm ³)	12		40		45		80
Condensation drain	manual		manual		manual		manual
Recommended oil	ISO VG 32		ISO VG 32		ISO VG 32		ISO VG 32
Min. working flow rate (NI/min)	15		30		30		65

(A) = Inlet pressure 7 bar, outlet pressure 5 bar - Δp 1 bar

(B) = Upon request (replace HZ9464G gauge with HZE7Z480 square adaptor G1/8, to be ordered separately)

(C) = Standard supplied (replace HZ9464G gauge with HZE7Z480 square adaptor G1/8 placed on the rear side)

Lockable Valve

	0	1^(B)	
Part No.	HZE0P08G	HZE1P10G	HZE1P15G
Connections	G1/4	G3/8	G1/2
Nominal flow rate (NI/min)^(A)	900	5000	
Max inlet pressure (bar-MPa-psi)	10 - 1 - 145		
Fluid	compressed air		

(A) = Inlet pressure 7 bar, outlet pressure 5 bar - Δp 1 bar
 (B) = Also usable with sizes 05 and 2

Diverter Block

	0	1^(B)	
Part No.	HZE0N08G	HZE1N10G	HZE1N15G
Connections	In/Out G1/4 Auxiliary G1/8	In/Out G3/8	In/Out G1/2 Auxiliary G1/4
Max inlet pressure (bar-MPa-psi)	10 - 1 - 145		
Fluid	compressed air		

(B) = Also usable with sizes 05 and 2
 Use blanking plugs to close unused ways (not included)

Intermediate Diverter block

1^(B)	
Part No.	HZE1N1006G
Connections	Auxiliary G3/8 - G1/8
Max inlet pressure (bar-MPa-psi)	10 - 1 - 145
Fluid	compressed air

(B) = Also usable with sizes 05 and 2
 Use blanking plugs to close unused ways (not included)

Shut-off valve

	0	1 ^(B)	
Size	HZE0S08G	HZE1S10G	HZE1S15G
Part No.	G1/4	G3/8	G1/2
Connections	900	2800	
Nominal flow rate (NI/min) ^(A)	10 - 1 - 145	10 - 1 - 145	
Max inlet pressure (bar-MPa-psi)	2 - 0,16 - 23	2 - 0,2 - 29	
Min. pressure (bar-MPa-psi)	compressed air	compressed air	
Fluid	poppet	poppet	
Commutation system	3/2 NC	3/2 NC	
Ways/Positions	indirect electropneumatic	indirect electropneumatic	
Control	8	10	
Nominal diameter (mm)	U1 AA series	U1 AA series	
Electropilot	DA/DC	DA/DC	
Coil	two-position screw	two-position screw	
Manual Override			

(A) = Inlet pressure 7 bar, outlet pressure 5 bar - Δp 1 bar
 (B) = Also usable with sizes 05 and 2

Coils

	<p>■ U1</p> <p>DA-0050 12 V DC DA-0051 24 V DC DA-0106 24 V AC/50-60 Hz DA-0108 110 V AC/50-60 Hz DA-0124 230 V AC/50-60 Hz</p>		<p>■ U3</p> <p>DC-0301 12 V DC DC-0302 24 V DC DC-0307 24 V AC/50-60 Hz DC-0309 110 V AC/50-60 Hz DC-0310 230 V AC/50-60 Hz</p>
--	---	--	---

Other available versions

<p>■ Size 0 U05</p>	<p>■ Size 1 U05</p>	<p>■ Size 1 U3 CNOMO</p>
---------------------	---------------------	--------------------------

Solenoid valves are supplied with locking nut, without coil

Gradual Starter

	0	1 ^(B)	
Size	HZE0Y08G	HZE1Y10G	HZE1Y15G
Part No.	G1/4	G3/8	G1/2
Connections	900	2200	
Nominal flow rate (NI/min) ^(A)	10 - 1 - 145	10 - 1 - 145	
Max inlet pressure (bar-MPa-psi)	2	3,5	
Min. pressure (bar)	compressed air	compressed air	
Fluid			

(A) = Inlet pressure 7 bar, outlet pressure 5 bar - Δp 1 bar
 (B) = Also usable with sizes 05 and 2

HZE0/05/1Z200	HZE0/05/1/2Z210	HZE0/05/1/2Z300	HZE0/05/1/2Z310	HZE7Z480/90	HZE2Z500/501
Assembly kit Size 0 HZE0Z200 Size 05 HZE05Z200 Size 1-2 HZE1Z200	T-bracket assembly kit Size 0 HZE0Z210 Size 05 HZE05Z210 Size 1 HZE1Z210 Size 2 HZE2Z210	C-bracket Size 0 HZE0Z300 Size 05 HZE05Z300 Size 1 HZE1Z300 Size 2 HZE2Z300	Regulator L-bracket Size 0 HZE0Z310 Size 05 HZE05Z310 Size 1 HZE1Z310 Size 2 HZE2Z310	Threaded adaptor for pressure gauge Size 0-05-1-2 G1/8 HZE7Z480 G1/4 HZE7Z490 Screw torque: Max 0,6 Nm	Threaded ends Size 2 G3/4 HZE2Z500 G1 HZE2Z501

Filter and filter regulator accessories

HZE0/05/1/2Z600	HZE0/05/1/2Z600SS	HZE7Z400	HZE0/1Z401	HZE0/1Z402
Standard bowl with manual drain Size 0 HZE0Z600 Size 05 HZE05Z600 Size 1 HZE1Z600 Size 2 HZE2Z600	Bowl with semi-automatic drain Size 0 HZE0Z600SS Size 05 HZE05Z600SS Size 1 HZE1Z600SS Size 2 HZE2Z600SS	Automatic drain Size 1-2	Semi-automatic drain Size 0 HZE0Z401 Size 05-1-2 HZE1Z401	Manual drain Size 0 HZE0Z402 Size 05-1-2 HZE1Z402

HZE0/05/1/2Z660



Filter elements 5 µm
 Size 0 HZE0Z660
 Size 05 HZE05Z660
 Size 1 HZE1Z660
 Size 2 HZE2Z660
 Other filter elements upon request

Regulator and filter regulator accessories

HZE0/05/1/2Z602	HZE05/1/2Z652/4/8	HZE0/05/1/2Z603	HZE0/05/1/2Z610/1
Knob Size 0 HZE0Z602 Size 05 HZE05Z602 Size 1 HZE1Z602 Size 2 HZE2Z602	Regulator spring Size 05 Pressure adjustment HZE05Z658 0,5 ÷ 8,5 Size 1 HZE1Z652 0,5 ÷ 1,7 HZE1Z654 0,5 ÷ 3,5 HZE1Z658 0,5 ÷ 8,5 Size 2 HZE2Z652 0,5 ÷ 1,7 HZE2Z654 0,5 ÷ 3,5 HZE2Z658 0,5 ÷ 8,5	Ring nut for panel Size 0 HZE0Z603 Size 05 HZE05Z603 Size 1 HZE1Z603 Size 2 HZE2Z603	Diaphragm kit Size 0 HZE0Z610 relieving HZE0Z611 non-relieving Size 05 HZE05Z610 relieving HZE05Z611 non-relieving Size 1 HZE1Z610 relieving HZE1Z611 non-relieving Size 2 HZE2Z610 relieving HZE2Z611 non-relieving

Lubricator accessories

HZE0/05/1/2Z601	HZE7Z470	HZ9N	HZ9NP50	HZ9N12
Standard bowl Size 0 HZE0Z601 Size 05 HZE05Z601 Size 1 HZE1Z601 Size 2 HZE2Z601	Lubricator transparent dome Size 0-05-1-2 HZE7Z470	See ACCESSORIES chapter		

CHARACTERISTICS

Ambient temperature	-5 ÷ 60 °C
Fluid	filtered compressed air, with or without lubrication
Working pressure	10 bar (pressure regulator 15 bar)
Max pressure	15 bar (pressure regulation 20 bar)
Body	die-cast aluminium (painted)
Knob	tecnopolymer
Ring nut	zinc-plated steel
Bowl	polycarbonate
Bowl guard	tecnopolymer
Filter element	polyethylene
Seals	NBR
Springs	steel
Diaphragm	fabric reinforced rubber



CODIFICATION KEY

H	Z	E	3	B	2	5	G	
1	2	3	4	5				

1 Series	2 Size	3 Model	4 Thread
HZE = Air treatment units with standard manual/semi-automatic drain	3 = G1	F = Filter R = Regulator L = Lubricator B = Filter regulator (FR) D = Filter regulator + Lubricator (FR+L) C = Filter + Regulator + Lubricator (F+R+L)	25G = G1

5 Option
A = Automatic drain S = Manual/semi-automatic drain (standard supplied)
Excluding regulator (R) and lubricator (L)

Filter



Part No.	HZE3F25GS
Connections	G1
Filtration rate (µm)	40
Nominal flow rate (NI/min)^(A)	10000
Max inlet pressure (bar-MPa-psi)	10-1-145
Working pressure (bar) with manual/semi-automatic drain	0,5-10
Working pressure (bar) with automatic drain	1,5-10
Fluid	compressed air
Temperature (°C)	-5 ÷ 60
Condensation drain capacity (cm³)	75
Condensation drain^(B)	manual/semi-automatic
Weight (g)	1180
Mounting position	vertical

(A) = Inlet pressure 7 bar - Δp 0,5 bar
(B) = manual drain with semi-automatic function at < 0,5 bar pressure

Regulator

Part No.	HZE3R25G
Connections	G1
Nominal flow rate (NI/min)^(A)	10000
Max inlet pressure (bar-MPa-psi)	15 - 1,5 - 217
Pressure adjustment - relieving version (bar)	0,5 ÷ 8,5
Pressure gauge adaptor	G1/8
Fluid	filtered air
Temperature (°C)	-5 ÷ 60
Weight (g)	1460
Mounting position	any

(A) = Inlet pressure 7 bar, outlet pressure 5 bar - Δp 1 bar
 HZE3Z310R L bracket standard supplied, ring nut for panel not included

Other available versions

- Regulator with integrated digital pressure switch size 3



Part No.
HZE3R25GQ
HZE3R25GT with M8 connector

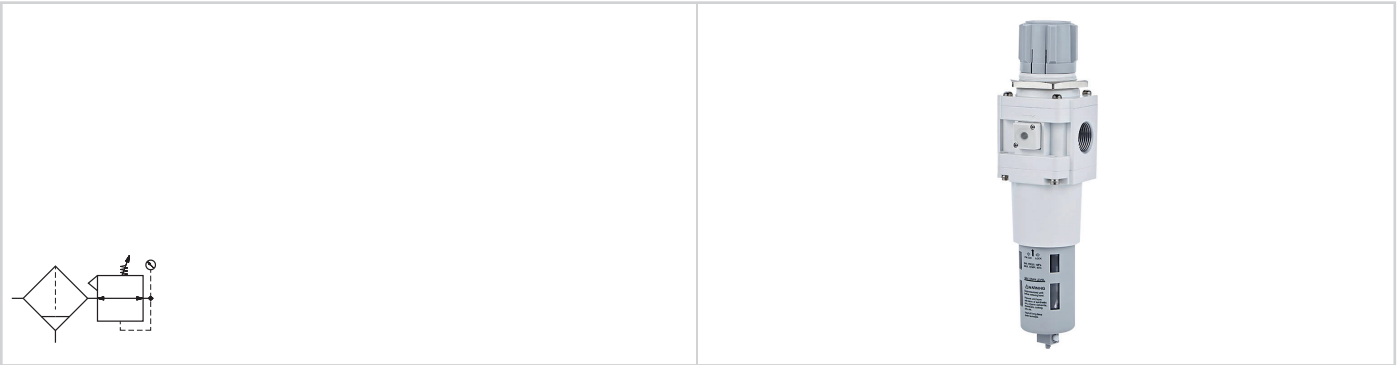
Lubricator

Part No.	HZE3L25G
Connections	G1
Nominal flow rate (NI/min)^(A)	10000
Max inlet pressure (bar-MPa-psi)	10-1-145
Working pressure (bar)	0,5-10
Fluid	filtered air
Temperature (°C)	-5 ÷ 60
Bowl capacity (cm³)	200
Weight (g)	1260
Mounting position	vertical
Recommended oil	ISO VG 32
Min. working flow rate (NI/min)	33

(A) = Inlet pressure 7 bar - Δp 0,2 bar

Filter regulator

4



Part No.	HZE3B25GS
Connections	G1
Filtration rate (µm)	40
Nominal flow rate (NI/min) ^(A)	10000
Max inlet pressure (bar-MPa-psi)	10-1-145
Working pressure (bar) with manual/semi-automatic drain	0,5-10
Working pressure (bar) with automatic drain	1,5-10
Pressure adjustment - relieving version (bar)	0,5 ÷ 8,5
Pressure gauge adaptor	G1/8
Fluid	compressed air
Temperature (°C)	-5 ÷ 60
Condensation drain capacity (cm ³)	75
Drain capacity ^(B)	manual/semi-automatic
Weight (g)	1940
Mounting position	vertical

(A) = Inlet pressure 7 bar, outlet pressure 5 bar - Δp 2 bar
 (B) = manual drain with semi-automatic function at < 0,5 bar pressure
 HZE3Z310R L bracket standard supplied, ring nut for panel not included

Other available versions

- Filter regulator with integrated digital pressure switch size 3



Part No.
HZE3B25GSQ
HZE3B25GST with M8 connector

Filter regulator + Lubricator



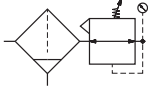
Part No.	HZE3D25GS
Connections	G1
Filtration rate (µm)	40
Nominal flow rate (NI/min) ^(A)	10000
Max inlet pressure (bar-MPa-psi)	10-1-145
Working pressure (bar) with manual/semi-automatic drain	0,5-10
Working pressure (bar) with automatic drain	1,5-10
Pressure adjustment - relieving version (bar)	0,5 ÷ 8,5
Pressure gauge adaptor	G1/8
Fluid	compressed air
Temperature (°C)	-5 ÷ 60
Condensation drain capacity (cm ³)	75
Bowl capacity (cm ³)	200
Drain capacity ^(B)	manual/semi-automatic
Weight (g)	3480
Mounting position	vertical
Recommended oil	ISO VG 32
Min. working flow rate (NI/min)	33

(A) = Inlet pressure 7 bar, outlet pressure 5 bar - Δp 2 bar

(B) = manual drain with semi-automatic function at < 0,5 bar pressure

Filter + Regulator + Lubricator

4



Part No.	HZE3C25GS
Connections	G1
Filtration rate (µm)	40
Nominal flow rate (NI/min)^(A)	10000
Max inlet pressure (bar-MPa-psi)	10-1-145
Pressure adjustment - relieving version (bar)	0,5 ÷ 8,5
Working pressure (bar) with manual/semi-automatic drain	0,5-10
Working pressure (bar) with automatic drain	1,5-10
Pressure gauge adaptor	G1/8
Fluid	compressed air
Temperature (°C)	-5 ÷ 60
Condensation drain capacity (cm³)	75
Bowl capacity (cm³)	200
Drain capacity^(B)	manual/semi-automatic
Weight (g)	4200
Mounting position	vertical
Recommended oil	ISO VG 32
Min. working flow rate (NI/min)	33

(A) = Inlet pressure 7 bar, outlet pressure 5 bar - Δp 1 bar

(B) = manual drain with semi-automatic function at < 0,5 bar pressure

Diverter Block



Size	3
Part No.	HZE3N
Connections	Auxiliary G1/2
Max inlet pressure (bar-MPa-psi)	10 - 1 - 145
Fluid	compressed air

HZE3Z200	HZE3Z210	HZE3Z310R	HZE3Z310F	HZE7Z490
Assembly kit Size 3 HZE3Z200	T-bracket assembly kit Size 3 HZE3Z210	L-bracket (standard supplied for regulator and filter regulator) Size 3 HZE3Z310R	L-bracket (for filter and lubricator) Size 3 HZE3Z310F	Threaded adaptor for pressure gauge Size 3 G1/4 HZE7Z490 Screw torque: Max 0,6 Nm

Filter regulator accessories

HZE3Z600SS	HZE3Z600SA	HZE3Z664
Bowl with semi-automatic drain Size 3 HZE3Z600SS	Bowl with automatic drain Size 3 HZE3Z600SA	Filter element 40 µm Size 3 HZE3Z664

Regulator and filter regulator accessories

HZE3Z602	HZE3Z658	HZE3Z603	HZE3Z610
Knob Size 3 HZE3Z602	Regulator spring Size 3 HZE3Z658 Pressure adjustment 0,5 ÷ 8,5	Ring nut for panel Size 3 HZE3Z603	Diaphragm kit Size 3 HZE3Z610 with relieving

Lubricator accessories

HZE3Z601	HZE3Z470
Standard bowl Size 3 HZE3Z601	Lubricator transparent dome Size 3 HZE3Z470

- HZ9N
- HZ9NP50
- HZ9N12



See ACCESSORIES chapter

CHARACTERISTICS

Ambient temperature	2 ÷ 65°C
Fluid	filtered compressed air 5 µm
Working pressure	10 bar
Max pressure	15 bar
Sizes	1 - 2
Body	die-cast aluminium
Bowl	polycarbonate
Bowl guard	technopolymer
Filter element	high efficiency borosilicate glass microfiber filter
Condensation drain	manual (standard) semi-automatic/automatic (on request)
Mounting position	vertical, a 5 µm pre-filter is to be installed upstream

Filtration grades available:

- 0,3 µm and residual oil 0,1 mg/m³ (ISO 8573 - 1: 2010 class 2.7.2)
- 0,01 µm and residual oil 0,01 mg/m³ (ISO 8573 - 1: 2010 class 1.7.1)



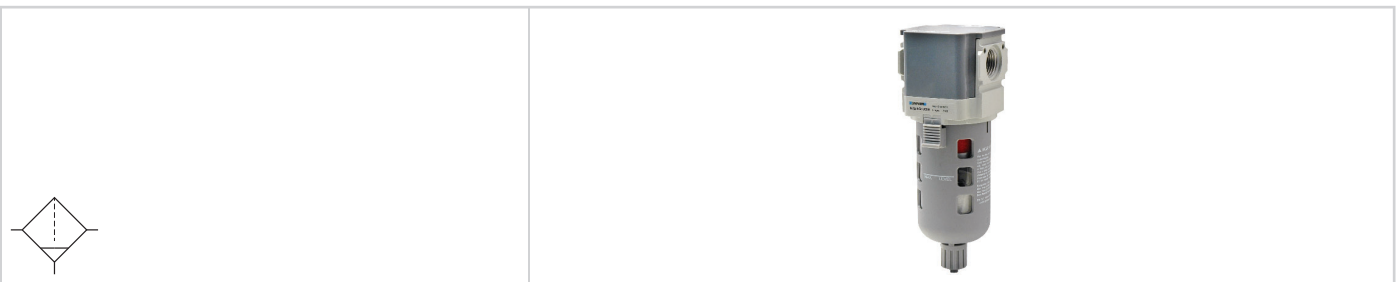
CODIFICATION KEY

H	Z	E	1	G	1	0	G		B	
1	2	3	4	5	6	7				

1 Series	2 Size	3 Model	4 Thread
HZE = Air treatment unit with standard manual drain	1 = Size 1 2 = Size 2	G = Coalescence	10G = G3/8 (Size 1) 15G = G1/2 (Size 1-2)

5 Option	6 Version	7 ATEX option
A = Automatic drain S = Semi-automatic drain	B = Filter element 0,01 µm (red color) C = Filter element 0,3 µm (green color)	X = Atex (upon request) See ATEX Catalogue for types and versions

Coalescence purifier filter



Size	1	2
Connections	3/8 - 1/2	1/2
Filtration rate (µm)	0,3	0,01
Residual oil content (mg/m ³)	0,1	0,01
Nominal flow rate with manual drain (NI/min) ^(A)	600	1000
Nominal flow rate with automatic drain (NI/min) ^(A)	450	750
Condensation drain capacity (cm ³)	45	80
Type of mounting	vertical	vertical
Weight (Kg)	0,31	0,55

(A) = Inlet pressure 7 bar

Note: Install a 5 µm pre-filter prior to the coalescence purifier filter.
It is recommended to replace the filter element when the pressure drop (ΔP) exceeds 0,7 bar

HZE1/2Z200

HZE1/2Z300



T-bracket assembly kit
Size 1 HZE1Z210
Size 2 HZE2Z210

C-bracket
Size 1 HZE1Z300
Size 2 HZE2Z300

HZE1/2Z600

HZE1/2Z600SS

HZE7Z400

HZE1/2Z673L

HZE1/2Z671L



Standard bowl with manual drain
Size 1 HZE1Z600
Size 2 HZE2Z600

Bowl with semi-automatic drain
Size 1 HZE1Z600SS
Size 2 HZE2Z600SS

Automatic drain
Size 1-2 HZE7Z400

Filter element for manual and semi-automatic drain 0,3 µm
Size 1 HZE1Z673L
Size 2 HZE2Z673L

Filter element for manual and semi-automatic drain 0,01 µm
Size 1 HZE1Z671L
Size 2 HZE2Z671L

HZE1/2Z673C

HZE1/2Z671C



Filter element for automatic drain 0,3 µm
Size 1 HZE1Z673C
Size 2 HZE2Z673C

Filter element for automatic drain 0,01 µm
Size 1 HZE1Z671C
Size 2 HZE2Z671C

CHARACTERISTICS

Ambient temperature	2 ÷ 30°C
Fluid	filtered compressed and oil free air 0,01 µm
Working pressure	10 bar
Max pressure	15 bar
Sizes	1 - 2
Body	die-cast aluminium
Bowl	polycarbonate
Bowl guard	technopolymer
Filter element	activated carbon
Condensation drain	manual (standard)
Mounting position	vertical, 5 µm pre-filter and 0,01 µm coalescence purifier filter are to be installed upstream

Residual oil content 0,003 mg/m³ (ISO 8573 - 1: 2010 class 1.7.1)

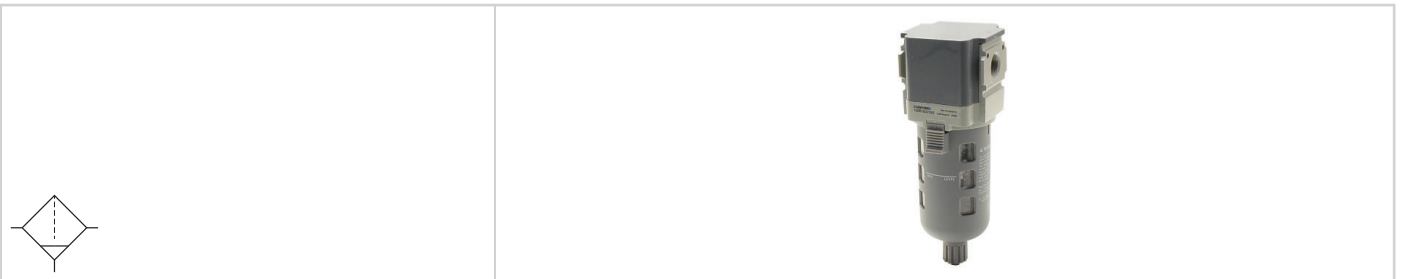


CODIFICATION KEY

H	Z	E	1	G	D	1	0	G	
1	2	3	4	5					

1 Series	2 Size	3 Model	4 Thread	5 ATEX option
HZE = Air treatment unit with standard manual drain	1 = Size 1 2 = Size 2	GD = Activated carbon	10G = G3/8 (Size 1) 15G = G1/2 (Size 1-2)	X = ATEX (upon request) See ATEX Catalogue for types and versions

Oil separator filter with activated carbon



Size	1	2
Connection	G3/8 - G1/2	G1/2
Residual oil content (mg/m ³)	0,003	0,003
Nominal flow rate with manual drain (NI/min) ^(A)	600	1000
Condensation drain capacity (cm ³)	45	80
Type of mounting	vertical	vertical
Weight (Kg)	0,31	0,55

(A) = Inlet pressure 7 bar

Note: install a 5 µm pre-filter and a 0,01 µm coalescence purifier filter prior to the oil separator filter with activated carbon. It is recommended to replace the filter element after every 1000 h of use.

HZE1Z200	HZE1/2Z210	HZE1/2Z300	HZE1/2Z600	HZE1/2Z674L
Assembly kit Size 1-2 HZE1Z200	T-bracket assembly kit Size 1 HZE1Z210 Size 2 HZE2Z210	C-bracket Size 1 HZE1Z300 Size 2 HZE2Z300	Standard bowl with manual drain Size 1 HZE1Z600 Size 2 HZE2Z600	Filter element with activated carbon Size 1 HZE1Z674L Size 2 HZE2Z674L

CHARACTERISTICS

Ambient temperature	-5 ÷ +60 °C
Fluid	compressed dry air, filtered and oil free
Working pressure	Max 10 bar
Connection	G1/4
Flow rate	1200 NI/min
Adjustment range	0,05 ÷ 2 bar
	0,05 ÷ 4 bar
	0,05 ÷ 8 bar
Sensitivity	≤ 0,2% (F.S.)
Repeatability	≤ 0,5% (F.S.)
Total air consumption	≤ 3 NI/min (a 7 bar) ≤ 4 NI/min (a 10 bar)
Pressure gauge connection	R1/8
Weight	regulator 310 g
	L-bracket 32 g
Body	aluminium
Membrane	NBR
Valve	stainless steel/brass

(F.S.) = Full-scale



CODIFICATION KEY

H	Z	R	P	3	0	0	8	G	A
1			2				3		

1 Series

HZRP30 = Precision regulator G1/4
(L-bracket standard supplied)

2 Connection

08G = G1/4

3 Adjusting field

A = 0,05 ÷ 2 bar
B = 0,05 ÷ 4 bar
C = 0,05 ÷ 8 bar

L-bracket



Standard supplied

HZ9P Pressure gauge



Connection R1/8
(to be ordered separately)

HZ9N Digital pressure switch



Connection R1/8
(to be ordered separately)

CHARACTERISTICS

Ambient temperature	-10 ÷ 50 °C
Fluid	filtered air, lubricated or not, neutral gases
Max pressure	10 bar
Pressure adjustment-relieving version	0,8 ÷ 8 bar
Connections	G1/4
Pressure gauge connection	R1/8
Nominal flow rate (NI/min)	320 NI/min
Body	aluminium
Knob	tecnopolymer
Bonnet	tecnopolymer
Spring	steel C85
Diaphragm	nitrile rubber and tecnopolymer



(A) = Different adjustment range upon request
 (B) = Inlet pressure 6 bar, outlet pressure 5 bar, Δp 1 bar

CODIFICATION KEY

H	Z	R	S	0	8	G	-	
1			2			3		

1 Series	2 Connections	3 Version
HZRS = Pressure Microregulators for air	08G = G1/4	_ = standard 1 ÷ 8 bar -2 = 0 ÷ 2 bar -4 = 0 ÷ 4 bar -6 = 0 ÷ 6 bar

HZE0Z603	HZE0Z310	HZRS65_
Ring nut for panel Technopolymer (included)	Regulator L-bracket Nickel-plated steel	Regulator spring Pressure adjustment HZRS652 0÷2 bar HZRS654 0÷4 bar HZRS656 0÷6 bar

Special version:
 Microregulator for high pressure
 HZRH08G

CHARACTERISTICS

	HZRE31	HZRE32	HZRE33
Ambient temperature	0 ÷ 50 °C		
Fluid	filtered compressed air 5 µm, inert gas, with or without lubrication		
Adjusting range	0÷1 bar 0÷5 bar 0÷9 bar		
Max pressure	10 bar (2 bar adjusting range 0 ÷ 1 bar)		
Min pressure	controlled pressure +1 bar		
Connections	G1/8	G1/4	G1/2
Pressure gauge connection	G1/8		
Nominal flow rate (NI/min)	300	1500	5000
Sensitivity	≤ ± 0,5% F.S.		
Linearity	≤ 1% F.S.		
Repeatability	≤ ± 0,5% F.S.		
Hysteresis	≤ 0,5% F.S.		
Weight	370 g	420 g	770 g

F.S. Full-span



CODIFICATION KEY

H	Z	R	E	3	2	0	8	G	C	B	B
1		2		3		4		5		6	

1 Series	2 Type	3 Thread	4 Adjusting range
HZRE = Electropneumatic proportional miniregulator	31 = Size 1 32 = Size 2 33 = Size 3	06G = G1/8 (size 1) 08G = G1/4 (size 2) 15G = G1/2 (size 3)	A = 0 ÷ 1 bar B = 0 ÷ 5 bar C = 0 ÷ 9 bar

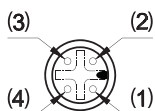
5 Input signal	6 Output signal
A = 4 ÷ 20 mA (0 ÷ 20 mA) B = 0 ÷ 10 V DC (0 ÷ 5 V DC) C = Preset 4 input ^(b)	A = 4 ÷ 20 mA B = 1 ÷ 5 V DC C = 24 V DC PNP D = 24 V DC NPN

(b) = Not available with output signal
Support and connector not included

ELECTRICAL CHARACTERISTICS

Voltage	24 V DC ± 10%	
Power consumption	< 6 W	
Protection degree	IP65	
Connections	M12A male connector 4 poles	
Input signal	Current	4 ÷ 20 mA 0 ÷ 20 mA
	Voltage	0 ÷ 10 V DC 0 ÷ 5 V DC
	Preset	4 input
Output signal	Analog	4 ÷ 20 mA/1 ÷ 5 V DC
	Digital	24 V DC PNP/NPN

M12A connector electrical connections



Pin No.	Cable	Analog signal	Preset 4 input
1	Red/Brown	+24 V DC	+ 24 V DC
2	White	input signal	input 1
3	Blue	0V	0V
4	Black	output signal	input 2

HZRE30300

HZRE30310

HZREM12L03D

HZREM12L03L



Horizontal bracket



Wall bracket



M12 in-line connector
3 m cable














M12 90° connector
3 m cable

5

Accessories















	Push-in Fittings	HA HAR HB	2 5 6
	Fittings with pneumatic functions	HC	9
	Standard Fittings	HD	13
	Push-on Fittings	HGC	16
	Olive Fittings	HGO	18
	Quick Couplings	HGU	19
	Tubes	HE/HF	20
	Air/Oil reservoir	AM4	21
	Shock absorbers	YDA/YDR	22
	Pressure switch	HZ9	23
	Vacuum switch	HZ9N	24
		HZ9N_50	25
		HZ9NP40	26
		HZ9N12	27
	Magnetic and Electronic Sensors	DF/DH	28/29
		DF-T	30
		DF-RW	31
		DF-MS	32
		DF-MA	33

CHARACTERISTICS

Temperature	-10 ÷ 80 °C (based on the type of tube)
Fluid	compressed air, vacuum
Working pressure	-0,99 ÷ 10 bar
Body	technopolymer
Fixing elements	nickel-plated brass with O-ring in NBR for parallel thread version (standard) teflon coating for taper thread version (upon request)
Clamp	stainless steel
Release ring	technopolymer
Application fields	pneumatic circuits
Recommended hoses	polyamide PA 10.12, polyurethane Sh.A98, co-polyurethane Sh.55D

5

<p>HA02 Smooth body straight parallel male</p>  <table border="1"> <thead> <tr> <th></th> <th>Ø</th> <th>connection</th> </tr> </thead> <tbody> <tr><td>HA0204M5</td><td>4</td><td>M5</td></tr> <tr><td>HA0206M5</td><td>6</td><td>M5</td></tr> <tr><td>HA020418</td><td>4</td><td>G1/8</td></tr> <tr><td>HA020618</td><td>6</td><td>G1/8</td></tr> <tr><td>HA020818</td><td>8</td><td>G1/8</td></tr> <tr><td>HA020414</td><td>4</td><td>G1/4</td></tr> <tr><td>HA020614</td><td>6</td><td>G1/4</td></tr> <tr><td>HA020814</td><td>8</td><td>G1/4</td></tr> <tr><td>HA021014</td><td>10</td><td>G1/4</td></tr> <tr><td>HA020838</td><td>8</td><td>G3/8</td></tr> <tr><td>HA021038</td><td>10</td><td>G3/8</td></tr> <tr><td>HA021238</td><td>12</td><td>G3/8</td></tr> <tr><td>HA021012</td><td>10</td><td>G1/2</td></tr> <tr><td>HA021212</td><td>12</td><td>G1/2</td></tr> </tbody> </table>		Ø	connection	HA0204M5	4	M5	HA0206M5	6	M5	HA020418	4	G1/8	HA020618	6	G1/8	HA020818	8	G1/8	HA020414	4	G1/4	HA020614	6	G1/4	HA020814	8	G1/4	HA021014	10	G1/4	HA020838	8	G3/8	HA021038	10	G3/8	HA021238	12	G3/8	HA021012	10	G1/2	HA021212	12	G1/2	<p>HA04 Straight parallel male</p>  <table border="1"> <thead> <tr> <th></th> <th>Ø</th> <th>connection</th> </tr> </thead> <tbody> <tr><td>HA0404M5</td><td>4</td><td>M5</td></tr> <tr><td>HA0406M5</td><td>6</td><td>M5</td></tr> <tr><td>HA040418</td><td>4</td><td>G1/8</td></tr> <tr><td>HA040618</td><td>6</td><td>G1/8</td></tr> <tr><td>HA040818</td><td>8</td><td>G1/8</td></tr> <tr><td>HA040414</td><td>4</td><td>G1/4</td></tr> <tr><td>HA040614</td><td>6</td><td>G1/4</td></tr> <tr><td>HA040814</td><td>8</td><td>G1/4</td></tr> <tr><td>HA041014</td><td>10</td><td>G1/4</td></tr> <tr><td>HA040838</td><td>8</td><td>G3/8</td></tr> <tr><td>HA041038</td><td>10</td><td>G3/8</td></tr> <tr><td>HA041238</td><td>12</td><td>G3/8</td></tr> <tr><td>HA041012</td><td>10</td><td>G1/2</td></tr> <tr><td>HA041212</td><td>12</td><td>G1/2</td></tr> </tbody> </table>		Ø	connection	HA0404M5	4	M5	HA0406M5	6	M5	HA040418	4	G1/8	HA040618	6	G1/8	HA040818	8	G1/8	HA040414	4	G1/4	HA040614	6	G1/4	HA040814	8	G1/4	HA041014	10	G1/4	HA040838	8	G3/8	HA041038	10	G3/8	HA041238	12	G3/8	HA041012	10	G1/2	HA041212	12	G1/2	<p>HA06 Plastic straight parallel male</p>  <table border="1"> <thead> <tr> <th></th> <th>Ø</th> <th>connection</th> </tr> </thead> <tbody> <tr><td>HA060618</td><td>6</td><td>G1/8</td></tr> <tr><td>HA060818</td><td>8</td><td>G1/8</td></tr> <tr><td>HA060614</td><td>6</td><td>G1/4</td></tr> <tr><td>HA060814</td><td>8</td><td>G1/4</td></tr> <tr><td>HA061014</td><td>10</td><td>G1/4</td></tr> <tr><td>HA060838</td><td>8</td><td>G3/8</td></tr> <tr><td>HA061038</td><td>10</td><td>G3/8</td></tr> <tr><td>HA061238</td><td>12</td><td>G3/8</td></tr> <tr><td>HA061012</td><td>10</td><td>G1/2</td></tr> <tr><td>HA061212</td><td>12</td><td>G1/2</td></tr> </tbody> </table>		Ø	connection	HA060618	6	G1/8	HA060818	8	G1/8	HA060614	6	G1/4	HA060814	8	G1/4	HA061014	10	G1/4	HA060838	8	G3/8	HA061038	10	G3/8	HA061238	12	G3/8	HA061012	10	G1/2	HA061212	12	G1/2									
	Ø	connection																																																																																																																																				
HA0204M5	4	M5																																																																																																																																				
HA0206M5	6	M5																																																																																																																																				
HA020418	4	G1/8																																																																																																																																				
HA020618	6	G1/8																																																																																																																																				
HA020818	8	G1/8																																																																																																																																				
HA020414	4	G1/4																																																																																																																																				
HA020614	6	G1/4																																																																																																																																				
HA020814	8	G1/4																																																																																																																																				
HA021014	10	G1/4																																																																																																																																				
HA020838	8	G3/8																																																																																																																																				
HA021038	10	G3/8																																																																																																																																				
HA021238	12	G3/8																																																																																																																																				
HA021012	10	G1/2																																																																																																																																				
HA021212	12	G1/2																																																																																																																																				
	Ø	connection																																																																																																																																				
HA0404M5	4	M5																																																																																																																																				
HA0406M5	6	M5																																																																																																																																				
HA040418	4	G1/8																																																																																																																																				
HA040618	6	G1/8																																																																																																																																				
HA040818	8	G1/8																																																																																																																																				
HA040414	4	G1/4																																																																																																																																				
HA040614	6	G1/4																																																																																																																																				
HA040814	8	G1/4																																																																																																																																				
HA041014	10	G1/4																																																																																																																																				
HA040838	8	G3/8																																																																																																																																				
HA041038	10	G3/8																																																																																																																																				
HA041238	12	G3/8																																																																																																																																				
HA041012	10	G1/2																																																																																																																																				
HA041212	12	G1/2																																																																																																																																				
	Ø	connection																																																																																																																																				
HA060618	6	G1/8																																																																																																																																				
HA060818	8	G1/8																																																																																																																																				
HA060614	6	G1/4																																																																																																																																				
HA060814	8	G1/4																																																																																																																																				
HA061014	10	G1/4																																																																																																																																				
HA060838	8	G3/8																																																																																																																																				
HA061038	10	G3/8																																																																																																																																				
HA061238	12	G3/8																																																																																																																																				
HA061012	10	G1/2																																																																																																																																				
HA061212	12	G1/2																																																																																																																																				
<p>HA07 Straight female</p>  <table border="1"> <thead> <tr> <th></th> <th>Ø</th> <th>connection</th> </tr> </thead> <tbody> <tr><td>HA070418</td><td>4</td><td>G1/8</td></tr> <tr><td>HA070618</td><td>6</td><td>G1/8</td></tr> <tr><td>HA070818</td><td>8</td><td>G1/8</td></tr> <tr><td>HA070614</td><td>6</td><td>G1/4</td></tr> <tr><td>HA070814</td><td>8</td><td>G1/4</td></tr> <tr><td>HA071014</td><td>10</td><td>G1/4</td></tr> <tr><td>HA070838</td><td>8</td><td>G3/8</td></tr> <tr><td>HA071038</td><td>10</td><td>G3/8</td></tr> <tr><td>HA071238</td><td>12</td><td>G3/8</td></tr> <tr><td>HA071212</td><td>12</td><td>G1/2</td></tr> </tbody> </table>		Ø	connection	HA070418	4	G1/8	HA070618	6	G1/8	HA070818	8	G1/8	HA070614	6	G1/4	HA070814	8	G1/4	HA071014	10	G1/4	HA070838	8	G3/8	HA071038	10	G3/8	HA071238	12	G3/8	HA071212	12	G1/2	<p>HA08 Swivel elbow female</p>  <table border="1"> <thead> <tr> <th></th> <th>Ø</th> <th>connection</th> </tr> </thead> <tbody> <tr><td>HA080418</td><td>4</td><td>G1/8</td></tr> <tr><td>HA080618</td><td>6</td><td>G1/8</td></tr> <tr><td>HA080818</td><td>8</td><td>G1/8</td></tr> <tr><td>HA080614</td><td>6</td><td>G1/4</td></tr> <tr><td>HA080814</td><td>8</td><td>G1/4</td></tr> <tr><td>HA081014</td><td>10</td><td>G1/4</td></tr> <tr><td>HA080838</td><td>8</td><td>G3/8</td></tr> <tr><td>HA081038</td><td>10</td><td>G3/8</td></tr> <tr><td>HA081238</td><td>12</td><td>G3/8</td></tr> <tr><td>HA081212</td><td>12</td><td>G1/2</td></tr> </tbody> </table>		Ø	connection	HA080418	4	G1/8	HA080618	6	G1/8	HA080818	8	G1/8	HA080614	6	G1/4	HA080814	8	G1/4	HA081014	10	G1/4	HA080838	8	G3/8	HA081038	10	G3/8	HA081238	12	G3/8	HA081212	12	G1/2	<p>HA10B Low elbow</p>  <table border="1"> <thead> <tr> <th></th> <th>Ø</th> <th>connection</th> </tr> </thead> <tbody> <tr><td>HA10B04M5</td><td>4</td><td>M5</td></tr> <tr><td>HA10B06M5</td><td>6</td><td>M5</td></tr> <tr><td>HA10B0418</td><td>4</td><td>G1/8</td></tr> <tr><td>HA10B0618</td><td>6</td><td>G1/8</td></tr> <tr><td>HA10B0818</td><td>8</td><td>G1/8</td></tr> <tr><td>HA10B0414</td><td>4</td><td>G1/4</td></tr> <tr><td>HA10B0614</td><td>6</td><td>G1/4</td></tr> <tr><td>HA10B0814</td><td>8</td><td>G1/4</td></tr> <tr><td>HA10B1014</td><td>10</td><td>G1/4</td></tr> <tr><td>HA10B0838</td><td>8</td><td>G3/8</td></tr> <tr><td>HA10B1038</td><td>10</td><td>G3/8</td></tr> <tr><td>HA10B1238</td><td>12</td><td>G3/8</td></tr> <tr><td>HA10B1012</td><td>10</td><td>G1/2</td></tr> <tr><td>HA10B1212</td><td>12</td><td>G1/2</td></tr> </tbody> </table>		Ø	connection	HA10B04M5	4	M5	HA10B06M5	6	M5	HA10B0418	4	G1/8	HA10B0618	6	G1/8	HA10B0818	8	G1/8	HA10B0414	4	G1/4	HA10B0614	6	G1/4	HA10B0814	8	G1/4	HA10B1014	10	G1/4	HA10B0838	8	G3/8	HA10B1038	10	G3/8	HA10B1238	12	G3/8	HA10B1012	10	G1/2	HA10B1212	12	G1/2																					
	Ø	connection																																																																																																																																				
HA070418	4	G1/8																																																																																																																																				
HA070618	6	G1/8																																																																																																																																				
HA070818	8	G1/8																																																																																																																																				
HA070614	6	G1/4																																																																																																																																				
HA070814	8	G1/4																																																																																																																																				
HA071014	10	G1/4																																																																																																																																				
HA070838	8	G3/8																																																																																																																																				
HA071038	10	G3/8																																																																																																																																				
HA071238	12	G3/8																																																																																																																																				
HA071212	12	G1/2																																																																																																																																				
	Ø	connection																																																																																																																																				
HA080418	4	G1/8																																																																																																																																				
HA080618	6	G1/8																																																																																																																																				
HA080818	8	G1/8																																																																																																																																				
HA080614	6	G1/4																																																																																																																																				
HA080814	8	G1/4																																																																																																																																				
HA081014	10	G1/4																																																																																																																																				
HA080838	8	G3/8																																																																																																																																				
HA081038	10	G3/8																																																																																																																																				
HA081238	12	G3/8																																																																																																																																				
HA081212	12	G1/2																																																																																																																																				
	Ø	connection																																																																																																																																				
HA10B04M5	4	M5																																																																																																																																				
HA10B06M5	6	M5																																																																																																																																				
HA10B0418	4	G1/8																																																																																																																																				
HA10B0618	6	G1/8																																																																																																																																				
HA10B0818	8	G1/8																																																																																																																																				
HA10B0414	4	G1/4																																																																																																																																				
HA10B0614	6	G1/4																																																																																																																																				
HA10B0814	8	G1/4																																																																																																																																				
HA10B1014	10	G1/4																																																																																																																																				
HA10B0838	8	G3/8																																																																																																																																				
HA10B1038	10	G3/8																																																																																																																																				
HA10B1238	12	G3/8																																																																																																																																				
HA10B1012	10	G1/2																																																																																																																																				
HA10B1212	12	G1/2																																																																																																																																				
<p>HA12B Extended swivel low elbow parallel male</p>  <table border="1"> <thead> <tr> <th></th> <th>Ø</th> <th>connection</th> </tr> </thead> <tbody> <tr><td>HA12B04M5</td><td>4</td><td>M5</td></tr> <tr><td>HA12B06M5</td><td>6</td><td>M5</td></tr> <tr><td>HA12B0418</td><td>4</td><td>G1/8</td></tr> <tr><td>HA12B0618</td><td>6</td><td>G1/8</td></tr> <tr><td>HA12B0818</td><td>8</td><td>G1/8</td></tr> <tr><td>HA12B0414</td><td>4</td><td>G1/4</td></tr> <tr><td>HA12B0614</td><td>6</td><td>G1/4</td></tr> <tr><td>HA12B0814</td><td>8</td><td>G1/4</td></tr> <tr><td>HA12B1014</td><td>10</td><td>G1/4</td></tr> <tr><td>HA12B0638</td><td>6</td><td>G3/8</td></tr> <tr><td>HA12B0838</td><td>8</td><td>G3/8</td></tr> <tr><td>HA12B1038</td><td>10</td><td>G3/8</td></tr> <tr><td>HA12B1238</td><td>12</td><td>G3/8</td></tr> <tr><td>HA12B1012</td><td>10</td><td>G1/2</td></tr> <tr><td>HA12B1212</td><td>12</td><td>G1/2</td></tr> </tbody> </table>		Ø	connection	HA12B04M5	4	M5	HA12B06M5	6	M5	HA12B0418	4	G1/8	HA12B0618	6	G1/8	HA12B0818	8	G1/8	HA12B0414	4	G1/4	HA12B0614	6	G1/4	HA12B0814	8	G1/4	HA12B1014	10	G1/4	HA12B0638	6	G3/8	HA12B0838	8	G3/8	HA12B1038	10	G3/8	HA12B1238	12	G3/8	HA12B1012	10	G1/2	HA12B1212	12	G1/2	<p>HA14B Low lateral Tee male</p>  <table border="1"> <thead> <tr> <th></th> <th>Ø</th> <th>connection</th> </tr> </thead> <tbody> <tr><td>HA14B04M5</td><td>4</td><td>M5</td></tr> <tr><td>HA14B06M5</td><td>6</td><td>M5</td></tr> <tr><td>HA14B0418</td><td>4</td><td>G1/8</td></tr> <tr><td>HA14B0618</td><td>6</td><td>G1/8</td></tr> <tr><td>HA14B0818</td><td>8</td><td>G1/8</td></tr> <tr><td>HA14B0614</td><td>6</td><td>G1/4</td></tr> <tr><td>HA14B0814</td><td>8</td><td>G1/4</td></tr> <tr><td>HA14B1014</td><td>10</td><td>G1/4</td></tr> <tr><td>HA14B0838</td><td>8</td><td>G3/8</td></tr> <tr><td>HA14B1038</td><td>10</td><td>G3/8</td></tr> <tr><td>HA14B1238</td><td>12</td><td>G3/8</td></tr> <tr><td>HA14B1012</td><td>10</td><td>G1/2</td></tr> <tr><td>HA14B1212</td><td>12</td><td>G1/2</td></tr> </tbody> </table>		Ø	connection	HA14B04M5	4	M5	HA14B06M5	6	M5	HA14B0418	4	G1/8	HA14B0618	6	G1/8	HA14B0818	8	G1/8	HA14B0614	6	G1/4	HA14B0814	8	G1/4	HA14B1014	10	G1/4	HA14B0838	8	G3/8	HA14B1038	10	G3/8	HA14B1238	12	G3/8	HA14B1012	10	G1/2	HA14B1212	12	G1/2	<p>HA16B Low central Tee male</p>  <table border="1"> <thead> <tr> <th></th> <th>Ø</th> <th>connection</th> </tr> </thead> <tbody> <tr><td>HA16B04M5</td><td>4</td><td>M5</td></tr> <tr><td>HA16B06M5</td><td>6</td><td>M5</td></tr> <tr><td>HA16B0418</td><td>4</td><td>G1/8</td></tr> <tr><td>HA16B0618</td><td>6</td><td>G1/8</td></tr> <tr><td>HA16B0818</td><td>8</td><td>G1/8</td></tr> <tr><td>HA16B0614</td><td>6</td><td>G1/4</td></tr> <tr><td>HA16B0814</td><td>8</td><td>G1/4</td></tr> <tr><td>HA16B1014</td><td>10</td><td>G1/4</td></tr> <tr><td>HA16B0838</td><td>8</td><td>G3/8</td></tr> <tr><td>HA16B1038</td><td>10</td><td>G3/8</td></tr> <tr><td>HA16B1238</td><td>12</td><td>G3/8</td></tr> <tr><td>HA16B1012</td><td>10</td><td>G1/2</td></tr> <tr><td>HA16B1212</td><td>12</td><td>G1/2</td></tr> </tbody> </table>		Ø	connection	HA16B04M5	4	M5	HA16B06M5	6	M5	HA16B0418	4	G1/8	HA16B0618	6	G1/8	HA16B0818	8	G1/8	HA16B0614	6	G1/4	HA16B0814	8	G1/4	HA16B1014	10	G1/4	HA16B0838	8	G3/8	HA16B1038	10	G3/8	HA16B1238	12	G3/8	HA16B1012	10	G1/2	HA16B1212	12	G1/2
	Ø	connection																																																																																																																																				
HA12B04M5	4	M5																																																																																																																																				
HA12B06M5	6	M5																																																																																																																																				
HA12B0418	4	G1/8																																																																																																																																				
HA12B0618	6	G1/8																																																																																																																																				
HA12B0818	8	G1/8																																																																																																																																				
HA12B0414	4	G1/4																																																																																																																																				
HA12B0614	6	G1/4																																																																																																																																				
HA12B0814	8	G1/4																																																																																																																																				
HA12B1014	10	G1/4																																																																																																																																				
HA12B0638	6	G3/8																																																																																																																																				
HA12B0838	8	G3/8																																																																																																																																				
HA12B1038	10	G3/8																																																																																																																																				
HA12B1238	12	G3/8																																																																																																																																				
HA12B1012	10	G1/2																																																																																																																																				
HA12B1212	12	G1/2																																																																																																																																				
	Ø	connection																																																																																																																																				
HA14B04M5	4	M5																																																																																																																																				
HA14B06M5	6	M5																																																																																																																																				
HA14B0418	4	G1/8																																																																																																																																				
HA14B0618	6	G1/8																																																																																																																																				
HA14B0818	8	G1/8																																																																																																																																				
HA14B0614	6	G1/4																																																																																																																																				
HA14B0814	8	G1/4																																																																																																																																				
HA14B1014	10	G1/4																																																																																																																																				
HA14B0838	8	G3/8																																																																																																																																				
HA14B1038	10	G3/8																																																																																																																																				
HA14B1238	12	G3/8																																																																																																																																				
HA14B1012	10	G1/2																																																																																																																																				
HA14B1212	12	G1/2																																																																																																																																				
	Ø	connection																																																																																																																																				
HA16B04M5	4	M5																																																																																																																																				
HA16B06M5	6	M5																																																																																																																																				
HA16B0418	4	G1/8																																																																																																																																				
HA16B0618	6	G1/8																																																																																																																																				
HA16B0818	8	G1/8																																																																																																																																				
HA16B0614	6	G1/4																																																																																																																																				
HA16B0814	8	G1/4																																																																																																																																				
HA16B1014	10	G1/4																																																																																																																																				
HA16B0838	8	G3/8																																																																																																																																				
HA16B1038	10	G3/8																																																																																																																																				
HA16B1238	12	G3/8																																																																																																																																				
HA16B1012	10	G1/2																																																																																																																																				
HA16B1212	12	G1/2																																																																																																																																				
<p>HA18 Y parallel male</p>  <table border="1"> <thead> <tr> <th></th> <th>Ø</th> <th>connection</th> </tr> </thead> <tbody> <tr><td>HA1804M5</td><td>4</td><td>M5</td></tr> <tr><td>HA1806M5</td><td>6</td><td>M5</td></tr> <tr><td>HA180418</td><td>4</td><td>G1/8</td></tr> <tr><td>HA180618</td><td>6</td><td>G1/8</td></tr> <tr><td>HA180818</td><td>8</td><td>G1/8</td></tr> <tr><td>HA180614</td><td>6</td><td>G1/4</td></tr> <tr><td>HA180814</td><td>8</td><td>G1/4</td></tr> <tr><td>HA181014</td><td>10</td><td>G1/4</td></tr> <tr><td>HA180838</td><td>8</td><td>G3/8</td></tr> <tr><td>HA181038</td><td>10</td><td>G3/8</td></tr> <tr><td>HA181238</td><td>12</td><td>G3/8</td></tr> <tr><td>HA181012</td><td>10</td><td>G1/2</td></tr> <tr><td>HA181212</td><td>12</td><td>G1/2</td></tr> </tbody> </table>		Ø	connection	HA1804M5	4	M5	HA1806M5	6	M5	HA180418	4	G1/8	HA180618	6	G1/8	HA180818	8	G1/8	HA180614	6	G1/4	HA180814	8	G1/4	HA181014	10	G1/4	HA180838	8	G3/8	HA181038	10	G3/8	HA181238	12	G3/8	HA181012	10	G1/2	HA181212	12	G1/2	<p>HA19 Intermediate straight</p>  <table border="1"> <thead> <tr> <th></th> <th>Ø1</th> <th>Ø2</th> </tr> </thead> <tbody> <tr><td>HA190400</td><td>4</td><td>4</td></tr> <tr><td>HA190600</td><td>6</td><td>6</td></tr> <tr><td>HA190604</td><td>6</td><td>4</td></tr> <tr><td>HA190800</td><td>8</td><td>8</td></tr> <tr><td>HA190806</td><td>8</td><td>6</td></tr> <tr><td>HA191000</td><td>10</td><td>10</td></tr> <tr><td>HA191008</td><td>10</td><td>8</td></tr> <tr><td>HA191200</td><td>12</td><td>12</td></tr> <tr><td>HA191210</td><td>12</td><td>10</td></tr> </tbody> </table>		Ø1	Ø2	HA190400	4	4	HA190600	6	6	HA190604	6	4	HA190800	8	8	HA190806	8	6	HA191000	10	10	HA191008	10	8	HA191200	12	12	HA191210	12	10	<p>HA20 Intermediate elbow</p>  <table border="1"> <thead> <tr> <th></th> <th>Ø</th> </tr> </thead> <tbody> <tr><td>HA200400</td><td>4</td></tr> <tr><td>HA200600</td><td>6</td></tr> <tr><td>HA200800</td><td>8</td></tr> <tr><td>HA201000</td><td>10</td></tr> <tr><td>HA201200</td><td>12</td></tr> </tbody> </table>		Ø	HA200400	4	HA200600	6	HA200800	8	HA201000	10	HA201200	12																																																
	Ø	connection																																																																																																																																				
HA1804M5	4	M5																																																																																																																																				
HA1806M5	6	M5																																																																																																																																				
HA180418	4	G1/8																																																																																																																																				
HA180618	6	G1/8																																																																																																																																				
HA180818	8	G1/8																																																																																																																																				
HA180614	6	G1/4																																																																																																																																				
HA180814	8	G1/4																																																																																																																																				
HA181014	10	G1/4																																																																																																																																				
HA180838	8	G3/8																																																																																																																																				
HA181038	10	G3/8																																																																																																																																				
HA181238	12	G3/8																																																																																																																																				
HA181012	10	G1/2																																																																																																																																				
HA181212	12	G1/2																																																																																																																																				
	Ø1	Ø2																																																																																																																																				
HA190400	4	4																																																																																																																																				
HA190600	6	6																																																																																																																																				
HA190604	6	4																																																																																																																																				
HA190800	8	8																																																																																																																																				
HA190806	8	6																																																																																																																																				
HA191000	10	10																																																																																																																																				
HA191008	10	8																																																																																																																																				
HA191200	12	12																																																																																																																																				
HA191210	12	10																																																																																																																																				
	Ø																																																																																																																																					
HA200400	4																																																																																																																																					
HA200600	6																																																																																																																																					
HA200800	8																																																																																																																																					
HA201000	10																																																																																																																																					
HA201200	12																																																																																																																																					

HA21
Intermediate lateral Tee



	Ø1	Ø2
HA210400	4	4
HA210600	6	6
HA210800	8	8
HA211000	10	10
HA211200	12	12
HA211008	10	8
HA210810	8	10

HA22
Intermediate cross



	Ø
HA220400	4
HA220600	6
HA220800	8
HA221000	10
HA221200	12

HA23
Intermediate Y connector



	Ø1	Ø2
HA230404	4	4
HA230604	6	4
HA230606	6	6
HA230806	8	6
HA230808	8	8
HA231008	10	8
HA231010	10	10
HA231210	12	10
HA231212	12	12

HA24
Reducing stem



	Ø1	Ø2
HA240406	4	6
HA240408	4	8
HA240608	6	8
HA240610	6	10
HA240810	8	10
HA240812	8	12
HA241012	10	12

HA25
Y connector with male stem




	Ø
HA250400	4
HA250600	6
HA250800	8
HA251000	10
HA251200	12

HA26
Plug




	Ø
HA260400	4
HA260600	6
HA260800	8
HA261000	10
HA261200	12

HA27
Swivel banjo connector (parallel male thread) with wrench head



	Ø	connection
HA2704M5	4	M5
HA2706M5	6	M5
HA270418	4	G1/8
HA270618	6	G1/8
HA270818	8	G1/8
HA270614	6	G1/4
HA270814	8	G1/4
HA271014	10	G1/4
HA270838	8	G3/8
HA271038	10	G3/8
HA271238	12	G3/8
HA271012	10	G1/2
HA271212	12	G1/2

HA28
Swivel banjo connector parallel male-female




	Ø	connection
HA2804M5	4	M5
HA2806M5	6	M5
HA280418	4	G1/8
HA280618	6	G1/8
HA280818	8	G1/8
HA280614	6	G1/4
HA280814	8	G1/4
HA281014	10	G1/4
HA280838	8	G3/8
HA281038	10	G3/8
HA281238	12	G3/8
HA281012	10	G1/2
HA281212	12	G1/2

HA29
Triple branch lateral Tee




	Ø
HA290400	4
HA290600	6
HA290800	8

HA30
Triple branch lateral Tee




	Ø1	Ø2
HA300604	6	4
HA300804	8	4
HA300806	8	6
HA301006	10	6
HA301008	10	8

HA31
Triple branch lateral Tee male thread



	Ø1	Ø2	connection
HA314618	6	4	G1/8
HA314814	8	4	G1/4
HA316814	8	6	G1/4
HA318138	10	8	G3/8
HA318112	10	8	G1/2

HA32
Triple branch lateral Tee male thread




	Ø	connection
HA320418	4	G1/8
HA320618	6	G1/8
HA320818	8	G1/8
HA320414	4	G1/4
HA320614	6	G1/4
HA320814	8	G1/4
HA320638	6	G3/8
HA320838	8	G3/8

HA33
Bulkhead connector



	Ø
HA330004	4
HA330006	6
HA330008	8
HA330010	10
HA330012	12

HA34
Threaded bulkhead connector



	Ø	connection
HA340418	4	G1/8
HA340618	6	G1/8
HA340818	8	G1/8
HA340414	4	G1/4
HA340614	6	G1/4
HA340814	8	G1/4
HA341014	10	G1/4
HA340838	8	G3/8
HA341038	10	G3/8
HA341238	12	G3/8
HA341012	10	G1/2
HA341212	12	G1/2

HA35
Elbow bulkhead connector



	Ø
HA350004	4
HA350006	6
HA350008	8
HA350010	10
HA350012	12

■ **HA38**
Stem elbow



	Ø
HA380400	4
HA380600	6
HA380800	8
HA381000	10
HA381200	12

■ **HA41**
Swivel banjo connector (parallel thread) with allen head



	Ø	connection
HA410418	4	G1/8
HA410618	6	G1/8
HA410818	8	G1/8
HA410414	4	G1/4
HA410614	6	G1/4
HA410814	8	G1/4
HA411014	10	G1/4
HA411214	12	G1/4
HA410438	4	G3/8
HA410638	6	G3/8
HA410838	8	G3/8
HA411038	10	G3/8
HA411238	12	G3/8
HA411012	10	G1/2
HA411212	12	G1/2

■ **HA42**
Double banjo connector (parallel thread) with allen head



	Ø	connection
HA420418	4	G1/8
HA420618	6	G1/8
HA420818	8	G1/8
HA420414	4	G1/4
HA420614	6	G1/4
HA420814	8	G1/4
HA421014	10	G1/4
HA421214	12	G1/4
HA420438	4	G3/8
HA420638	6	G3/8
HA420838	8	G3/8
HA421038	10	G3/8
HA421238	12	G3/8
HA421012	10	G1/2
HA421212	12	G1/2

■ **HA43**
Triple banjo connector (parallel thread) with allen head



	Ø	connection
HA430418	4	G1/8
HA430618	6	G1/8
HA430818	8	G1/8
HA430414	4	G1/4
HA430614	6	G1/4
HA430814	8	G1/4
HA431014	10	G1/4
HA431214	12	G1/4
HA430438	4	G3/8
HA430638	6	G3/8
HA430838	8	G3/8
HA431038	10	G3/8
HA431238	12	G3/8
HA431012	10	G1/2
HA431212	12	G1/2

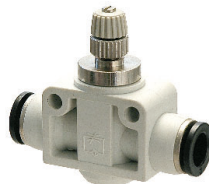
■ **Teflon coated taper thread**
(available upon request for all HA models)



■ **HC01/HC02**



■ **HC04**



■ **HC01T/HC02T**



■ **HC01L/HC02L**



Technopolymer flow regulators

CHARACTERISTICS

Temperature	-10 ÷ 80 °C
Fluid	compressed air, vacuum
Working pressure	-0,99 ÷ 9 bar
Body	technopolymer
Fixing elements	nickel-plated brass with O-ring in NBR
Clamp	stainless steel
Release ring	technopolymer
Application fields	pneumatic circuits
Recommended hoses	polyamide PA 10.12, polyurethane Sh.A98, co-polyurethane Sh.55D

HAR04
 Miniature straight male


	∅	connection
HAR0403M3	3	M3
HAR0404M3	4	M3
HAR0404M5	4	M5

HAR10B
 Miniature swivel elbow male


	∅	connection
HAR10B03M3	3	M3
HAR10B04M3	4	M3
HAR10B04M5	4	M5

HAR12B
 Miniature extended swivel elbow male


	∅	connection
HAR12B03M3	3	M3
HAR12B04M3	4	M3
HAR12B04M5	4	M5

HAR14B
 Miniature low lateral Tee male


	∅	connection
HAR14B03M3	3	M3
HAR14B04M3	4	M3
HAR14B04M5	4	M5

HAR16B
 Miniature low central Tee male


	∅	connection
HAR16B03M3	3	M3
HAR16B04M3	4	M3
HAR16B04M5	4	M5

HAR19
 Miniature intermediate straight


	∅
HAR190300	3
HAR190400	4

HAR20
 Miniature intermediate elbow


	∅
HAR200300	3
HAR200400	4

HAR21
 Miniature intermediate Tee


	∅
HAR210300	3
HAR210400	4

HAR23
 Miniature intermediate Y


	∅
HAR230300	3
HAR230400	4

CHARACTERISTICS

Temperature	-20 ÷ 80 °C
Fluid	compressed air, vacuum
Max pressure	16 bar (based on the type of tube)
Working pressure	-0,99 ÷ 10 bar
Body	nickel-plated brass
Fixing elements	nickel-plated brass with O-ring in NBR for parallel thread version (standard) Teflon coating for taper thread version (upon request)
Clamp	stainless steel AISI 316
Release ring	nickel-plated brass
Application fields	pneumatic circuits
Recommended hoses	polyamide PA 10.12, polyurethane Sh.A98, co-polyurethane Sh.55D

5

HB04

Straight parallel male



	Ø	connection		Ø	connection
HB0403M3	3	M3	HB040514	5	G1/4
HB0403M5	3	M5	HB040414	4	G1/4
HB0404M5	4	M5	HB041438	14	G3/8
HB0405M5	5	M5	HB041238	12	G3/8
HB0406M5	6	M5	HB041038	10	G3/8
HB041018	10	G1/8	HB040838	8	G3/8
HB040818	8	G1/8	HB040638	6	G3/8
HB040618	6	G1/8	HB041412	14	G1/2
HB040518	5	G1/8	HB041212	12	G1/2
HB040418	4	G1/8	HB041012	10	G1/2
HB041214	12	G1/4	HB040812	8	G1/2
HB041014	10	G1/4			
HB040814	8	G1/4			
HB040614	6	G1/4			

HB07

Straight female



	Ø	connection
HB0704M5	4	M5
HB070418	4	G1/8
HB070518	5	G1/8
HB070618	6	G1/8
HB070818	8	G1/8
HB071038	10	G3/8
HB070414	4	G1/4
HB070514	5	G1/4
HB070614	6	G1/4
HB070814	8	G1/4
HB071014	10	G1/4

HB08

Swivel elbow female



	Ø	connection
HB080418	4	G1/8
HB080618	6	G1/8
HB080818	8	G1/8
HB080414	4	G1/4
HB080614	6	G1/4
HB080814	8	G1/4

HB10

Swivel elbow male



	Ø	connection		Ø	connection
HB1004M5	4	M5	HB100838	8	G3/8
HB1005M5	5	M5	HB101038	10	G3/8
HB1006M5	6	M5	HB101238	12	G3/8
HB100418	4	G1/8	HB101438	14	G3/8
HB100518	5	G1/8	HB101012	10	G1/2
HB100618	6	G1/8	HB101212	12	G1/2
HB100818	8	G1/8	HB101412	14	G1/2
HB100414	4	G1/4			
HB100514	5	G1/4			
HB100614	6	G1/4			
HB100814	8	G1/4			
HB101014	10	G1/4			
HB101214	12	G1/4			
HB100638	6	G3/8			

HB12

Extended swivel elbow male



	Ø	connection
HB1204M5	4	M5
HB1206M5	6	M5
HB120418	4	G1/8
HB120618	6	G1/8
HB120818	8	G1/8
HB120414	4	G1/4
HB120614	6	G1/4
HB120814	8	G1/4
HB121014	10	G1/4

HB14

Lateral Tee parallel male



	Ø	connection
HB1404M5	4	M5
HB140418	4	G1/8
HB140618	6	G1/8
HB140818	8	G1/8
HB140414	4	G1/4
HB140614	6	G1/4
HB140814	8	G1/4
HB141014	10	G1/4
HB141214	12	G1/4
HB140838	8	G3/8
HB141038	10	G3/8
HB141238	12	G3/8
HB141412	14	G1/2

HB16

Central Tee male



	Ø	connection
HB1604M5	4	M5
HB160418	4	G1/8
HB160618	6	G1/8
HB160818	8	G1/8
HB160414	4	G1/4
HB160614	6	G1/4
HB160814	8	G1/4
HB161014	10	G1/4
HB161214	12	G1/4
HB160838	8	G3/8
HB161038	10	G3/8
HB161238	12	G3/8
HB161412	14	G1/2

HB19

Straight



	Ø1	Ø2
HB190303	3	3
HB190404	4	4
HB190505	5	5
HB190604	6	4
HB190606	6	6
HB190806	8	6
HB190808	8	8
HB191008	10	8
HB191010	10	10
HB191210	12	10
HB191212	12	12
HB191412	14	12
HB191414	14	14

■ **HB20**
Intermediate elbow



	Ø
HB200300	3
HB200400	4
HB200500	5
HB200600	6
HB200800	8
HB201000	10
HB201200	12
HB201400	14

■ **HB21**
Intermediate Tee



	Ø1	Ø2
HB210300	3	3
HB210400	4	4
HB210500	5	5
HB210600	6	6
HB210604	6	4
HB210800	8	8
HB210806	8	6
HB211000	10	10
HB211008	10	8
HB211200	12	12
HB211400	14	14

■ **HB24**
Reducing stem



	Ø1	Ø2		Ø1	Ø2
HB240405	4	5	HB240612	6	12
HB240406	4	6	HB240614	6	14
HB240408	4	8	HB240806	8	6
HB240412	4	12	HB240810	8	10
HB240414	4	14	HB240812	8	12
HB240506	5	6	HB240814	8	14
HB240508	5	8	HB241012	10	12
HB240604	6	4	HB241014	10	14
HB240608	6	8	HB241214	12	14
HB240610	6	10			

■ **HB26**
Plug



	Ø
HB260400	4
HB260500	5
HB260600	6
HB260800	8
HB261000	10
HB261200	12
HB261400	14

■ **HB27**
Swivel banjo connector (parallel thread) with allen head



	Ø	connection		Ø	connection
HB2703M3	3	M3	HB270614	6	G1/4
HB2703M5	3	M5	HB270814	8	G1/4
HB2704M5	4	M5	HB271014	10	G1/4
HB2705M5	5	M5	HB271214	12	G1/4
HB270418	4	G1/8	HB270838	8	G3/8
HB270518	5	G1/8	HB271038	10	G3/8
HB270618	6	G1/8	HB271238	12	G3/8
HB270818	8	G1/8			

■ **HB33**
Bulkhead connector



	Ø
HB330004	4
HB330005	5
HB330006	6
HB330008	8
HB330010	10
HB330012	12
HB330014	14

■ **HB34**
Threaded bulkhead connector



	Ø	connection
HB340418	4	G1/8
HB340618	6	G1/8
HB340818	8	G1/8
HB340614	6	G1/4
HB340814	8	G1/4

■ **HB35**
Elbow bulkhead connector



	Ø
HB350004	4
HB350006	6
HB350008	8
HB350010	10

■ **HB38**
Stem elbow



	Ø1	Ø2
HB380400	4	4
HB380406	4	6
HB380600	6	6
HB380608	6	8
HB380800	8	8
HB381000	10	10
HB381200	12	12

■ **HB39**
Extended stem elbow



	Ø1	Ø2
HB390400	4	4
HB390406	4	6
HB390600	6	6
HB390608	6	8
HB390800	8	8

HB40

Single banjo (without bolt)



	Ø	bolt
HB4004M5	4	M5
HB4005M5	5	M5
HB4006M5	6	M5
HB400418	4	G1/8
HB400518	5	G1/8
HB400618	6	G1/8
HB400818	8	G1/8
HB400614	6	G1/4
HB400814	8	G1/4
HB401014	10	G1/4
HB401214	12	G1/4
HB400838	8	G3/8
HB401038	10	G3/8
HB401238	12	G3/8

HB41

Double banjo (without bolt)



	Ø	bolt
HB4104M5	4	M5
HB4105M5	5	M5
HB410418	4	G1/8
HB410518	5	G1/8
HB410618	6	G1/8
HB410818	8	G1/8
HB410614	6	G1/4
HB410814	8	G1/4
HB411014	10	G1/4
HB410838	8	G3/8
HB411038	10	G3/8
HB411238	12	G3/8

HB42

Single banjo bolt



	connection
HB4200M5	M5
HB420018	G1/8
HB420014	G1/4
HB420038	G3/8

HB43

Double banjo bolt



	connection
HB430018	G1/8
HB430014	G1/4
HB430038	G3/8

HB44

Triple banjo bolt



	connection
HB440018	G1/8
HB440014	G1/4
HB440038	G3/8

HB45

Swivel banjo central Tee (parallel male) with allen head



	Ø	connection
HB4504M5	4	M5
HB4505M5	5	M5
HB450418	4	G1/8
HB450518	5	G1/8
HB450618	6	G1/8
HB450818	8	G1/8
HB450614	6	G1/4
HB450814	8	G1/4
HB451014	10	G1/4
HB450838	8	G3/8
HB451038	10	G3/8
HB451238	12	G3/8

HB47

Double swivel banjo connector (male thread) with allen head



	Ø	connection
HB470418	4	G1/8
HB470618	6	G1/8
HB470818	8	G1/8
HB470614	6	G1/4
HB470814	8	G1/4
HB471014	10	G1/4
HB471214	12	G1/4

HB48

Triple swivel banjo connector (parallel thread) with allen head



	Ø	connection
HB480418	4	G1/8
HB480618	6	G1/8
HB480818	8	G1/8
HB480614	6	G1/4
HB480814	8	G1/4
HB481014	10	G1/4
HB481214	12	G1/4

HB49

Double stem



	Ø
HB490400	4
HB490500	5
HB490600	6
HB490800	8
HB491000	10
HB491200	12
HB491400	14

HB51

Adaptor parallel male



	Ø	connection		Ø	connection
HB5104M5	4	M5	HB510614	6	G1/4
HB5105M5	5	M5	HB510814	8	G1/4
HB5106M5	6	M5	HB511014	10	G1/4
HB510418	4	G1/8	HB511214	12	G1/4
HB510518	5	G1/8	HB510838	8	G3/8
HB510618	6	G1/8	HB511038	10	G3/8
HB510818	8	G1/8	HB511238	12	G3/8
HB511018	10	G1/8	HB511438	14	G3/8
HB510414	4	G1/4	HB511212	12	G1/2
HB510514	5	G1/4	HB511412	14	G1/2

HB53

Fixed elbow taper male



	Ø	connection
HB530418	4	R1/8
HB530518	5	R1/8
HB530618	6	R1/8
HB530818	8	R1/8
HB530614	6	R1/4
HB530814	8	R1/4
HB531014	10	R1/4

CHARACTERISTICS

Temperature	-20 ÷ 80 °C
Fluid	compressed air
Max pressure	15 bar (based on the type of tube)
Working pressure	9 bar
Body	technopolymer
Fixing elements	nickel-plated brass with O-ring in NBR for parallel thread version (standard) Teflon coating for taper thread version (upon request)
Clamp	stainless steel
Release ring	technopolymer
Application fields	pneumatic circuits
Recommended hoses	polyamide PA 10.12, polyurethane Sh.A98, co-polyurethane Sh.55D

Flow regulators in technopolymer

■ **HC01/HC02**

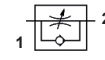
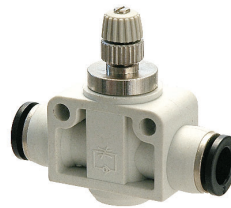
One-way banjo flow regulator



exhaust	supply	∅	connection
HC0104M5	HC0204M5	4	M5
HC0106M5	HC0206M5	6	M5
HC010418	HC020418	4	G1/8
HC010618	HC020618	6	G1/8
HC010818	HC020818	8	G1/8
HC010414	HC020414	4	G1/4
HC010614	HC020614	6	G1/4
HC010814	HC020814	8	G1/4
HC011014	HC021014	10	G1/4
HC010838	HC020838	8	G3/8
HC011038	HC021038	10	G3/8
HC011238	HC021238	12	G3/8
HC011012	HC021012	10	G1/2
HC011212	HC021212	12	G1/2

■ **HC04**

One-way in-line intermediate flow regulator



	∅1
HC040404	4
HC040606	6
HC040808	8
HC041010	10
HC041212	12

■ **HC01T/HC02T**

One-way swivel banjo flow regulator - screwdriver slot



exhaust	supply	∅	connection
HC01T0418	HC02T0418	4	G1/8
HC01T0618	HC02T0618	6	G1/8
HC01T0818	HC02T0818	8	G1/8
HC01T1018	HC02T1018	10	G1/8
HC01T1218	HC02T1218	12	G1/8
HC01T0614	HC02T0614	6	G1/4
HC01T0814	HC02T0814	8	G1/4
HC01T1014	HC02T1014	10	G1/4
HC01T1214	HC02T1214	12	G1/4
HC01T0638	HC02T0638	6	G3/8
HC01T0838	HC02T0838	8	G3/8
HC01T1038	HC02T1038	10	G3/8
HC01T1238	HC02T1238	12	G3/8

CHARACTERISTICS

Temperature	0 ÷ 70 °C
Fluid	compressed air
Max pressure	10 bar
Working pressure	0,3 ÷ 10 bar

Flow regulators with metallic body

■ **HC21/HC22**

One-way banjo flow regulator



	exhaust	supply	Ø	connection
exhaust 	HC2104M5	HC2204M5	4	M5
	HC210418	HC220418	4	G1/8
	HC210618	HC220618	6	G1/8
	HC210818	HC220818	8	G1/8
	HC210614	HC220614	6	G1/4
	HC210814	HC220814	8	G1/4
supply 	HC211014	HC221014	10	G1/4

■ **HC18/HC19**

One-way banjo flow regulator - screwdriver slot



	exhaust	supply	Ø	connection
exhaust 	HC1804M5	HC1904M5	4	M5
	HC180418	HC190418	4	G1/8
	HC180618	HC190618	6	G1/8
	HC180818	HC190818	8	G1/8
	HC180614	HC190614	6	G1/4
	HC180814	HC190814	8	G1/4
supply 	HC181014	HC191014	10	G1/4

■ **HC27/HC28**

One-way threaded flow regulator male/female



	exhaust	supply	connection
exhaust 	HC27M5M5	HC28M5M5	M5
	HC271818	HC281818	G1/8
	HC271414	HC281414	G1/4
	HC273838	HC283838	G3/8
	HC271212	HC281212	G1/2
supply 			

Non-return valve

■ **HC13**

Non-return valve F-F



	connection
HC1300M5	M5
HC130018	G1/8
HC130014	G1/4
HC130038	G3/8
HC130012	G1/2

High temperature seals upon request

■ **HC14**

Non-return valve F-M



	connection
HC140018	G1/8
HC140014	G1/4

High temperature seals upon request

■ **HC15**

Non-return valve with push-in tube connections



	Ø
HC150004	4
HC150006	6
HC150008	8

■ **HC17**

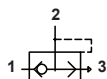
Non-return valve threaded connection



	Ø	connection
HC170418	4	G1/8
HC170618	6	G1/8
HC170818	8	G1/8
HC170614	6	G1/4
HC170814	8	G1/4
HC171038	10	G3/8
HC171238	12	G3/8
HC171012	10	G1/2
HC171212	12	G1/2

Quick exhaust valves

HC06
Quick exhaust valve



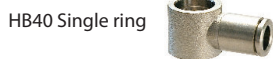
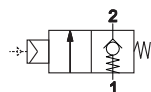
	connection	flow rate at 6 bar (NI/min)	
		1→2	2→3
HC0600M5	M5	220	300
HC060018	G1/8	680	1100
HC060014	G1/4	1200	2100
HC060038	G3/8	2300	4800
HC060012	G1/2	3400	6100
HC060034	G3/4	3200	8750
HC060001	G1	2900	10.750

Blocking valve

HC34



	M	F	flow rate at 6 bar (NI/min)
HC3418M5	G1/8	M5	400
HC3414M5	G1/4	M5	850
HC343818	G3/8	G1/8	1250

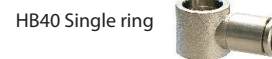
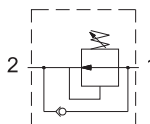


Miniature pressure regulator 0 ÷ 8 bar

HC35



	connection	flow rate at 6 bar (NI/min)
HC350018	G1/8	580
HC350014	G1/4	750

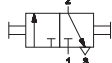


CHARACTERISTICS

Temperature	-25 ÷ 90 °C
Fluid	0 ÷ 60 °C (technopolymer HC11-12) compressed air, vacuum
Max pressure	15 bar
Working pressure	0 ÷ 10 bar

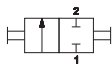
Line manual valve

HC05
Slide valve



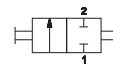
	connection
HC0500M5	M5
HC050018	G1/8
HC050014	G1/4
HC050038	G3/8
HC050012	G1/2
HC050034	G3/4

HC07
Ball valve F-F



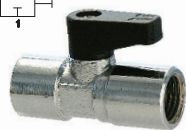
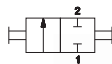
	connection
HC070018	G1/8
HC070014	G1/4
HC070038	G3/8
HC070012	G1/2
HC070034	G3/4

HC08
Ball valve M-F



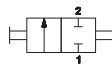
	connection
HC080018	G1/8
HC080014	G1/4
HC080038	G3/8
HC080012	G1/2
HC080034	G3/4

HC09
Miniature ball valve F-F with black handle



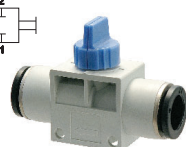
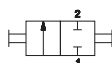
	connection
HC090018	G1/8
HC090014	G1/4

HC10
Miniature ball valve M-F with black handle



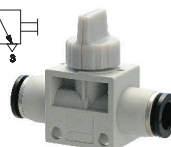
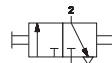
	connection
HC100018	G1/8
HC100014	G1/4

HC11
Manual 2/2 minivalve



	Ø
HC110606	6
HC110808	8
HC111010	10
HC111212	12

HC12
Manual 3/2 minivalve



	Ø
HC120606	6
HC120808	8
HC121010	10
HC121212	12

Silencers

HC51
Sintered bronze flat silencer



	connection
HC5100M5	M5
HC510018	G1/8
HC510014	G1/4
HC510038	G3/8
HC510012	G1/2
HC510034	G3/4
HC510001	G1
HC510112	G1 1/2

HC52
Sintered bronze cone silencer



	connection
HC5200M5	M5
HC520018	G1/8
HC520014	G1/4
HC520038	G3/8
HC520012	G1/2
HC520034	G3/4
HC520001	G1

HC53
Sintered bronze cone silencer
(with square wrench head)



	connection
HC5300M5	M5
HC530018	G1/8
HC530014	G1/4
HC530038	G3/8
HC530012	G1/2
HC530034	G3/4
HC530001	G1

HC54
Silencer with exhaust flow regulator (narrow)



	connection
HC5400M5	M5
HC540018	G1/8
HC540014	G1/4
HC540038	G3/8
HC540012	G1/2
HC540034	G3/4
HC540001	G1

HC55
Silencer with exhaust flow regulator



	connection
HC5500M5	M5
HC550018	G1/8
HC550014	G1/4
HC550038	G3/8
HC550012	G1/2
HC550034	G3/4
HC550001	G1

HC56
Technopolymer dynamic silencer



	connection
HC560018	G1/8
HC560014	G1/4
HC560038	G3/8
HC560012	G1/2
HC560034	G3/4
HC560001	G1

HC57
Polyethylene plastic silencer



	connection
HC5700M5	M5
HC570018	G1/8
HC570014	G1/4
HC570038	G3/8
HC570012	G1/2
HC570034	G3/4
HC570001	G1

HC58
Technopolymer silencer



	connection
HC580018	G1/8
HC580014	G1/4
HC580038	G3/8
HC580012	G1/2
HC580034	G3/4
HC580001	G1

HC59
Silencer with dome-shaped steel head



	connection
HC5900M5	M5
HC590018	G1/8
HC590014	G1/4
HC590038	G3/8
HC590012	G1/2
HC590034	G3/4
HC590001	G1

HC60
Cone silencer with hexagon nipple



	connection
HC6000M5	M5
HC600018	G1/8
HC600014	G1/4
HC600038	G3/8
HC600012	G1/2
HC600034	G3/4
HC600001	G1
HC600112	G1 1/2

HC61
Recessed silencer



	connection
HC6100M5	M5
HC610018	G1/8
HC610014	G1/4
HC610038	G3/8
HC610012	G1/2
HC610034	G3/4
HC610001	G1

CHARACTERISTICS

Temperature	-15 ÷ +80 °C
Max pressure	50 bar
Body	nickel-plated brass, aluminium, zinc-plated steel
Application fields	pneumatic circuits, low-pressure oleodynamic and hydraulic circuits, vacuum

HD01
 Parallel nipple


	connection 1	connection 2	key
HD01M5M5	M5	M5	8
HD01M518	M5	G1/8	14
HD011818	G1/8	G1/8	14
HD011814	G1/8	G1/4	17
HD011838	G1/8	G3/8	19
HD011414	G1/4	G1/4	17
HD011438	G1/4	G3/8	19
HD011412	G1/4	G1/2	24
HD013838	G3/8	G3/8	19
HD013812	G3/8	G1/2	24
HD011212	G1/2	G1/2	24
HD011234	G1/2	G3/4	30
HD013434	G3/4	G3/4	30

HD02
 Taper nipple


	connection 1	connection 2	key
HD021818	R1/8	R1/8	12
HD021814	R1/8	R1/4	14
HD021838	R1/8	R3/8	17
HD021414	R1/4	R1/4	14
HD021438	R1/4	R3/8	17
HD021412	R1/4	R1/2	22
HD023838	R3/8	R3/8	17
HD023812	R3/8	R1/2	22
HD021212	R1/2	R1/2	22
HD021234	R1/2	R3/4	27
HD023434	R3/4	R3/4	27
HD023401	R3/4	R1	34
HD020101	R1	R1	34

HD03
 Female socket


	connection	key
HD0300M5	M5	8
HD030018	G1/8	14
HD030014	G1/4	17
HD030038	G3/8	22
HD030012	G1/2	26
HD030034	G3/4	32

HD04
 Reduction M-F taper thread


	connection M	connection F	key
HD041814	R1/4	G1/8	14
HD041838	R3/8	G1/8	17
HD041812	R1/2	G1/8	22
HD041438	R3/8	G1/4	17
HD041412	R1/2	G1/4	22
HD043812	R1/2	G3/8	22
HD043834	R3/4	G3/8	27
HD041234	R3/4	G1/2	27

HD05
 Reduction M-F parallel thread


	connection M	connection F	key
HD05M518	G1/8	M5	14
HD051814	G1/4	G1/8	17
HD051838	G3/8	G1/8	19
HD051812	G1/2	G1/8	24
HD051438	G3/8	G1/4	19
HD051412	G1/2	G1/4	24
HD053812	G1/2	G3/8	24
HD053834	G3/4	G3/8	30
HD051234	G3/4	G1/2	30

HD06
 Extension M-F taper thread


	connection M	connection F	key
HD061818	R1/8	G1/8	14
HD061814	R1/8	G1/4	17
HD061838	R1/8	G3/8	22
HD061414	R1/4	G1/4	17
HD061438	R1/4	G3/8	22
HD061412	R1/4	G1/2	24
HD063838	R3/8	G3/8	22
HD063812	R3/8	G1/2	24
HD061212	R1/2	G1/2	26
HD061234	R1/2	G3/4	32

HD07
 Extension M-F parallel thread


	connection M	connection F	key
HD07M518	M5	G1/8	14
HD071818	G1/8	G1/8	14
HD071814	G1/8	G1/4	17
HD071838	G1/8	G3/8	22
HD071414	G1/4	G1/4	17
HD071438	G1/4	G3/8	22
HD071412	G1/4	G1/2	24
HD073838	G3/8	G3/8	22
HD073812	G3/8	G1/2	24
HD071212	G1/2	G1/2	26

HD08
 Extension M-F parallel thread


	connection M-F	key
HD081822	G1/8	14
HD081435	G1/4	17
HD081451	G1/4	17
HD081842	G1/8	14

HD09
 Extension F-F


	connection 1	connection 2	key
HD091814	G1/8	G1/4	17
HD091838	G1/8	G3/8	22
HD091812	G1/8	G1/2	24
HD091438	G1/4	G3/8	22
HD091412	G1/4	G1/2	24
HD093812	G3/8	G1/2	24
HD091234	G1/2	G3/4	32

HD10
 Male plug with hexagon wrench head


	connection	key
HD1000M5	M5	8
HD100018	G1/8	14
HD100014	G1/4	17
HD100038	G3/8	19
HD100012	G1/2	24
HD100034	G3/4	30
HD100001	G1	38

HD11
 Male plug (taper thread) with allen head


	connection	key
HD110018	R1/8	5
HD110014	R1/4	6
HD110038	R3/8	8
HD110012	R1/2	10

HD12
 Male plug with O-ring (allen head)


	connection	key
HD1200M5	M5	2,5
HD120018	G1/8	5
HD120014	G1/4	6
HD120038	G3/8	8
HD120012	G1/2	10

HD13
 Female plug


	connection	key
HD130018	G1/8	14
HD130014	G1/4	17
HD130038	G3/8	20
HD130012	G1/2	24

HD14
 Elbow connector F-F


	connection	key
HD1400M5	M5	8
HD140018	G1/8	10
HD140014	G1/4	13
HD140038	G3/8	17
HD140012	G1/2	21
HD140034	G3/4	25
HD140001	G1	30

HD15
 Elbow connector M-F


	connection M	connection F	key
HD1500M5	M5	M5	9
HD150018	R1/8	G1/8	10
HD151814	R1/4	G1/8	10
HD150014	R1/4	G1/4	13
HD150038	R3/8	G3/8	17
HD150012	R1/2	G1/2	21
HD150034	R3/4	G3/4	25
HD150001	R1	G1	30

HD16

Elbow connector M-M (taper thread)



	connection key		key
	1	2	
HD1600M5	M5	M5	9
HD160018	R1/8	R1/8	10
HD161814	R1/8	R1/4	10
HD160014	R1/4	R1/4	13
HD160038	R3/8	R3/8	17
HD160012	R1/2	R1/2	21
HD160034	R3/4	R3/4	25
HD160001	R1	R1	30

HD17

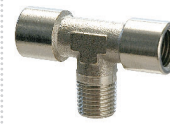
Intermediate Tee F-F-F (parallel thread)



	connection key		key
	M5		
HD1700M5	M5		9
HD170018	G1/8		10
HD170014	G1/4		13
HD170038	G3/8		17
HD170012	G1/2		21
HD170034	G3/4		25
HD170001	G1		30

HD18

Central Tee M-F-F



	connection key		key
	M	F	
HD1800M5	M5	M5	9
HD180018	R1/8	G1/8	10
HD180014	R1/4	G1/4	13
HD180038	R3/8	G3/8	17
HD180012	R1/2	G1/2	21
HD180034	R3/4	G3/4	25
HD180001	R1	G1	30

HD19

Lateral Tee M-F-F



	connection key		key
	M	F	
HD1900M5	M5	M5	9
HD190018	R1/8	G1/8	10
HD190014	R1/4	G1/4	13
HD190038	R3/8	G3/8	17
HD190012	R1/2	G1/2	21
HD190034	R3/4	G3/4	25
HD190001	R1	G1	30

HD20

Intermediate Tee M-M-M (taper thread)



	connection key		key
	R1/8		
HD200018	R1/8		10
HD200014	R1/4		13
HD200038	R3/8		17
HD200012	R1/2		21
HD200034	R3/4		25
HD200001	R1		30

HD21

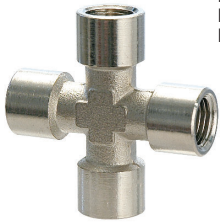
Lateral Tee M-F-M



	connection key		key
	M	F	
HD210018	R1/8	G1/8	10
HD210014	R1/4	G1/4	13
HD210038	R3/8	G3/8	17
HD210012	R1/2	G1/2	21
HD210034	R3/4	G3/4	25
HD210001	R1	G1	30

HD22

Cross F-F-F-F



	connection key		key
	G1/8		
HD220018	G1/8		10
HD220014	G1/4		13
HD220038	G3/8		17
HD220012	G1/2		21

HD24

Tube adaptor (parallel thread)



	Ø	connection key		key
		M5		
HD2404M5	4	M5		8
HD240618	6	G1/8		14
HD240718	7	G1/8		14
HD240818	8	G1/8		14
HD240918	9	G1/8		14
HD241018	10	G1/8		14
HD240614	6	G1/4		17
HD240714	7	G1/4		17
HD240814	8	G1/4		17
HD240914	9	G1/4		17
HD241014	10	G1/4		17
HD241214	12	G1/4		17
HD240938	9	G3/8		19
HD241038	10	G3/8		19

	Ø	connection key		key
		G3/8		
HD241238	12	G3/8		19
HD241438	14	G3/8		19
HD241738	17	G3/8		19
HD241212	12	G1/2		24
HD241412	14	G1/2		24
HD241712	17	G1/2		24
HD242012	20	G1/2		30
HD242034	20	G3/4		30

HD25

Y connector F-F-F



	connection key		key
	G1/8		
HD250018	G1/8		10
HD250014	G1/4		13
HD250038	G3/8		17
HD250012	G1/2		21

HD26

Y connector M-F-F



	connection key		key
	M	F	
HD260018	R1/8	G1/8	13
HD260014	R1/4	G1/4	17
HD260038	R3/8	G3/8	20
HD260012	R1/2	G1/2	25

HD27

Threaded bulkhead connector



	connection key		key
	M5		
HD2700M5	M5		14
HD270018	G1/8		19
HD270014	G1/4		24
HD270038	G3/8		30
HD270012	G1/2		32

HD32

Female single banjo



	connection key		key
	M5		
HD3200M5	M5		
HD320018	G1/8		
HD320014	G1/4		

HD33

Taper nipple - 3 pieces



	connection key		key
	R1/8		
HD330018	R1/8		15
HD330014	R1/4		19
HD330038	R3/8		22
HD330012	R1/2		27
HD330034	R3/4		36
HD330001	R1		46

HD34

Nipple M-F 3 pieces



	connection key		key
	M	F	
HD340018	R1/8	G1/8	14
HD340014	R1/4	G1/4	17
HD340038	R3/8	G3/8	21
HD340012	R1/2	G1/2	25

HD42

Single banjo bolt



Washer to be used
HD46 2 pcs

	connection key		key
	M5		
HD4200M5	M5		8
HD420018	R1/8		14
HD420014	R1/4		17
HD420038	R3/8		19
HD420012	R1/2		24

HD43

Double banjo bolt



Washer to be used
HD46 3 pcs

	connection key		key
	R1/8		
HD430018	R1/8		14
HD430014	R1/4		17
HD430038	R3/8		19
HD430012	R1/2		24

HD44

Triple banjo bolt



Washer to be used
HD46 4 pcs

	connection key		key
	R1/8		
HD440018	R1/8		14
HD440014	R1/4		17

■ **HD45**
Aluminium washer



	connection	thickness (mm)
HD4500M5	M5	1
HD450018	G1/8	1,5
HD450014	G1/4	1,5
HD450038	G3/8	1,5
HD450012	G1/2	1,5

■ **HD46**
Indented nylon washer



	connection	thickness (mm)
HD4600M5	M5	1
HD460018	G1/8	1,6
HD460014	G1/4	1,6
HD460038	G3/8	1,8
HD460012	G1/2	2

Accessories

■ **HD23**
Cross block F-F-F-F



	connection
HD230018	G1/8
HD230014	G1/4
HD230038	G3/8
HD230012	G1/2

■ **HD30**
Distribution manifold (single outlets)



	In	Out	nr.
HD301803	G1/4	G1/8	3
HD301804	G1/4	G1/8	4
HD301805	G1/4	G1/8	5
HD301806	G1/4	G1/8	6
HD301403	G3/8	G1/4	3
HD301404	G3/8	G1/4	4
HD301405	G3/8	G1/4	5
HD301406	G3/8	G1/4	6
HD303803	G1/2	G3/8	3
HD303804	G1/2	G3/8	4
HD303805	G1/2	G3/8	5
HD303806	G1/2	G3/8	6

■ **HD31**
Distributors manifold (double outlets)



	In	Out	nr.
HD311803	G1/4	G1/8	3+3
HD311804	G1/4	G1/8	4+4
HD311805	G1/4	G1/8	5+5
HD311403	G3/8	G1/4	3+3
HD311404	G3/8	G1/4	4+4
HD311405	G3/8	G1/4	5+5

■ **HD40**
Reservoir (Max pressure 10 bar)



HD400100	lt 1
HD400250	lt 2,5
HD400500	lt 5
HD400700	lt 7
HD401200	lt 12

■ **HD410000A**
Stainless steel AISI 301 bracket



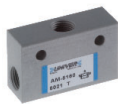
■ **HD410000B**
Reservoir extension



■ **AM50**



■ **AM51**



■ **AM52**



■ **AM53**



■ **AM54**



■ **AM5200**



■ **AM5220**



■ **AM55**



See VALVES chapter

CHARACTERISTICS

Temperature	-15 ÷ 80 °C
Fluid	compressed air, vacuum, liquid
Max pressure	16 bar
Working pressure	-0,99 ÷ 10 bar
Body	nickel-plated brass
Nut	nickel-plated brass
Seal	NBR
Application fields	pneumatic circuits
Recommended tube	polyamide PA 10.12, polyurethane Sh.A98, co-polyurethane Sh.55D

5
HGC03
 Male straight taper thread


Ø connection		Ø connection	
HGC030418	4 - 2,7 R1/8	HGC030838	8 - 6 R3/8
HGC030518	5 - 3 R1/8	HGC031038	10 - 8 R3/8
HGC030618	6 - 4 R1/8	HGC031238	12 - 10 R3/8
HGC030818	8 - 6 R1/8	HGC030812	8 - 6 R1/2
HGC031018	10 - 8 R1/8	HGC031012	10 - 8 R1/2
HGC030614	6 - 4 R1/4	HGC031212	12 - 10 R1/2
HGC030814	8 - 6 R1/4	HGC031512	15 - 12,5 R1/2
HGC031014	10 - 8 R1/4		
HGC030638	6 - 4 R3/8		

HGC04
 Male straight parallel thread with O-Ring


Ø connection		Ø connection	
HGC0404M5	4 - 2,7 M5	HGC041038	10 - 8 G3/8
HGC0405M5	5 - 3 M5	HGC041238	12 - 10 G3/8
HGC0406M5	6 - 4 M5	HGC041012	10 - 8 G1/2
HGC040418	4 - 2,7 G1/8	HGC041212	12 - 10 G1/2
HGC040618	6 - 4 G1/8		
HGC040818	8 - 6 G1/8		
HGC041018	10 - 8 G1/8		
HGC040614	6 - 4 G1/4		
HGC040814	8 - 6 G1/4		
HGC041014	10 - 8 G1/4		
HGC040838	8 - 6 G3/8		

HGC07
 Female straight


Ø connection	
HGC070618	6 - 4 G1/8
HGC070818	8 - 6 G1/8
HGC070614	6 - 4 G1/4
HGC070814	8 - 6 G1/4
HGC071014	10 - 8 G1/4
HGC070838	8 - 6 G3/8
HGC071038	10 - 8 G3/8
HGC071238	12 - 10 G3/8

HGC08
 Female elbow


Ø connection	
HGC080618	6 - 4 G1/8
HGC080614	6 - 4 G1/4
HGC080818	8 - 6 G1/8
HGC080814	8 - 6 G1/4
HGC080838	8 - 6 G3/8
HGC081014	10 - 8 G1/4
HGC081038	10 - 8 G3/8
HGC081238	12 - 10 G3/8

HGC09
 Taper elbow connection male


Ø connection	
HGC090418	4 - 2,7 R1/8
HGC090518	5 - 3 R1/8
HGC090618	6 - 4 R1/8
HGC090818	8 - 6 R1/8
HGC091018	10 - 8 R1/8
HGC090614	6 - 4 R1/4
HGC090814	8 - 6 R1/4
HGC091014	10 - 8 R1/4
HGC090638	6 - 4 R3/8
HGC090838	8 - 6 R3/8
HGC091038	10 - 8 R3/8
HGC091238	12 - 10 R3/8
HGC090812	8 - 6 R1/2
HGC091012	10 - 8 R1/2
HGC091212	12 - 10 R1/2
HGC091512	15 - 12,5 R1/2

HGC10
 Swivel elbow with OR


Ø connection	
HGC100618	6 - 4 G1/8
HGC100818	8 - 6 G1/8
HGC100614	6 - 4 G1/4
HGC100814	8 - 6 G1/4
HGC101014	10 - 8 G1/4
HGC100838	8 - 6 G3/8
HGC101038	10 - 8 G3/8
HGC101238	12 - 10 G3/8

HGC14
 Male lateral Tee taper thread


Ø connection	
HGC140618	6 - 4 R1/8
HGC140614	6 - 4 R1/4
HGC140818	8 - 6 R1/8
HGC140814	8 - 6 R1/4
HGC140838	8 - 6 R3/8
HGC141014	10 - 8 R1/4
HGC141038	10 - 8 R3/8
HGC141012	10 - 8 R1/2
HGC141238	12 - 10 R3/8
HGC141212	12 - 10 R1/2
HGC141512	15 - 12,5 R1/2

HGC16
 Male central Tee taper thread


Ø connection	
HGC160618	6 - 4 R1/8
HGC160614	6 - 4 R1/4
HGC160818	8 - 6 R1/8
HGC160814	8 - 6 R1/4
HGC160838	8 - 6 R3/8
HGC161014	10 - 8 R1/4
HGC161038	10 - 8 R3/8
HGC161012	10 - 8 R1/2
HGC161238	12 - 10 R3/8
HGC161212	12 - 10 R1/2
HGC161512	15 - 12,5 R1/2

HGC19
 Intermediate straight


Ø	
HGC190600	6 - 4
HGC190800	8 - 6
HGC191000	10 - 8
HGC191200	12 - 10
HGC191500	15 - 12,5

HGC20
 Intermediate elbow


Ø	
HGC200400	4 - 2,7
HGC200600	6 - 4
HGC200800	8 - 6
HGC201000	10 - 8
HGC201200	12 - 10
HGC201500	15 - 12,5

HGC21
 Intermediate Tee


Ø	
HGC210400	4 - 2,7
HGC210600	6 - 4
HGC210800	8 - 6
HGC211000	10 - 8
HGC211200	12 - 10
HGC211500	15 - 12,5

■ **HGC22**
Intermediate cross



	Ø
HGC220600	6 - 4
HGC220800	8 - 6
HGC221000	10 - 8

■ **HGC30**
Nut



	Ø	thread
HGC300400	4 - 2	M7x0,75
HGC300600	6 - 4	M10x1
HGC300800	8 - 6	M12x1
HGC301000	10 - 8	M14x1
HGC301200	12 - 10	M16x1
HGC301500	15 - 12,5	M20x1

■ **HGC33**
Intermediate straight bulkhead connector



	Ø
HGC330610	6 - 4
HGC330812	8 - 6
HGC331014	10 - 8
HGC331216	12 - 10
HGC331520	15 - 12,5

■ **HGC40**
Single banjo




	Ø	connection
HGC4004M5	4 - 2	M5
HGC4005M5	5 - 3	M5
HGC4006M5	6 - 4	M5
HGC400618	6 - 4	G1/8
HGC400818	8 - 6	G1/8
HGC400614	6 - 4	G1/4
HGC400814	8 - 6	G1/4
HGC401014	10 - 8	G1/4
HGC400838	8 - 6	G3/8
HGC401038	10 - 8	G3/8

Bolt to be used:
HD42 - HD43 - HD44

CHARACTERISTICS

Temperature	-15 ÷ 80 °C
Fluid	compressed air, water, oil
Working pressure	130 bar (Ø4), 180 bar (Ø6), 150 bar (Ø8), 110 bar (Ø10), 75 bar (Ø12), 70 bar (Ø15)
Body	nickel-plated brass
Nut	nickel-plated brass
Seals	NBR
Application fields	pneumatic circuits
Recommended tube	copper alloy, brass, stainless steel, aluminum, plastic (reinforcing core)

5

<p>■ HGO03 Male straight taper thread</p>  <table border="0"> <thead> <tr> <th></th> <th>Ø</th> <th>connection</th> </tr> </thead> <tbody> <tr><td>HGO030418</td><td>4</td><td>R1/8</td></tr> <tr><td>HGO030618</td><td>6</td><td>R1/8</td></tr> <tr><td>HGO030818</td><td>8</td><td>R1/8</td></tr> <tr><td>HGO030614</td><td>6</td><td>R1/4</td></tr> <tr><td>HGO030814</td><td>8</td><td>R1/4</td></tr> <tr><td>HGO031014</td><td>10</td><td>R1/4</td></tr> <tr><td>HGO030838</td><td>8</td><td>R3/8</td></tr> <tr><td>HGO031038</td><td>10</td><td>R3/8</td></tr> <tr><td>HGO031238</td><td>12</td><td>R3/8</td></tr> <tr><td>HGO031212</td><td>12</td><td>R1/2</td></tr> <tr><td>HGO031512</td><td>15</td><td>R1/2</td></tr> </tbody> </table>		Ø	connection	HGO030418	4	R1/8	HGO030618	6	R1/8	HGO030818	8	R1/8	HGO030614	6	R1/4	HGO030814	8	R1/4	HGO031014	10	R1/4	HGO030838	8	R3/8	HGO031038	10	R3/8	HGO031238	12	R3/8	HGO031212	12	R1/2	HGO031512	15	R1/2	<p>■ HGO04 Male straight parallel thread</p>  <table border="0"> <thead> <tr> <th></th> <th>Ø</th> <th>connection</th> </tr> </thead> <tbody> <tr><td>HGO040418</td><td>4</td><td>G1/8</td></tr> <tr><td>HGO040618</td><td>6</td><td>G1/8</td></tr> <tr><td>HGO040818</td><td>8</td><td>G1/8</td></tr> <tr><td>HGO040614</td><td>6</td><td>G1/4</td></tr> <tr><td>HGO040814</td><td>8</td><td>G1/4</td></tr> <tr><td>HGO041014</td><td>10</td><td>G1/4</td></tr> <tr><td>HGO040838</td><td>8</td><td>G3/8</td></tr> <tr><td>HGO041038</td><td>10</td><td>G3/8</td></tr> </tbody> </table>		Ø	connection	HGO040418	4	G1/8	HGO040618	6	G1/8	HGO040818	8	G1/8	HGO040614	6	G1/4	HGO040814	8	G1/4	HGO041014	10	G1/4	HGO040838	8	G3/8	HGO041038	10	G3/8	<p>■ HGO09 Male elbow taper thread</p>  <table border="0"> <thead> <tr> <th></th> <th>Ø</th> <th>connection</th> </tr> </thead> <tbody> <tr><td>HGO090418</td><td>4</td><td>R1/8</td></tr> <tr><td>HGO090618</td><td>6</td><td>R1/8</td></tr> <tr><td>HGO090818</td><td>8</td><td>R1/8</td></tr> <tr><td>HGO090614</td><td>6</td><td>R1/4</td></tr> <tr><td>HGO090814</td><td>8</td><td>R1/4</td></tr> <tr><td>HGO091014</td><td>10</td><td>R1/4</td></tr> <tr><td>HGO090838</td><td>8</td><td>R3/8</td></tr> <tr><td>HGO091038</td><td>10</td><td>R3/8</td></tr> <tr><td>HGO091238</td><td>12</td><td>R3/8</td></tr> <tr><td>HGO091212</td><td>12</td><td>R1/2</td></tr> <tr><td>HGO091512</td><td>15</td><td>R1/2</td></tr> </tbody> </table>		Ø	connection	HGO090418	4	R1/8	HGO090618	6	R1/8	HGO090818	8	R1/8	HGO090614	6	R1/4	HGO090814	8	R1/4	HGO091014	10	R1/4	HGO090838	8	R3/8	HGO091038	10	R3/8	HGO091238	12	R3/8	HGO091212	12	R1/2	HGO091512	15	R1/2
	Ø	connection																																																																																																			
HGO030418	4	R1/8																																																																																																			
HGO030618	6	R1/8																																																																																																			
HGO030818	8	R1/8																																																																																																			
HGO030614	6	R1/4																																																																																																			
HGO030814	8	R1/4																																																																																																			
HGO031014	10	R1/4																																																																																																			
HGO030838	8	R3/8																																																																																																			
HGO031038	10	R3/8																																																																																																			
HGO031238	12	R3/8																																																																																																			
HGO031212	12	R1/2																																																																																																			
HGO031512	15	R1/2																																																																																																			
	Ø	connection																																																																																																			
HGO040418	4	G1/8																																																																																																			
HGO040618	6	G1/8																																																																																																			
HGO040818	8	G1/8																																																																																																			
HGO040614	6	G1/4																																																																																																			
HGO040814	8	G1/4																																																																																																			
HGO041014	10	G1/4																																																																																																			
HGO040838	8	G3/8																																																																																																			
HGO041038	10	G3/8																																																																																																			
	Ø	connection																																																																																																			
HGO090418	4	R1/8																																																																																																			
HGO090618	6	R1/8																																																																																																			
HGO090818	8	R1/8																																																																																																			
HGO090614	6	R1/4																																																																																																			
HGO090814	8	R1/4																																																																																																			
HGO091014	10	R1/4																																																																																																			
HGO090838	8	R3/8																																																																																																			
HGO091038	10	R3/8																																																																																																			
HGO091238	12	R3/8																																																																																																			
HGO091212	12	R1/2																																																																																																			
HGO091512	15	R1/2																																																																																																			
<p>■ HGO14 Male lateral Tee</p>  <table border="0"> <thead> <tr> <th></th> <th>Ø</th> <th>connection</th> </tr> </thead> <tbody> <tr><td>HGO140418</td><td>4</td><td>R1/8</td></tr> <tr><td>HGO140618</td><td>6</td><td>R1/8</td></tr> <tr><td>HGO140818</td><td>8</td><td>R1/8</td></tr> <tr><td>HGO140614</td><td>6</td><td>R1/4</td></tr> <tr><td>HGO140814</td><td>8</td><td>R1/4</td></tr> <tr><td>HGO141014</td><td>10</td><td>R1/4</td></tr> <tr><td>HGO141038</td><td>10</td><td>R3/8</td></tr> <tr><td>HGO141238</td><td>12</td><td>R3/8</td></tr> <tr><td>HGO141212</td><td>12</td><td>R1/2</td></tr> </tbody> </table>		Ø	connection	HGO140418	4	R1/8	HGO140618	6	R1/8	HGO140818	8	R1/8	HGO140614	6	R1/4	HGO140814	8	R1/4	HGO141014	10	R1/4	HGO141038	10	R3/8	HGO141238	12	R3/8	HGO141212	12	R1/2	<p>■ HGO16 Male central Tee taper thread</p>  <table border="0"> <thead> <tr> <th></th> <th>Ø</th> <th>connection</th> </tr> </thead> <tbody> <tr><td>HGO160418</td><td>4</td><td>R1/8</td></tr> <tr><td>HGO160618</td><td>6</td><td>R1/8</td></tr> <tr><td>HGO160818</td><td>8</td><td>R1/8</td></tr> <tr><td>HGO160614</td><td>6</td><td>R1/4</td></tr> <tr><td>HGO160814</td><td>8</td><td>R1/4</td></tr> <tr><td>HGO161014</td><td>10</td><td>R1/4</td></tr> <tr><td>HGO161038</td><td>10</td><td>R3/8</td></tr> <tr><td>HGO161238</td><td>12</td><td>R3/8</td></tr> <tr><td>HGO161212</td><td>12</td><td>R1/2</td></tr> <tr><td>HGO161512</td><td>15</td><td>R1/2</td></tr> </tbody> </table>		Ø	connection	HGO160418	4	R1/8	HGO160618	6	R1/8	HGO160818	8	R1/8	HGO160614	6	R1/4	HGO160814	8	R1/4	HGO161014	10	R1/4	HGO161038	10	R3/8	HGO161238	12	R3/8	HGO161212	12	R1/2	HGO161512	15	R1/2	<p>■ HGO19 Intermediate straight</p>  <table border="0"> <thead> <tr> <th></th> <th>Ø</th> </tr> </thead> <tbody> <tr><td>HGO190400</td><td>4</td></tr> <tr><td>HGO190600</td><td>6</td></tr> <tr><td>HGO190800</td><td>8</td></tr> <tr><td>HGO191000</td><td>10</td></tr> <tr><td>HGO191200</td><td>12</td></tr> <tr><td>HGO191500</td><td>15</td></tr> </tbody> </table>		Ø	HGO190400	4	HGO190600	6	HGO190800	8	HGO191000	10	HGO191200	12	HGO191500	15																						
	Ø	connection																																																																																																			
HGO140418	4	R1/8																																																																																																			
HGO140618	6	R1/8																																																																																																			
HGO140818	8	R1/8																																																																																																			
HGO140614	6	R1/4																																																																																																			
HGO140814	8	R1/4																																																																																																			
HGO141014	10	R1/4																																																																																																			
HGO141038	10	R3/8																																																																																																			
HGO141238	12	R3/8																																																																																																			
HGO141212	12	R1/2																																																																																																			
	Ø	connection																																																																																																			
HGO160418	4	R1/8																																																																																																			
HGO160618	6	R1/8																																																																																																			
HGO160818	8	R1/8																																																																																																			
HGO160614	6	R1/4																																																																																																			
HGO160814	8	R1/4																																																																																																			
HGO161014	10	R1/4																																																																																																			
HGO161038	10	R3/8																																																																																																			
HGO161238	12	R3/8																																																																																																			
HGO161212	12	R1/2																																																																																																			
HGO161512	15	R1/2																																																																																																			
	Ø																																																																																																				
HGO190400	4																																																																																																				
HGO190600	6																																																																																																				
HGO190800	8																																																																																																				
HGO191000	10																																																																																																				
HGO191200	12																																																																																																				
HGO191500	15																																																																																																				
<p>■ HGO20 Intermediate elbow</p>  <table border="0"> <thead> <tr> <th></th> <th>Ø</th> </tr> </thead> <tbody> <tr><td>HGO200400</td><td>4</td></tr> <tr><td>HGO200600</td><td>6</td></tr> <tr><td>HGO200800</td><td>8</td></tr> <tr><td>HGO201000</td><td>10</td></tr> <tr><td>HGO201200</td><td>12</td></tr> </tbody> </table>		Ø	HGO200400	4	HGO200600	6	HGO200800	8	HGO201000	10	HGO201200	12	<p>■ HGO21 Intermediate Tee</p>  <table border="0"> <thead> <tr> <th></th> <th>Ø</th> </tr> </thead> <tbody> <tr><td>HGO210400</td><td>4</td></tr> <tr><td>HGO210600</td><td>6</td></tr> <tr><td>HGO210800</td><td>8</td></tr> <tr><td>HGO211000</td><td>10</td></tr> <tr><td>HGO211200</td><td>12</td></tr> <tr><td>HGO211500</td><td>15</td></tr> </tbody> </table>		Ø	HGO210400	4	HGO210600	6	HGO210800	8	HGO211000	10	HGO211200	12	HGO211500	15	<p>■ HGO30 Nut</p>  <table border="0"> <thead> <tr> <th></th> <th>Ø</th> <th>thread</th> <th>key</th> </tr> </thead> <tbody> <tr><td>HGO300400</td><td>4</td><td>8x1</td><td>10</td></tr> <tr><td>HGO300600</td><td>6</td><td>10x1</td><td>12</td></tr> <tr><td>HGO300800</td><td>8</td><td>12x1</td><td>14</td></tr> <tr><td>HGO301000</td><td>10</td><td>16x1</td><td>19</td></tr> <tr><td>HGO301200</td><td>12</td><td>18x1</td><td>22</td></tr> <tr><td>HGO301500</td><td>15</td><td>30x1</td><td>27</td></tr> </tbody> </table>		Ø	thread	key	HGO300400	4	8x1	10	HGO300600	6	10x1	12	HGO300800	8	12x1	14	HGO301000	10	16x1	19	HGO301200	12	18x1	22	HGO301500	15	30x1	27																																													
	Ø																																																																																																				
HGO200400	4																																																																																																				
HGO200600	6																																																																																																				
HGO200800	8																																																																																																				
HGO201000	10																																																																																																				
HGO201200	12																																																																																																				
	Ø																																																																																																				
HGO210400	4																																																																																																				
HGO210600	6																																																																																																				
HGO210800	8																																																																																																				
HGO211000	10																																																																																																				
HGO211200	12																																																																																																				
HGO211500	15																																																																																																				
	Ø	thread	key																																																																																																		
HGO300400	4	8x1	10																																																																																																		
HGO300600	6	10x1	12																																																																																																		
HGO300800	8	12x1	14																																																																																																		
HGO301000	10	16x1	19																																																																																																		
HGO301200	12	18x1	22																																																																																																		
HGO301500	15	30x1	27																																																																																																		
<p>■ HGO31 Olive</p>  <table border="0"> <thead> <tr> <th></th> <th>Ø</th> </tr> </thead> <tbody> <tr><td>HGO310400</td><td>4</td></tr> <tr><td>HGO310600</td><td>6</td></tr> <tr><td>HGO310800</td><td>8</td></tr> <tr><td>HGO311000</td><td>10</td></tr> <tr><td>HGO311200</td><td>12</td></tr> <tr><td>HGO311500</td><td>15</td></tr> </tbody> </table>		Ø	HGO310400	4	HGO310600	6	HGO310800	8	HGO311000	10	HGO311200	12	HGO311500	15	<p>■ HGO32 Reinforcing core</p>  <table border="0"> <thead> <tr> <th></th> <th>Ø</th> </tr> </thead> <tbody> <tr><td>HGO320600</td><td>4</td></tr> <tr><td>HGO320800</td><td>6</td></tr> <tr><td>HGO321000</td><td>8</td></tr> <tr><td>HGO321200</td><td>10</td></tr> <tr><td>HGO321500</td><td>12,5</td></tr> </tbody> </table>		Ø	HGO320600	4	HGO320800	6	HGO321000	8	HGO321200	10	HGO321500	12,5	<p>■ HGO33 Bulkhead connector</p>  <table border="0"> <thead> <tr> <th></th> <th>Ø</th> </tr> </thead> <tbody> <tr><td>HGO330600</td><td>6</td></tr> <tr><td>HGO330800</td><td>8</td></tr> <tr><td>HGO331000</td><td>10</td></tr> <tr><td>HGO331200</td><td>12</td></tr> </tbody> </table>		Ø	HGO330600	6	HGO330800	8	HGO331000	10	HGO331200	12	<p>■ HGO40 Single banjo</p>  <table border="0"> <thead> <tr> <th></th> <th>Ø</th> <th>connection</th> </tr> </thead> <tbody> <tr><td>HGO400618</td><td>6</td><td>G1/8</td></tr> <tr><td>HGO400818</td><td>8</td><td>G1/8</td></tr> <tr><td>HGO400614</td><td>6</td><td>G1/4</td></tr> <tr><td>HGO400814</td><td>8</td><td>G1/4</td></tr> </tbody> </table> <p>Bolt to be used: HD42 - HD43 - HD44</p>		Ø	connection	HGO400618	6	G1/8	HGO400818	8	G1/8	HGO400614	6	G1/4	HGO400814	8	G1/4																																															
	Ø																																																																																																				
HGO310400	4																																																																																																				
HGO310600	6																																																																																																				
HGO310800	8																																																																																																				
HGO311000	10																																																																																																				
HGO311200	12																																																																																																				
HGO311500	15																																																																																																				
	Ø																																																																																																				
HGO320600	4																																																																																																				
HGO320800	6																																																																																																				
HGO321000	8																																																																																																				
HGO321200	10																																																																																																				
HGO321500	12,5																																																																																																				
	Ø																																																																																																				
HGO330600	6																																																																																																				
HGO330800	8																																																																																																				
HGO331000	10																																																																																																				
HGO331200	12																																																																																																				
	Ø	connection																																																																																																			
HGO400618	6	G1/8																																																																																																			
HGO400818	8	G1/8																																																																																																			
HGO400614	6	G1/4																																																																																																			
HGO400814	8	G1/4																																																																																																			

CHARACTERISTICS

Temperature	-10 ÷ 80 °C
Fluid	compressed air
Working pressure	12 bar
Body	nickel-plated brass, zinc-plated steel
Ferrule	nickel-plated brass, zinc-plated steel
Seals	NBR
Spring	nickel-plated brass, zinc-plated steel

<p>■ HGU2001M Universal male socket</p>  <table border="0"> <tr> <td></td> <td style="text-align: right;">connection</td> </tr> <tr> <td>HGU2001M14</td> <td>G1/4</td> </tr> <tr> <td>HGU2001M38</td> <td>G3/8</td> </tr> <tr> <td>HGU2001M12</td> <td>G1/2</td> </tr> </table>		connection	HGU2001M14	G1/4	HGU2001M38	G3/8	HGU2001M12	G1/2	<p>■ HGU2001F Universal female socket</p>  <table border="0"> <tr> <td></td> <td style="text-align: right;">connection</td> </tr> <tr> <td>HGU2001F14</td> <td>G1/4</td> </tr> <tr> <td>HGU2001F38</td> <td>G3/8</td> </tr> <tr> <td>HGU2001F12</td> <td>G1/2</td> </tr> </table>		connection	HGU2001F14	G1/4	HGU2001F38	G3/8	HGU2001F12	G1/2	<p>■ HGU2002M Universal male plug</p>  <table border="0"> <tr> <td></td> <td style="text-align: right;">connection</td> </tr> <tr> <td>HGU2002M14</td> <td>G1/4</td> </tr> <tr> <td>HGU2002M38</td> <td>G3/8</td> </tr> </table>		connection	HGU2002M14	G1/4	HGU2002M38	G3/8
	connection																							
HGU2001M14	G1/4																							
HGU2001M38	G3/8																							
HGU2001M12	G1/2																							
	connection																							
HGU2001F14	G1/4																							
HGU2001F38	G3/8																							
HGU2001F12	G1/2																							
	connection																							
HGU2002M14	G1/4																							
HGU2002M38	G3/8																							
<p>■ HGU2002F Universal female plug</p>  <table border="0"> <tr> <td></td> <td style="text-align: right;">connection</td> </tr> <tr> <td>HGU2002F14</td> <td>G1/4</td> </tr> <tr> <td>HGU2002F38</td> <td>G3/8</td> </tr> </table>		connection	HGU2002F14	G1/4	HGU2002F38	G3/8	<p>■ HGU1001M Male mini socket</p>  <table border="0"> <tr> <td></td> <td style="text-align: right;">connection</td> </tr> <tr> <td>HGU1001M18</td> <td>G1/8</td> </tr> <tr> <td>HGU1001M14</td> <td>G1/4</td> </tr> </table>		connection	HGU1001M18	G1/8	HGU1001M14	G1/4	<p>■ HGU1001F Female mini socket</p>  <table border="0"> <tr> <td></td> <td style="text-align: right;">connection</td> </tr> <tr> <td>HGU1001F18</td> <td>G1/8</td> </tr> <tr> <td>HGU1001F14</td> <td>G1/4</td> </tr> </table>		connection	HGU1001F18	G1/8	HGU1001F14	G1/4				
	connection																							
HGU2002F14	G1/4																							
HGU2002F38	G3/8																							
	connection																							
HGU1001M18	G1/8																							
HGU1001M14	G1/4																							
	connection																							
HGU1001F18	G1/8																							
HGU1001F14	G1/4																							
<p>■ HGU1002M Male mini plug</p>  <table border="0"> <tr> <td></td> <td style="text-align: right;">connection</td> </tr> <tr> <td>HGU1002M18</td> <td>G1/8</td> </tr> <tr> <td>HGU1002M14</td> <td>G1/4</td> </tr> </table>		connection	HGU1002M18	G1/8	HGU1002M14	G1/4	<p>■ HGU1002F Female mini plug</p>  <table border="0"> <tr> <td></td> <td style="text-align: right;">connection</td> </tr> <tr> <td>HGU1002F18</td> <td>G1/8</td> </tr> <tr> <td>HGU1002F14</td> <td>G1/4</td> </tr> </table>		connection	HGU1002F18	G1/8	HGU1002F14	G1/4											
	connection																							
HGU1002M18	G1/8																							
HGU1002M14	G1/4																							
	connection																							
HGU1002F18	G1/8																							
HGU1002F14	G1/4																							

For further technical information contact our Sales Office

HE

HEA

 Polyamide tubes PA10.12
Colors: neutral, black, blue, sky-blue

Part No.	Tube		
	Ø E	Ø I	R
HEA0420...	4	2	15
HEA0425...	4	2,5	20
HEA0604...	6	4	35
HEA0806...	8	6	40
HEA1008...	10	8	60
HEA1210...	12	10	85
HEA1412...	14	12	95

HEC

 Polyurethane tubes Sh. A98
Colors: neutral, black, sky-blue

Part No.	Tube		
	Ø E	Ø I	R
HEC0420...	4	2	15
HEC0604...	6	4	20
HEC0806...	8	6	25
HEC1008...	10	8	35
HEC1209...	12	9	45

HED

 Co-polyurethane tubes Sh. 55D
Colors: neutral, black, blue, sky-blue

Part No.	Tube		
	Ø E	Ø I	R
HED0420...	4	2,5	10
HED0604...	6	4	15
HED0806...	8	6	25
HED1008...	10	8	35
HED1209...	12	9	45

Ø E = External diameter (mm) Ø I = Internal diameter (mm) R = Bending radius (mm)

For color options, add the following suffixes to part no.:

 NEU = Neutral **NER** = Black **BLU** = Blue **AZZ** = Sky-blue (example HEA0420NEU)

Min. package: 100 m coil
HF
HFA Rilsan® Spiral tubes

 Polyamide Spiral Tubes PA10.12
Colors: neutral, blue, sky-blue, orange

 HFA121015... and HFA121030...
available only blue and orange

Part No.	Tube			Spiral		
	Ø E	Ø I	Linear (mt)	Rest (mm)	Max Length (mt)	Ø I (mm)
HFA042010...	4	2	10	360	6	30
HFA042015...	4	2	15	550	9	30
HFA060415...	6	4	15	430	9	60
HFA060430...	6	4	30	870	17	60
HFA080615...	8	6	15	455	9	80
HFA080630...	8	6	30	910	17	80
HFA100815...	10	8	15	490	9	90
HFA100830...	10	8	30	990	17	90
HFA121015...	12	10	15	430	9	120
HFA121030...	12	10	30	870	17	120

HFC Elastollan® Spiral tubes with straight ends

 Polyurethane Spiral Tubes (Sh.A98) with ends paralleling the spiral axis
Colors: neutral, sky-blue

Part No.	Tube			Spiral		
	Ø E	Ø I	Linear (mt)	Rest (mm)	Max Length (mt)	Ø I (mm)
HFC64C06...	6	4	6	380	4	25
HFC64C12...	6	4	12	760	8	25
HFC85C06...	8	5,5	6	310	4	40
HFC85C12...	8	5,5	12	640	8	40
HFC107C06...	10	7	6	330	4	50
HFC107C12...	10	7	12	680	8	50
HFC128C06...	12	8	6	320	4	60
HFC128C12...	12	8	12	660	8	60

Ø E = External diameter (mm) Ø I = Internal diameter (mm) End length 150 mm

For color options, add the following suffixes to part no.:

 NEU = Neutral **BLU** = Blue **AZZ** = Sky-blue **ARA** = Orange

HD28
Tube cutter


	Tube
HD280012	2÷12
HD280025	12÷25

CHARACTERISTICS

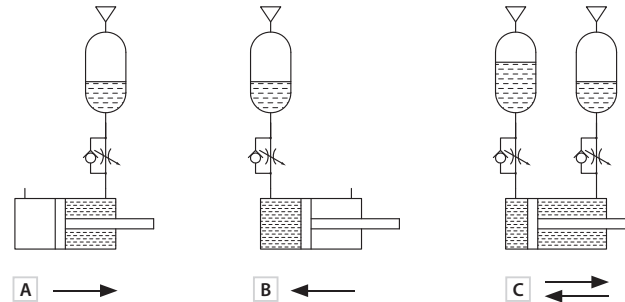
Ambient temperature	-20 ÷ 80 °C
Fluid	filtered air without lubrication, hydraulic oil
Working pressure	0 ÷ 8 bar
Size	100 mm
End-caps	technopolymer
Barrel	profiled and anodized aluminium
Piston	NBR

■ AM4



Part No.	Volume (dm3)	Weight (Kg)
AM41000060	0,6	1,1
AM41000080	0,8	1,3
AM41000120	1,2	1,7
AM41000160	1,6	2,2
AM41000200	2,0	2,6
AM41000240	2,4	3
AM41000280	2,8	3,4
AM41000320	3,2	3,9
AM41000360	3,6	4,3
AM41000400	4,0	4,7
AM41000440	4,4	5,1

OPERATING DIAGRAM



A-B-C = Regulation direction of piston rod's speed

- Fix the reservoir at a higher level than cylinder
- Reservoir's volume must be 20% bigger than cylinder's volume

Self-compensating

■ YDA



Part No.	Thread	Stroke (mm)	Max energy per cycle (Nm)	Max energy per hour (Nm)	Max effective mass (Kg)	Max impact speed (m/s)	Stop collar
YDA0806	M8 x 1	6	3	7000	6	0,3-2,5	YDG08
YDA1007	M10 x 1	7	6	12400	12	0,3-3,5	YDG10
YDA1210	M12 x 1	10	12	22500	22	0,3-4	YDG12
YDA1412	M14 x 1,5	12	20	33000	40	0,3-5	YDG14
YDA2015	M20 x 1,5	15	59	38000	120	0,3-5	YDG20
YDA2525	M25 x 1,5	25	80	60000	180	0,3-5	YDG25
YDA2725	M27 x 1,5	25	147	72000	270	0,3-5	YDG27

Special strokes upon request

Ambient temperature: -10 ÷ 85 °C

Body: steel

Piston rod: chromium-plated carbon steel

Piston: carbon steel

Adjustable

■ YDR



Part No.	Thread	Stroke (mm)	Max energy per cycle (Nm)	Max energy per hour (Nm)	Max effective mass (Kg)	Max impact speed (m/s)	Stop collars
YDR1415	M14 x 1,5	15	22	26400	80	3	YDG14
YDR2025	M20 x 1,5	25	39	39000	312	3,5	YDG20
YDR2525	M25 x 1,5	25	85	51000	400	3,5	YDG25
YDR2540	M25 x 1,5	40	100	84000	700	3,5	YDG25L
YDR3625	M36 x 1,5	25	150	90000	1400	3,2	YDG36
YDR3650	M36 x 1,5	50	300	108000	1400	3,2	YDG36

Special strokes upon request

Ambient temperature: -10 ÷ 85 °C

Body: steel

Piston rod: chromium-plated carbon steel

Piston: carbon steel

Pressure gauge

HZ9P


Thread: brass, copper alloy
Body: technopolymer
Movement: brass
Indicator: aluminium, black painted
Dial: acrylic pressure mounted
Accuracy: EN 837 class 2,5. ASME B40.1 grade B
Protection: IP 43

Part No.	Ø	Scale		Thread
		Bar	MPa	
HZ9P400318	40	0 - 2,5	0 - 0,25	R1/8
HZ9P400618	40	0 - 6	0 - 0,6	R1/8
HZ9P401018	40	0 - 10	0 - 1	R1/8
HZ9P500314	50	0 - 2,5	0 - 0,25	R1/4
HZ9P500614	50	0 - 6	0 - 0,6	R1/4
HZ9P501014	50	0 - 10	0 - 1	R1/4
HZ9P630314	63	0 - 2,5	0 - 0,25	R1/4
HZ9P630614	63	0 - 6	0 - 0,6	R1/4
HZ9P631014	63	0 - 10	0 - 1	R1/4

Pressure gauge with flange for panel mounting

HZ9PB


Thread: brass, copper alloy
Body: metal, black painted
Assembly: chromium plated front flange with 3 holes
Movement: brass
Indicator: aluminium, black painted
Dial: acrylic
Accuracy: EN 837 class 2,5. ASME B40.1 grade B
Protection: IP 43

Part No.	Ø	Scale		Thread
		Bar	MPa	
HZ9PB400318	40	0 - 2,5	0 - 0,25	R1/8
HZ9PB400618	40	0 - 6	0 - 0,6	R1/8
HZ9PB401018	40	0 - 10	0 - 1	R1/8
HZ9PB500314	50	0 - 2,5	0 - 0,25	R1/4
HZ9PB500614	50	0 - 6	0 - 0,6	R1/4
HZ9PB501014	50	0 - 10	0 - 1	R1/4
HZ9PB630314	63	0 - 2,5	0 - 0,25	R1/4
HZ9PB630614	63	0 - 6	0 - 0,6	R1/4
HZ9PB631014	63	0 - 10	0 - 1	R1/4

Pressure gauge with bracket for panel mounting

HZ9PBS


Thread: brass, copper alloy
Body: metal, black painted
Assembly: border with rear bracket
Movement: brass
Indicator: aluminium, black painted
Dial: acrylic
Accuracy: EN 837 class 2,5. ASME B40.1 grade B
Protection: IP 43

Part No.	Ø	Scale		Thread
		Bar	MPa	
HZ9PBS400318	40	0 - 2,5	0 - 0,25	R1/8
HZ9PBS400618	40	0 - 6	0 - 0,6	R1/8
HZ9PBS401018	40	0 - 10	0 - 1	R1/8
HZ9PBS500314	50	0 - 2,5	0 - 0,25	R1/4
HZ9PBS500614	50	0 - 6	0 - 0,6	R1/4
HZ9PBS501014	50	0 - 10	0 - 1	R1/4
HZ9PBS630314	63	0 - 2,5	0 - 0,25	R1/4
HZ9PBS630614	63	0 - 6	0 - 0,6	R1/4
HZ9PBS631014	63	0 - 10	0 - 1	R1/4

Recessed pressure gauge

HZ9464G


Body: tecnopolymer
Assembly: HZE series regulator and filter regulator size 0-05-1-2
Scale: 0 ÷ 12 bar
Dial: polycarbonate
Accuracy: ± 3% full scale

The screws are not included

CHARACTERISTICS

		HZ9NC Vacuum switch	HZ9NP Pressure switch
Ambient temperature		0 ÷ 50 °C	
Fluid		filtered air, inert gases non-corrosive non-flammable	
Working pressure		-1 ÷ 1 bar	0 ÷ 10 bar
Pressure range		-1 ÷ 1 bar	-1 ÷ 10 bar
Max. pressure		3 bar	15 bar
Set pressure resolution	kPa	0,1	-
	MPa	-	0,001
	kgf/cm ²	0,001	0,01
	bar	0,001	0,01
	psi	0,01	0,1
	inHg	0,1	-
Hysteresis		adjustable ^(A)	
Weight		about 80 g (with 2 mt lead wire), about 45g (with M8 connector)	

(A) = Hysteresis value is adjustable within 1 ÷ 8 digits for one point set mode and window comparator mode



CODIFICATION KEY

H	Z	9	N	P	0	4	M	0	8
1	2	3	4						

1 Series HZ9N = Digital Pressure switch/Vacuum switch Standard version 2 meters cable	2 Pressure range C = Vacuum switch - Compound (-1 ÷ 1 bar) P = Pressure switch - Positive (-1 ÷ 10 bar) P40 = Pressure switch - Positive (0 ÷ 10 bar) HZE regulator and filter-regulator assembly	3 Output signal 010 = 1 NPN output + 1 analog output (1-5V) 011 = 1 NPN output + 1 analog output (4-20mA) 02 = 2 NPN outputs 030 = 1 PNP output + 1 analog output (1-5V) 031 = 1 PNP output + 1 analog output (4-20mA) 04 = 2 PNP outputs
4 Options M08 = M8 4 Pin male (Standard) M12 = M12 4 Pin male (upon request)		

ELECTRICAL CHARACTERISTICS

Power supply voltage		12 ÷ 24V DC ± 10%, ripple max ≤ 10%
Switch output	PNP/NPN	open collector 2 outputs
	Max. load current/supply voltage	125 mA/24 V DC
	Residual voltage	≤ 1,5 V
Repeatability (switch output)		± 0,2% F.S. ± 1 digit
Analog output (voltage output)	Voltage	1-5 V ± 2,5% F.S.
	Linearity	≤ ± 1% F.S.
	Output impedance	about 1k Ω
	Current	4 ÷ 20 mA ± 2,5% F.S.
Analog output (current output)	Linearity	≤ ± 1% F.S.
	Max./Min. load impedance	300 Ω a 12 V DC, 600 Ω a 24 V DC/50 Ω
Environment	Enclosure	IP40
	Storage temperature	-10 ÷ 60°C (no condensation or freezing)
	Humidity	35 ÷ 85% relative humidity (no condensation)
	Withstand voltage	1000 V AC in 1-min between case and lead wire
	Insulation resistance	≥ 50 MΩ (a 500 V DC, between case and lead wire)
	Vibration	total amplitude 1,5 mm o 10G, 10Hz ÷ 150Hz, 10Hz for 1 minute, 2 hours direction X,Y and Z
	Shock	100m/s ² (10G), 3 times direction X,Y and Z
Connections		R1/8 - M5F
Temperature characteristic		± 2% F.S. of detected pressure (25°C) at temperature range of 0-50°C

HZ9N1F	HZ9N2F	HZ9NM08-0200	DHF-...
Adapter for panel assembly + protection cap	Supports (2 pcs)	M8 Extension 2m Cable	In-line M12 connection 3m cable DHF-033M12 In-line M12 connection 5m cable DHF-053M12

CHARACTERISTICS

		HZ9NC50 Vacuum switch	HZ9NP50 Pressure switch
Ambient temperature		0 ÷ 50 °C	
Fluid		filtered air, inert gases non-corrosive non-flammable	
Working pressure		-1 ÷ 1 bar	0 ÷ 10 bar
Pressure range		-1 ÷ 1 bar	-1 ÷ 10 bar
Max. pressure		3 bar	15 bar
Set pressure resolution	kPa	0,1	-
	MPa	-	0,001
	kgf/cm ²	0,001	0,01
	bar	0,001	0,01
	psi	0,01	0,1
	InHg	0,1	-
Hysteresis		adjustable ^(A)	
Weight		about 86 g	



(A) = Hysteresis value is adjustable within 1 ÷ 8 digits for one point set mode and window comparator mode

CODIFICATION KEY

H	Z	9	N	P	5	0	0	1	0			
1	2	3	4	5								

1 Series HZ9N = Digital Pressure switch/ Vacuum switch Standard version 2 m cable	2 Pressure range C = Vacuum switch - Compound (-1 ÷ 1 bar) P = Pressure switch - Positive (0 ÷ 10 bar)	3 Type 50 = IP65
--	---	----------------------------

4 Output signal 010 = 2 NPN outputs + 1 analog output (1-5V) 011 = 2 NPN outputs + 1 analog output (4-20mA) 02 = 2 NPN outputs + copy function 030 = 2 PNP outputs + 1 analog output (1-5V) 031 = 2 PNP outputs + 1 analog output (4-20mA) 04 = 2 PNP outputs + copy function	5 Options L05 = Cable 5 m
--	-------------------------------------

ELECTRICAL CHARACTERISTICS

Power supply voltage		12 ÷ 24V DC ± 10%, ripple max ≤ 10%
Switch output	PNP/NPN	open collector 2 outputs
	Max. load current/supply voltage	125 mA/24 V DC
	Residual voltage	≤ 1,5 V
Repeatability (switch output)		≤ ± 0,2% F.S. ± 1 digit
Analog output (voltage output)	Voltage	1-5 V ± ± 2,5% F.S.
	Linearity	≤ ± 1% F.S.
	Output impedance	about 1k Ω
	Current	4 ÷ 20 mA ± ± 2,5% F.S.
Analog output (current output)	Linearity	≤ ± 1% F.S.
	Max./Min. load impedance	250 Ω a 12 V DC, 600 Ω a 24 V DC/50 Ω
Environment	Enclosure	IP65
	Storage temperature	-10 ÷ 60°C (no condensation or freezing)
	Humidity	35 ÷ 85% relative humidity (no condensation)
	Withstand voltage	1000 V AC in 1-min between case and lead wire
	Insulation resistance	≥ 50 MΩ (a 500 V DC, between case and lead wire)
	Vibration	total amplitude 1,5 mm o 10G, 10Hz ÷ 150Hz, 10Hz for 1 minute, 2 hours direction X,Y, Z
	Shock	100m/s ² (10G), 3 times direction X,Y, and Z
Connections		R1/8 - M5F
Temperature characteristic		± 2,5% F.S. of detected pressure (25°C) at temperature range of 0-50°C

HZ9N1F-50	HZ9N2F-51	HZ9N2F-52
Adapter for panel assembly + protection cap	Support	Support

CHARACTERISTICS

Ambient temperature	0 ÷ 50 °C	
Fluid	filtered air, inert gases non-corrosive non-flammable	
Working pressure	0 ÷ 10 bar	
Pressure range	-1 ÷ 10 bar	
Max. pressure	15 bar	
Set pressure resolution	MPa	0,001
	kgf/cm ²	0,01
	bar	0,01
	psi	0,1
Hysteresis	adjustable ^(A)	
Weight	about 80g (with 2 meters lead wire), about 45g (with M8 connector)	

HZ9NP4004: 2m cable version

HZ9NP4004M8: M8 connection version including 2 meter extension cable

(A) = Hysteresis value is adjustable within 1 ÷ 8 digits for one point set mode and window comparator mode



ELECTRICAL CHARACTERISTICS

Power supply voltage	12 ÷ 24V DC ± 10%, ripple max ≤ 10%	
Current consumption	≤ 40mA (with no load)	
Switch output	PNP/NPN	open collector 1 output
	Max. load current	125 mA
	Max. supply voltage	24 V DC
	Residual voltage	≤ 1,5 V
Repeatability (switch output)	≤ ± 0,2% F.S. ± 1 digit	
Response time	≤ 2,5 ms (chattering-proof function: 25ms, 100 ms, 250 ms, 500 ms, 1000 ms, 1500 ms selectable)	
Output short circuit protection	yes	
7 segment LCD display	main display digit 3 ^{1/2} two colors (red/green)	
	secondary display digit 3 ^{1/2} orange (sampling rate: 5 volte/sec.)	
Indicator accuracy	≤ ± 2% F.S. ± 1 digit (ambient temperature: 25 ± 3°C)	
Switch ON indicator	orange output 1 and 2	
Environment	Enclosure	IP40
	Storage temperature	-10 ÷ 60°C (no condensation or freezing)
	Humidity	35 ÷ 85% relative humidity (no condensation)
	Withstand voltage	1000 V AC in 1-min between case and lead wire
	Insulation resistance	≥ 50 MΩ (a 500 V DC, between case and lead wire)
	Vibration	total amplitude 1,5 mm o 10G, 10Hz ÷ 150Hz, 10Hz for 1 minute, 2 hours direction X,Y and Z
Shock	100m/s ² (10G), 3 times direction X,Y and Z	
Temperature characteristic	± 2% F.S. of detected pressure (25°C) at temperature range of 0-50°C	
Lead wire	Oil-resistance cable (0,15 mm ²)	

HZ9N0M

HZ9N1M

DHF...M08



Adapter
Size 0-05-3

Supplied with screws:
M3x12 size 0-05
M2,5x12 size 3



Adapter
Size 1-2

Supplied with screws:
M3x20



In-line M08 connection 3m cable
DHF-033M08

In-line M08 connection 5m cable
DHF-053M08

HZ9N12



Max pressure: 80 bar
 Max temperature: -10 ÷ 120 °C
 Max voltage: 250 V AC
 Max current: 0,5 A
 Body: brass

Version with NC - NC/NO contact upon request

Part No.	Adjustable range (bar)	Tolerance 20° C (bar)	Contact	Thread
HZ9N12110060	1 - 10	± 0,5	NO	R1/8
HZ9N12110080	1 - 10	± 0,5	NO	R1/4
HZ9N12111060	0,1 - 1	± 0,1	NO	R1/8
HZ9N12111080	0,1 - 1	± 0,1	NO	R1/4

ATEX



ATEX version available
 For further information please contact our Sales Office

HZ9N12A

HZ9N12B

HZ9N12C



Protection cap
IP54



Protection connector
IP65



Protection connector
IP65 DIN

DF



Other available versions (M08-M12)

- DF-220M08 DF-220M12
- DF-330M08 DF-330M12
- DF-440M08 DF-440M12
- DF-770M08 DF-770M12

With 5 meters cable

- DF-220L5
- DF-330L5

With 10 meters cable

- DF-220L10
- DF-330L10

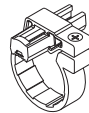
Cable extensions

- DHF-033 M08 = 3 m M08
- DHF-033 M12 = 3 m M12
- DHF-053 M08 = 5 m M08
- DHF-053 M12 = 5 m M12

Type	ELECTROMECHANICAL REED			ELECTRONIC PNP
	DF-220	DF-330*	DF-440	DF-770
Part No.				
Working voltage (V AC/DC)	5±30 V AC/DC	5±30 V AC/DC	5±30 V AC/DC	5±30 V DC
Max switching current (mA)	100	100	100	100
Max switching power (W/VA)	3	3	3	3
Max voltage drop (V AC/DC)	<3,5	0,1	0,1	0,7
Minimum magnetic field (gauss)	60	60	60	30
Opening response time (ms)	< 0,5	< 0,5	< 0,5	0,08
Closing response time (ms)	< 1	< 1	< 1	0,03
Electric life with resistive load (cycles)	>10 ⁷	>10 ⁷	>10 ⁷	>10 ⁹
State indicator (LED)	red	red	red	red
Cable number and section (mmq)	2x0,14	3x0,14	3x0,14	3x0,14
Cable length (mm)	3000	3000	3000	3000
Electric circuit	A	C	D	C
Protection degree (EN60529)	IP67			
Working temperature (°C)	-20 ÷ +80			

*: NPN upon request (DF-330NPN 3 meters cable)

■ Fixing elements

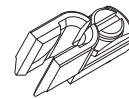


- DH-M10DF DH-M20DF
- DH-M12DF DH-M25DF
- DH-M16DF

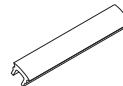
Fixing bracket for M series cylinders



- DH-K320DF
- Fixing bracket for K320 series cylinders



- DF-001
- Cable clamping

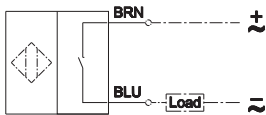


- DHF-0020100
- Covering strip

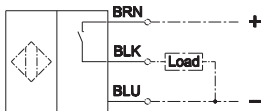
Electrical Circuit

Version with cable

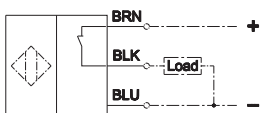
A AC/DC 2 wires NO



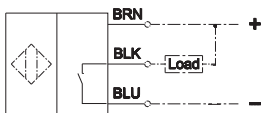
C DC 3 wires PNP NO



D DC 3 wires PNP NC



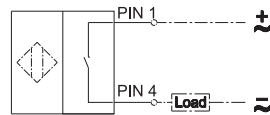
E DC 3 wires PNP NC



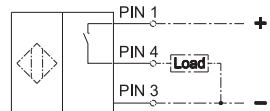
BRN = Brown
BLK = Black
BLU = Blue

Version with connector

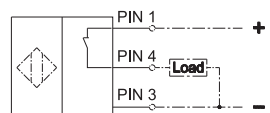
A AC/DC 2 wires NO



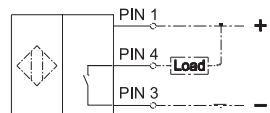
C DC 3 wires PNP NO



D DC 3 wires PNP NC

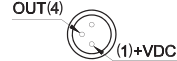


E DC 3 wires PNP NC



PIN 1 = Brown
PIN 2 = White
PIN 3 = Blue
PIN 4 = Black

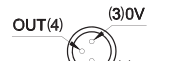
M08 2 wires



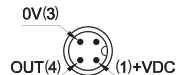
M12 2 wires



M08 3 wires



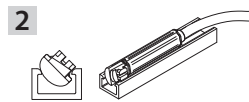
M12 3 wires



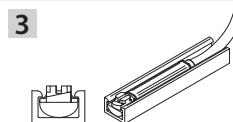
Assembly Scheme



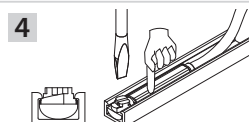
Put the sensor in the proper groove and make sure that the fastening plate has the slot for screwdriver along the sensor axis.



Put the sensor inside its groove and make sure that the fastening plate is on the open part of the groove.



Check the correct position of the sensor in the groove. Turn it to the wished position for detection.



Keep the sensor in its position and screw the fastening plate to fix the sensor in the groove.
Max torque: 0,5 ÷ 1 Nm

DH



Other available versions (M08-M12)

- DH-200M08 DH-200M12
- DH-500M08 DH-500M12
- DH-700M08 DH-700M12

Cable extensions

- DHF-033 M08 = 3 m M08 (max 60 V)
- DHF-033 M12 = 3 m M12
- DHF-053 M08 = 5 m M08 (max 60 V)
- DHF-053 M12 = 5 m M12

With 5 meters cable With 10 meters cable

- DH-200L5 DH-200L10
- DH-500L5 DH-500L10
- DH-700L5 DH-700L10

Type	ELECTROMECHANICAL REED			ELECTRONIC PNP
	Part No.	KM-032000	DH-200	DH-500
Working voltage (V AC/DC)	5÷250 V AC/DC	5÷250 V AC/DC	5÷250 V AC/DC	10÷30 V DC
Max switching current (mA)	1000	200	200	200
Max switching power (W/VA)	30	10	10	5
Max voltage drop (V AC/DC)	< 3,5	< 3,5	< 3,5	0,7
Minimum magnetic field (gauss)	85	85	60	30
Opening response time (ms)	< 0,5	< 0,5	< 0,5	0,08
Closing response time (ms)	< 1	< 1	< 1	0,03
Electric life with resistive load (cycles)	>10 ⁷	>10 ⁷	>10 ⁷	>10 ⁹
State indicator (LED)	red	red	red	red
Cable number and section (mmq)	2x0,25	2x0,25	2x0,25	3x0,25
Cable length (mm)	3000	3000	3000	3000
Electric circuit	A	A	A	C
Protection degree (EN60529)	IP65			
Working temperature (°C)	-20 ÷ +80			

■ Fixing elements



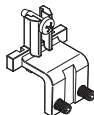
- DH-M10 DH-M20
- DH-M12 DH-M25
- DH-M16

Fixing bracket for M series cylinders



- DH-K032050
- DH-K063125
- DH-K160200
- DH-K250

Fixing bracket for K series cylinders



- KM-032050-1
- KM-063100-1
- KM-125000-1

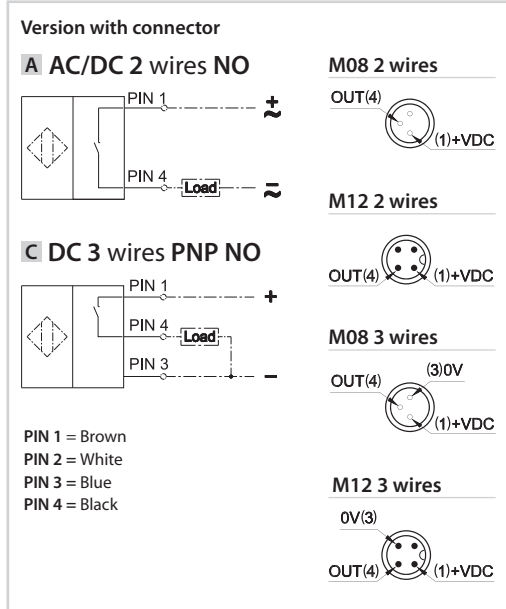
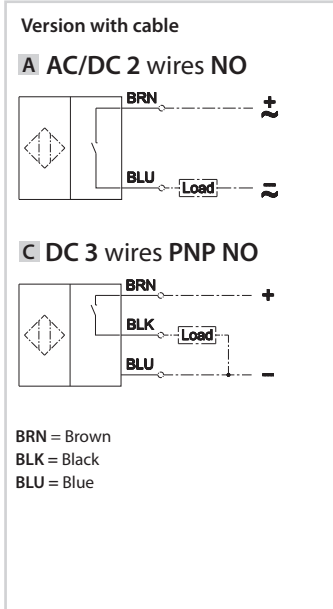
Fixing bracket for KM sensors on ISO cylinders (upon request)



- DH-S25
- DH-S32
- DH-S40
- DH-S50

Fixing bracket for S1 series rodless cylinders

Electrical Circuit



Available ATEX version upon request
See ATEX Catalogue for types and versions

DF-T



Type	ELECTROMECHANICAL REED		ELECTRONIC PNP	
	DF-T200L03	DF-T200M08	DF-T700L03	DF-T700M08
Part No.				
Working voltage (V AC/DC)	5÷120 V AC/DC	5÷120 V AC/DC	5÷30 V DC	5÷30 V DC
Max switching current (mA)	100	100	200	200
Max switching power (W/VA)	10	10	6	6
Working temperature (°C)	-10 ÷ +70			
Max voltage drop (V AC/DC)	2,5	2,5	1	1
Cable number and section (mmq)	2 x 2,8 (PUR)	2 x 2,8 (PUR)	3x2,8 (PUR)	3x2,8 (PUR)
Cable length (mm)	3000	300	3000	300
Contact	NO	NO	NO	NO
Max response time (ms)	1	1	1	1
State indicator (LED)	red	red	green	green
Electric circuit	A	-	C	-
Protection degree (NEMA 6)	IP67			
Shock resistance (G)	30	30	50	50

Cable extensions

DHF-033M08 = 3 m M08 (max 60 V)

DHF-053M08 = 5 m M08 (max 60 V)

Cylinder series

DF-T:

JX1, JX2, YMA20, YMP20, YMP30, YMP50 (Ø16÷25), JLE (Ø12), YR3

DF-T + DF-R002:

JTES, JTEV, YMA11, YMP40, YMP50 (Ø32÷63)

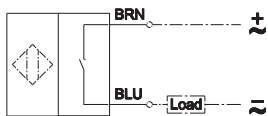
DF-T + DF-R003:

JLE (Ø16÷63)

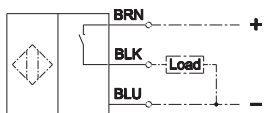
Electrical Circuit

Version with cable

A AC/DC 2 wires NO



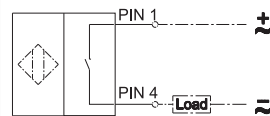
C DC 3 wires PNP NO



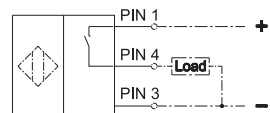
BRN = Brown
BLK = Black
BLU = Blue

Version with connector

A AC/DC 2 wires NO

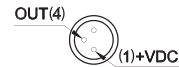


C DC 3 wires PNP NO



PIN 1 = Brown
PIN 2 = White
PIN 3 = Blue
PIN 4 = Black

M08 2 wires



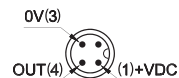
M12 2 wires



M08 3 wires



M12 3 wires



DF-RW


Cable extensions
 DHF-033M12 = 3 m M12 (max 6 V)
 DHF-053M12 = 5 m M12 (max 6 V)

Type	ELECTRONIC	
Part No.	DF-RW700L03	DF-RW700M12
Working voltage (V DC)	10÷28 V DC	10÷28 V DC
Max switching current (mA)	5÷50	5÷50
Max switching power (W)	1,5	1,5
Working temperature (°C)	-10 ÷ +60	
Max voltage drop (V AC/DC)	5	5
Cable number and section (mmq)	2x4,8 (PUC)	2x4,8 (PUC)
Cable length (mm)	3000	500
Contact	NO	NO
Max response time (ms)	50	50
State indicator (LED)	red (detection position) verde (optimal detection position)	
Protection degree IEC 60529)	IP67	
Shock resistance (G)	50	50

Cylinder series

DF-RW:

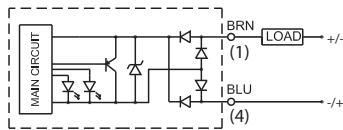
JX1, JX2, YMA20, YMP20, YMP30, YMP50 (Ø16÷25), JLES (Ø12), JLEV (Ø12), YR3 DF-T

DF-RW + DF-R002:

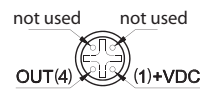
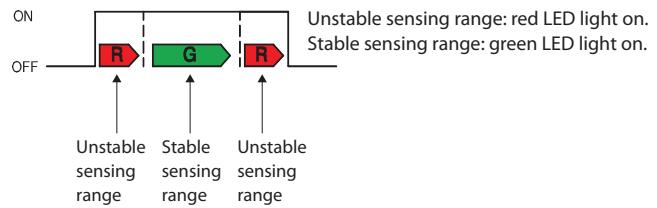
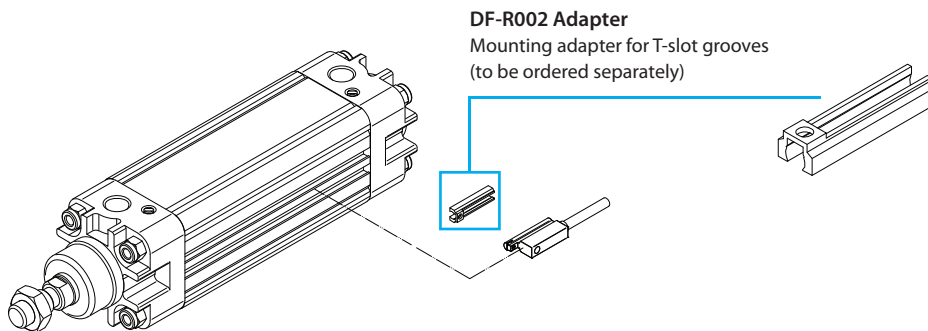
M, KE, KD, KL, RP, RO, RS, RQ, OV, R, W, JTES, JTEV, YMA11, YMP40, YMP50 (Ø32÷63)

DF-RW + DF-R003:

JLE (Ø16÷63)

Electrical Circuit


BRN = Brown
 BLU = Blue

M12

Two color indication

Mounting scheme


DF-MA



Continuous detection sensor of the piston rod's position, for direct mounting on cylinders with T-slot fixing or tie rods with appropriate support brackets.

- ISO 15552 - KE/KD/KL series
- UNITOP - RP/RO series
- ISO 21287 - RM/RN series
- STRONG - RS/RQ series
- OVALI - OV series
- CORSA BREVE - W series

Analog and IO-Link exit standard supplied.

Integrated button for regulation measuring range and selection of analog exit.

Type	ANALOG/IO-LINK
Part no.	DF-MA
Stroke measuring range (± 1 mm)	287÷1007 mm depending on the model
Voltage	15÷30 V DC ripple max $\leq 10\%$
Type of connection	M8 male 4P
Sampling time	1,15 ms ^(C)
Resolution	0,03% FS ($\geq 0,06$ mm) ^(A)
Linearity	0,5 mm
Repeatability ^(B)	0,06% FSR ($\geq 0,1$ mm) ^(A)
Cylinder's traslation speed	< 3 m/s
Exit function	analog: 0÷10 V IO-Linnk : 4-20 mA
Overload protection	YES
Short circuit protection	YES
Reverse polarity protection	YES
Max. load resistance (output current)	$\leq 500 \Omega$
Min. load resistance (output voltage)	≥ 2 K Ω
Power consumption (without loading)	35 mA
Protection class	III
Protection degree	IP65 a norma EN 60529, IP67, IP68
Electromagnetic compatibility	according EN 60947-5-7
Shock	30g/11 ms
Vibrations	total amplitude 1 mm, 10÷55 Hz
Ambient temperature	-20÷+70°C
Container material	aluminium, PA polyamide
LED, operating indication	yellow/red
LED, analog indication	voltage: green current: blue

A) FS: Full-scale C) Only during the standard functioning
 B) T = 25 °C, 24 V DC non IO-Link

CODIFICATION KEY



1 Series	2 Measuring range	3 Connection
DF-MA = Magnetic position sensor	0287 = 287 mm 0539 = 539 mm 0791 = 791 mm 0323 = 323 mm 0575 = 575 mm 0827 = 827 mm 0359 = 359 mm 0611 = 611 mm 0863 = 863 mm 0395 = 395 mm 0647 = 647 mm 0899 = 899 mm 0431 = 431 mm 0683 = 683 mm 0935 = 935 mm 0467 = 467 mm 0719 = 719 mm 0971 = 971 mm 0503 = 503 mm 0755 = 755 mm 1007 = 1007 mm	M08 = M8 connector analog exit and IO-Link

Electrical connections

M08	No. Pin	Cable	Analog exit M8/IO-Link connector
	1	Brown	15÷30 V DC
	2	White	4-20 mA
	3	Blue	0 V
	4	Black	0÷10 V IO-LINK



DHF-P24M08
M8 in-line connector 2 meters cable
DHF-P54M08
M8 in-line connector 5 meters cable

Sensor mounting bracket on cylinders with T-slot fixing
Detection area:
 287÷431 mm (3pcs) 683÷791 mm (5pcs)
 467÷647 mm (4pcs) 827÷1007 mm (6pcs)










Sensor mounting bracket for cylinders series K ($\varnothing 160\div 320$ mm)

Automotive

6

Clamping Technology



	Pneumatic and Manual Power clamps	UCBP UCBM UCBH UCBQ UCIP UCIM	UCBT UCDP UCBL UCNP UCNM	4
	Pneumatic Power clamps	UABP UABM UANP UANM		5
	Retractable locating pin units	ULB ULP ULR ULM ULL ULA	ULO ULZ ULY ULT ULX	5/6
	Pin clamps	USP USS USSL USC USR	UST USP50U LUP USL	7
	Gripper units	UGP UGM UGPS		7
	Power pivots	UAGP		8
	Marking units	UPD UPR		8
	Electrical units	LAE LNE LCE LGE LAGE UAEP		9
	Accessories	TC-E UBK UBF CLAMPING ARMS DF-K/DF-S		9/10



STEPLESS ADJUSTMENT

Opening angle adjustment 0 ÷ 135°

LIGHT-WEIGHT

Clamping arm and clamp housing in aluminium alloy

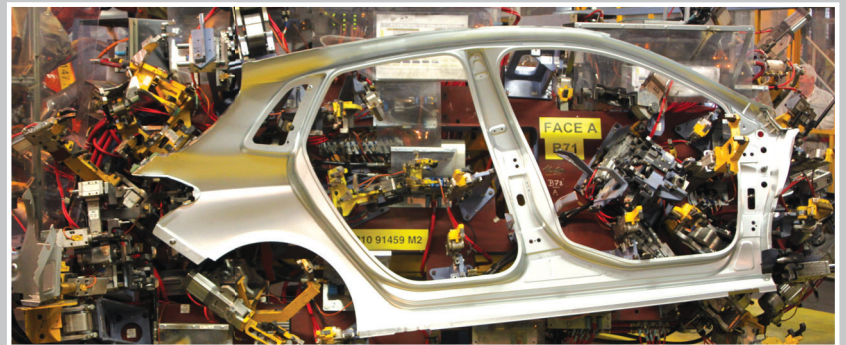
UNIVER ORIGINAL LINKAGE DESIGN

Ensures positional repeatability

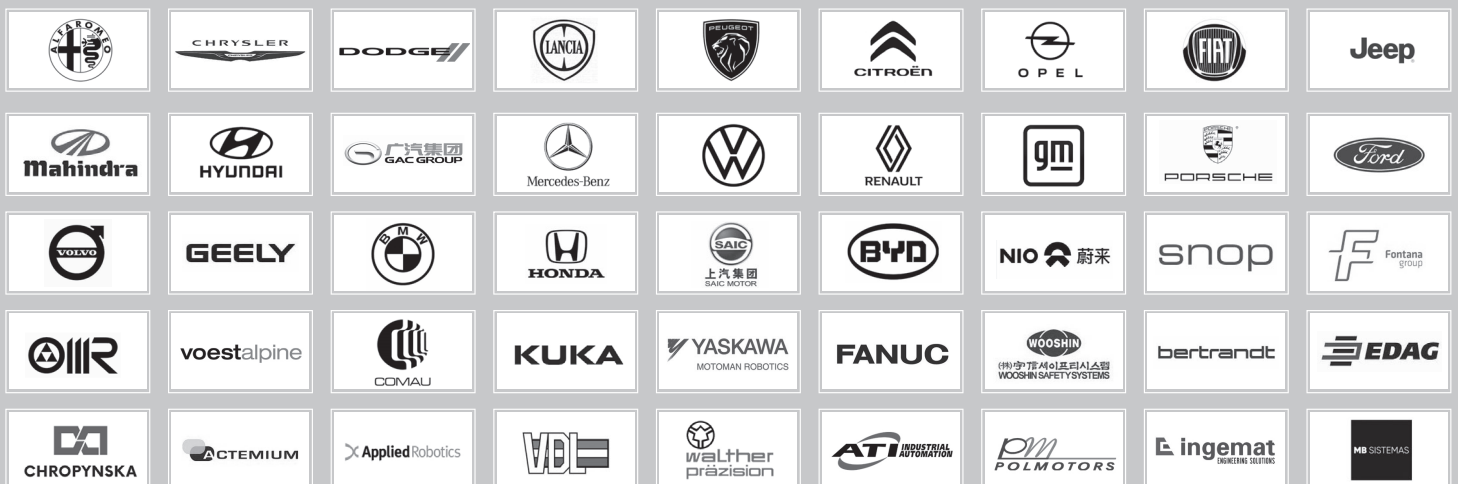
UNIVER ORIGINAL METAL SENSOR

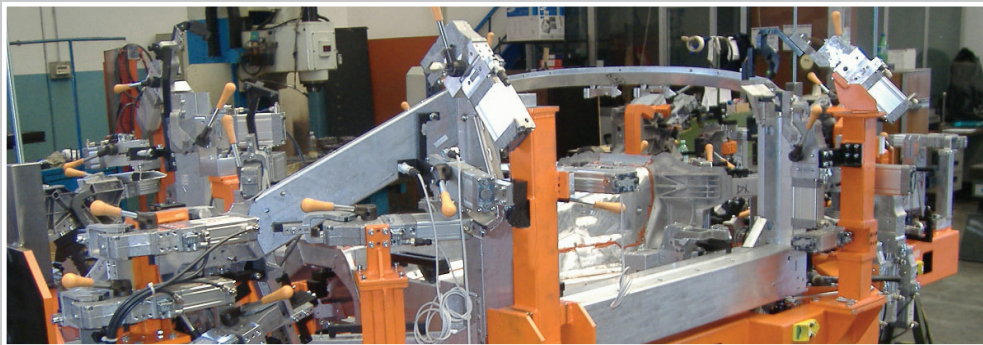
Metal case
M12 swivel connector

UNIVER Power Clamps meet the requirements of the Automotive and sheet metal industries; they are mostly used for sheet metal handling, BIW applications and welding fixtures production.



CNOMO clamps' applications





Pneumatic power clamps' applications



Electric power pivots' applications



Pneumatic and Manual power clamps **UNICLAMP**

6

UCBP

Pneumatic power clamp miniclamp Ø 25 - 32



Ø Cylinder mm: 25 - 32
Fully adjustable opening angle

UCBM

Pneumatic power clamp miniclamp Ø 25 - 32 with hand lever



Ø Cylinder mm: 25 - 32
Fully adjustable opening angle

UCBP/UCBH

Pneumatic power clamp Ø 40 - 50 - 63 - 80



Ø Cylinder mm: 40 - 50 - 63 - 80
Fully adjustable opening angle

UCBM/UCBQ

Pneumatic power clamp Ø 40 - 50 - 63 - 80 with hand lever



Ø Cylinder mm: 40 - 50 - 63 - 80
Fully adjustable opening angle

UCIP

Pneumatic power clamp Ø 40 interchangeable with size 50/63 mm



Ø Cylinder mm: 40
Fully adjustable opening angle

UCIM

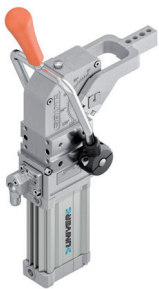
Pneumatic power clamp Ø 40 interchangeable with size 50/63 mm with hand lever



Ø Cylinder mm: 40
Fully adjustable opening angle

UCBT

Pneumatic power clamp Ø 40 with central hand lever



Ø Cylinder mm: 40
Fully adjustable opening angle

UCDP

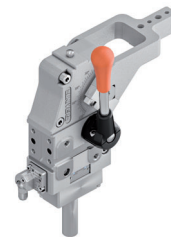
Pneumatic power clamp Ø 40 - 63 with 2 arms



Ø Cylinder mm: 40 - 63
Fully adjustable opening angle

UCBL

Manual power clamp size 50/63 with adjustable angle



UCNP

Pneumatic power clamp Ø 50 - 63 - 80 N.A.A.M.S. standard



Ø Cylinder mm: 50 - 63 - 80
Fully adjustable opening angle

UCNM

Pneumatic power clamp Ø 50 - 63 - 80 N.A.A.M.S. standard with hand lever



Ø Cylinder mm: 50 - 63 - 80
Fully adjustable opening angle

Pneumatic Power clamps **BLUECLAMP** - air saving

UABP

Pneumatic power clamp size 32 - 40 - 50 - 63 - 80



Ø Cylinder mm: 25 - 32 - 40 - 50 - 63
Fully adjustable opening angle

UABM

Pneumatic power clamp size 40 - 50 - 63 - 80 with hand lever



Ø Cylinder mm: 32 - 40 - 50 - 63
Fully adjustable opening angle

UANP

Pneumatic power clamp size 50 - 63 - 80 N.A.A.M.S. standard



Ø Cylinder mm: 40 - 50 - 63
Fully adjustable opening angle

UANM

Pneumatic power clamp size 50 - 63 - 80 N.A.A.M.S. standard with hand lever



Ø Cylinder mm: 40 - 50 - 63
Fully adjustable opening angle

Pneumatic and manual retractable locating pin units, single rod **UNICLAMP**

ULB

Compact pneumatic retractable locating pin unit size 32 with double guide, rear sensor



Stroke mm: 20 - 40

ULP

Pneumatic retractable locating pin unit Ø 32 - 50 - 63



Ø Cylinder mm: 32 - 50 - 63
Stroke mm: 20 - 40 (Ø32) 15 - 25 - 40 - 50 - 60 - 75 - 100 - 110 (Ø50) 15 - 25 - 40 - 50 - 60 (Ø63)

ULR

Compact pneumatic retractable locating pin unit Ø 50 - 63



Ø Cylinder mm: 50 - 63
Stroke mm: 15 - 25 - 40 - 50 - 60

ULM

Pneumatic retractable locating pin unit Ø 50 with hand lever



Ø Cylinder mm: 50
Stroke mm: 20 - 40 - 50 - 60

ULL

Manual Retractable locating pin unit size 50

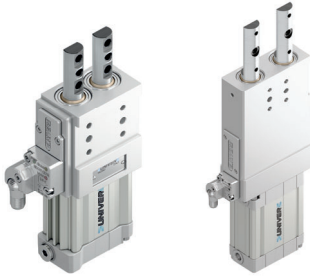


Stroke mm: 15 - 25 - 40 - 50 - 60

Pneumatic retractable locating pin units, double rod **UNICLAMP**

ULA

Pneumatic retractable locating pin unit Ø 40 - 63



Ø Cylinder mm: 40 - 63
Stroke mm: 20 - 40 (Ø40) 25 - 40 - 50 - 60 - 75
100 - 110 (Ø63)

ULO

Pneumatic retractable locating pin unit Ø50 with hand lever



Ø Cylinder mm: 50
Stroke mm: 40

6

Irreversible pneumatic retractable locating pin unit **UNICLAMP**

ULZ

Pneumatic retractable locating pin unit size 40 single rod



Stroke mm: 40

ULY

Pneumatic retractable locating pin unit size 40 single rod with hand lever



Stroke mm: 40

ULT

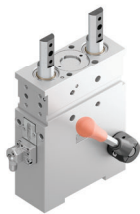
Pneumatic retractable locating pin unit size 50 double rod



Stroke mm: 40

ULX

Pneumatic retractable locating pin unit size 50 double rod with hand lever



Stroke mm: 40

Pneumatic pin clamps **UNICLAMP**

USP

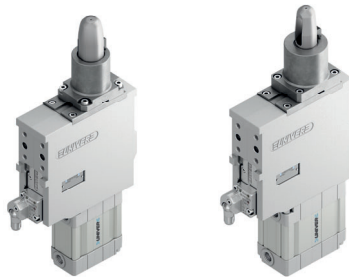
Pneumatic pin clamp \varnothing 32 - 50



\varnothing Cylinder mm: 32 - 50

USS

Pneumatic pin clamp \varnothing 50 - 63, orientable hook



\varnothing Cylinder mm: 50 - 63
 \varnothing 63 HIGH COMPENSATION

USSL

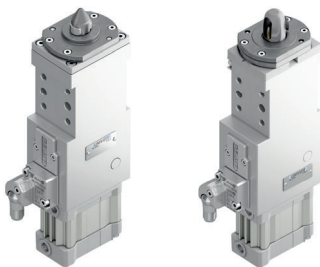
Pneumatic pin clamp \varnothing 50 for laser beam applications



\varnothing Cylinder mm: 50

USC/USR

Pneumatic compact pin clamp \varnothing 40



\varnothing Cylinder mm: 40

UST

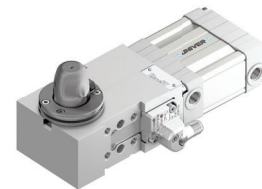
Pneumatic pin clamp \varnothing 50 with vanishing hook



\varnothing Cylinder mm: 50

USP50U

Pneumatic pin clamp- horizontal shape \varnothing 50



\varnothing Cylinder mm: 50

LUP

Pneumatic pin clamp \varnothing 63 with vanishing hook and pin



\varnothing Cylinder mm: 63

USL

Manual Pin clamp \varnothing 50



Gripper units **UNICLAMP**

UGP

Pneumatic gripper units \varnothing 40



\varnothing Cylinder mm: 40
Versions: single and double jaws movement
Fully adjustable opening angle

UGM

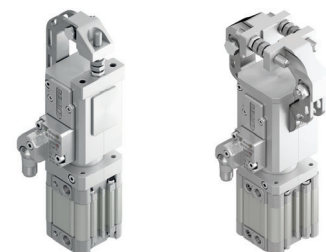
Pneumatic gripper unit \varnothing 40 with hand lever



\varnothing Cylinder mm: 40
Versions: single and double jaws movement
Fully adjustable opening angle

UGPS

Pneumatic gripper \varnothing 32 - 40

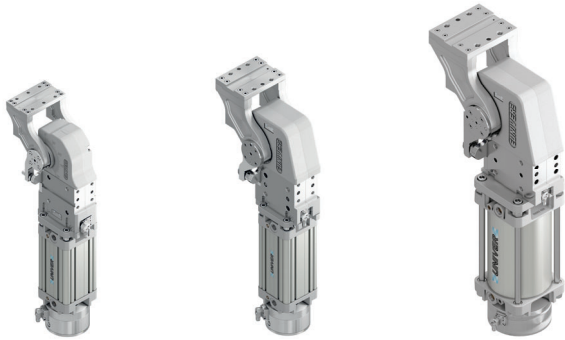


\varnothing Cylinder mm: 32 - 40
Versions: single and double jaws movement

Pneumatic power pivot UNICLAMP

UAGP_B

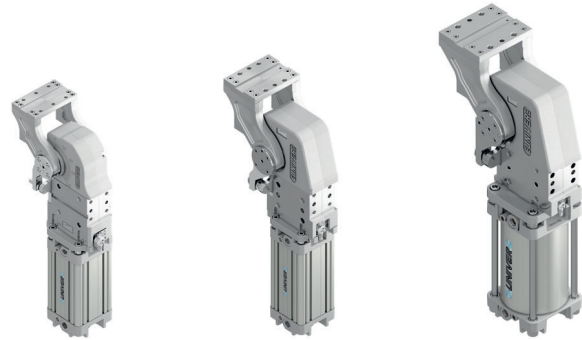
Pneumatic power pivot with brake, small - medium - large size



Small size: 16 - 60 - 110 - 170 Nm
 Medium size: 75 - 120 - 300 Nm
 Large size: 210 - 350 - 600 Nm

UAGP_W

Pneumatic power pivot without brake, small - medium - large size

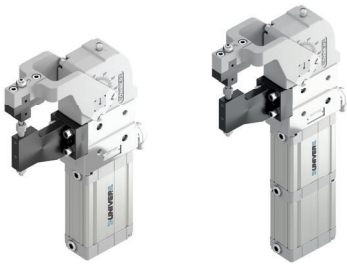


Small size: 16 - 60 - 110 - 170 Nm
 Medium size: 75 - 120 - 300 Nm
 Large size: 210 - 350 - 600 Nm

Pneumatic marking unit UNICLAMP

UPD

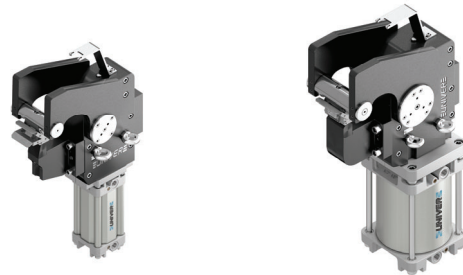
Pneumatic marking unit 250 Nm/500 Nm



Ø Cylinder mm: 63
 Version: single letter/number

UPR

Pneumatic marking unit with marking head 5000 Nm/12000 Nm



Ø Cylinder mm: 100
 Version: up to 7 letters/numbers

Ø Cylinder mm: 200
 Version: up to 8 letters/numbers

The marking head can be mounted on the lower mounting surface or on the upper moving arms

Electric unit **eCLAMP - ePIVOT**

LAE
Electric power clamps eCLAMP



Size: 140 - 225 - 350
Adjustable opening angle
Built in "obstruction" detection

LNE
Electric power clamps eCLAMP, N.A.A.M.S. standard



Size: 225 - 350
Adjustable opening angle
Built in "obstruction" detection

LCE
Electric retractable locating pin unit eCLAMP



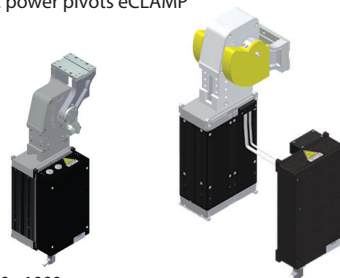
Size: 350
Adjustable stroke

LGE
Electric gripper units eCLAMP



Size: 140
Adjustable opening angle
Built in "obstruction" detection

LAGE
Electric power pivots eCLAMP



Size: 500 - 1000
Control module can be mounted remotely at 20 mt
The Integrated brake maintains the position any time power is lost

UAEP
Electric power pivot ePIVOT



Modular Control System

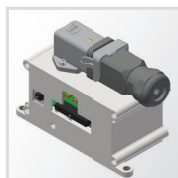
TC-E
Modular Control System for electric clamping units



SERIAL COMMUNICATION SYSTEM



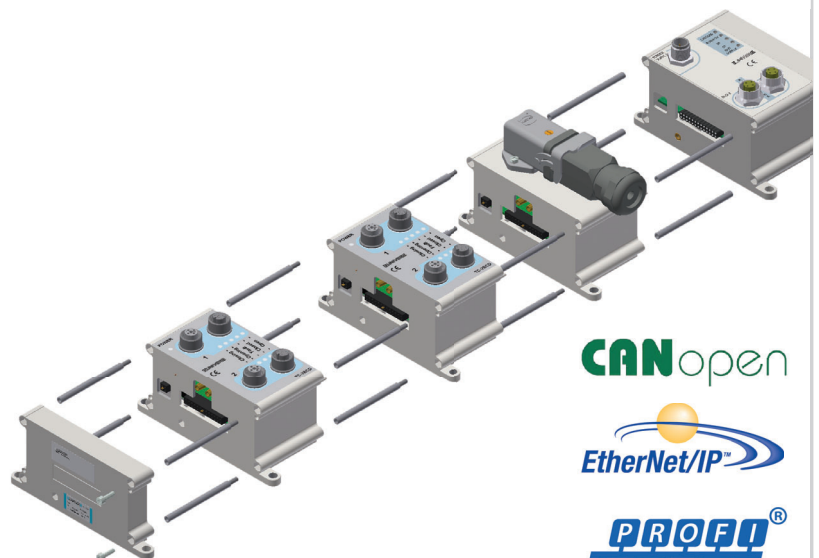
ELECTRIC UNIT DRIVER
Control module for 2 clamping units
Max 8 electric devices



POWER UNIT
EFFICIENT power management



FLEXIBLE
Compatible with I/O modules and valve manifolds



CANopen

EtherNet/IP

PROFI BUS

PROFI NET

EtherCAT

Accessories

UBK

Self-holding spring for open position



UBF

Ergonomic Handlevers



LKP/UKP/IKP/UP Clamping arms

Wishbone/Blade Arms conforming to the DIN or N.A.A.M.S. Standard



DF-K/DF-S

Electronic sensor

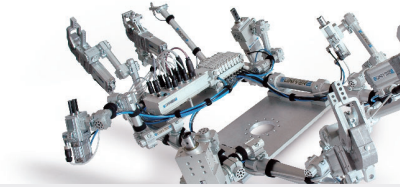


Offset mm: 0 - 15 - 25 - 45 - 50 - 70 - 75 - 105 - 120

Modular Tooling System

7

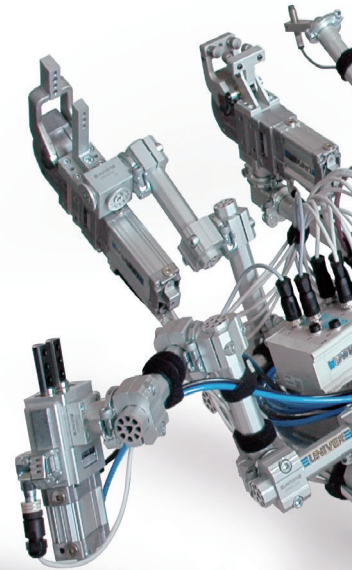
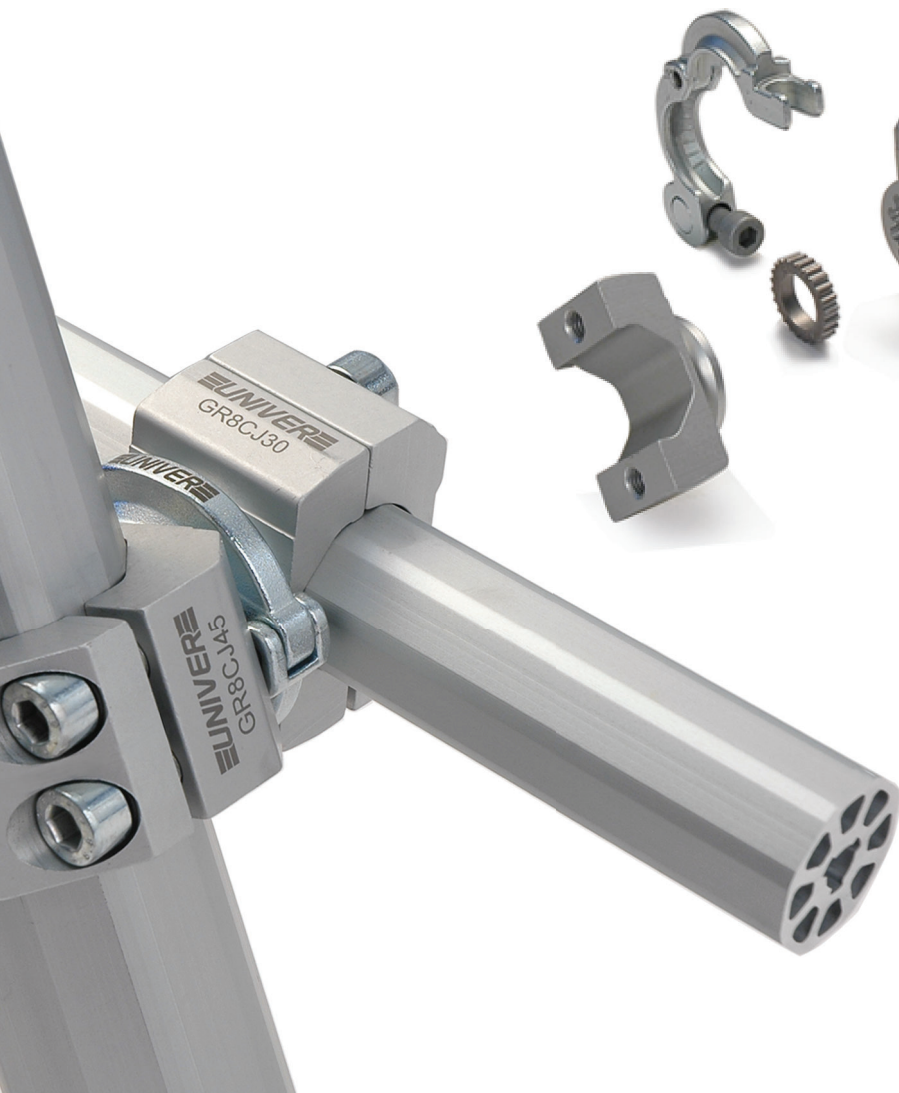
GR8 Tooling



GR8 Tooling

GR8

2



KIT

Considerable reduction of mounting elements

Ø 30 - 45 - 70 mm booms

Maximum stiffness and minimum weight

30

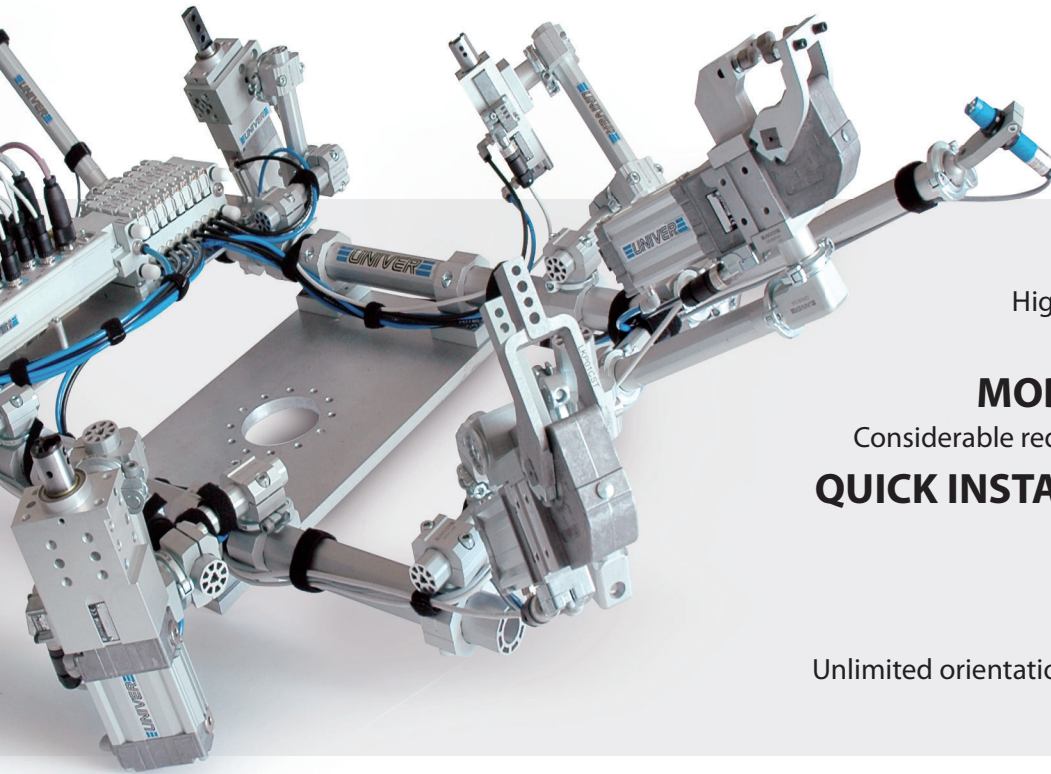


45



70





HIGH PRECISION

High level of positional repeatability;
low deflection

MODULAR COMPONENTS

Considerable reduction of mounting components

QUICK INSTALLATION AND SET UP

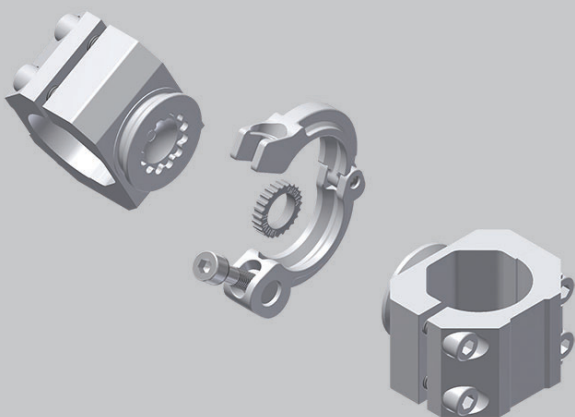
No welding or doweling required,
easily replaceable components

FULLY ADJUSTABLE

Unlimited orientation in space and free configuration

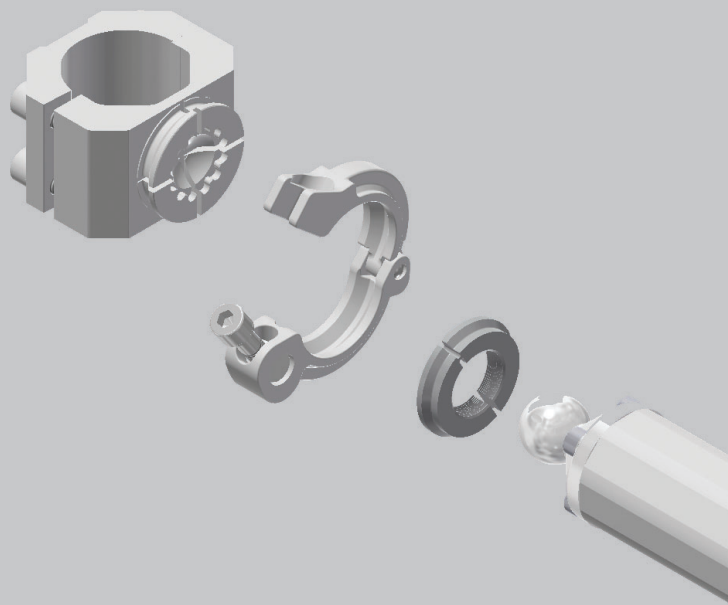
Locking ring

Precise and efficient system to guarantee a high level of positional accuracy



Ball mounting

Unlimited swivel rotation



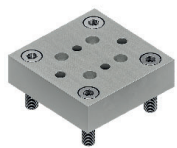
Booms and boom adapters

<p>GR8B30S6000 Octagonal boom Ø30 mm</p>	<p>GR8B456000 Octagonal boom Ø45 mm</p>	<p>GR8B706000 Octagonal boom Ø70 mm</p>	<p>GR8C30 Boom end-cap Ø30 mm</p>	<p>GR8C45 Boom end-cap Ø45 mm</p>
<p>GR8C70 Boom end-cap Ø70 mm</p>	<p>GR8LH Locking ring</p>	<p>GR8LHD Locking ring D</p>	<p>GR8IK Interlocking key insert</p>	<p>GR8SCI30C Interlocking end 30 for ball mounting</p>
<p>GR8SCI30D Interlocking end 30 D</p> <p>200 Nm</p>	<p>GR8ECI45C Interlocking end 45 for ball mounting</p>	<p>GR8ECI45D Interlocking end 45 D</p> <p>200 Nm</p>		








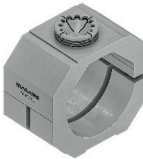









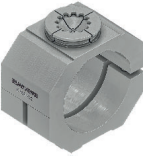



Frame components

<p>GR8BB30 Base plate 30</p>	<p>GR8BB30A Joint 30 without base</p>	<p>GR8BB45 Base plate 45</p>	<p>GR8BB45A Joint 45 without base</p>	<p>GR8BB70 Base plate 70</p>
<p>GR8BB70A Joint 70 without base</p>	<p>GR8HD4530V Joint 45-30</p>	<p>GR8HD4545V Joint 45-45</p>	<p>GR8HD7045 Joint 70-45</p>	<p>GR8HD7070 Joint 70-70</p>
<p>GR8CM4530 Coplanar mount 45-30</p>	<p>GR8CM4545 Coplanar mount 45-45</p>	<p>GR8CM7045 Coplanar mount 70-45</p>	<p>GR8CM7070 Coplanar mount 70-70</p>	<p>GR8BL45 Base linear plate 45</p>


Max static load

<p>GR8BL70 Base linear plate 70</p> 	<p>GR8BB4530B Plate</p> 			
--	--	--	--	--




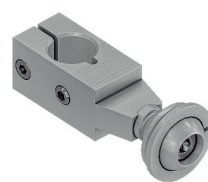


Joint

<p>GR8BC30 Base connector 30</p> 	<p>GR8BC45 Base connector 45</p> 	<p>GR8BC70 Base connector 70</p> 	<p>GR8CJ30C Cross joint 30 for ball mounting</p> 	<p>GR8CJ30D Cross joint 30 D</p>  <p>200 Nm</p>
<p>GR8CJ45C Cross joint 45 for ball mounting</p> 	<p>GR8CJ45D Cross joint 45 D</p>  <p>200 Nm</p>	<p>GR8CJ70C Cross joint 70 for ball mounting</p> 	<p>GR8CJ70D Cross joint 70 D</p>  <p>200 Nm</p>	<p>GR8CJD30C Double cross joint 30 for ball mounting</p> 
<p>GR8CJD30D Double cross joint 30 D</p>  <p>200 Nm</p>	<p>GR8CJD45C Double cross joint 45 for ball mounting</p> 	<p>GR8CJD45D Double cross joint 45 D</p>  <p>200 Nm</p>	<p>GR8RJ30C Round joint 30 for ball mounting</p> 	<p>GR8RJ30D Round joint 30 D</p>  <p>200 Nm</p>
<p>GR8RJ45C Round joint 45 for ball mounting</p> 	<p>GR8RJ45D Round joint 45 D</p>  <p>200 Nm</p>	<p>GR8RJ70C Round joint 70 for ball mounting</p> 	<p>GR8RJ70D Round joint 70 D</p>  <p>200 Nm</p>	<p>GR8R3025 Adapter octagon 30 to round 25</p> 
<p>GR8R4540 Adapter octagon 45 to round 40</p> 				










Angle adapters

<p>GR8A30D Edge mount orientable side for 30 mm boom D</p>  <p>200 Nm</p>	<p>GR8A45D Edge mount orientable side for 45 mm boom D</p>  <p>200 Nm</p>	<p>GR8SM3030 Edge mounting 30-30</p> 	<p>GR8SM4545 Edge mounting 45-45</p> 	
---	---	---	--	--











Ball adapters

<p>GR8MP12 Proximity mount 12 mm</p> 	<p>GR8MP18 Proximity mount 18 mm</p> 	<p>GR8MP30 Proximity mount 30 mm</p> 	<p>GR8MP19 Vacuum cup adapter</p> 	<p>GR8SCB30 Ball mount 30</p> 
<p>GR8SCB45 Ball mount 45</p> 				











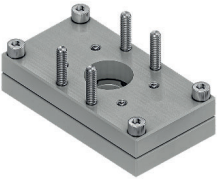
Front mount plates

<p>GR8MF40D Front mount plate D for clamps size 40</p>  <p>200 Nm</p>	<p>GR8RMF4050AD Interlocking adapter for GR8MF40D, GR8MF50D and GR8MFGLD</p> 	<p>GR8MF40PD Mount plate for GR8MF40D</p> 	<p>GR8RMF40C Mount flange angle for GR8MF40D</p> 	<p>GR8MF50D Front mount plate D for clamps size 50/63</p>  <p>200 Nm</p>
<p>GR8MF50PD Mount plate for GR8MF50D</p> 	<p>GR8RMF50C Mount flange angle for GR8MF50D</p> 	<p>GR8MFGLD Front mount plate D for UGP</p> 	<p>GR8MFGLC Counter mount for GR8MFGLD</p> 	

Rear mount plates

<p>GR8SR40 Rear mount plate for clamps size 40</p> 	<p>GR8SR40D Rear mount plate D for clamps size 40</p> 	<p>GR8SR50 Rear mount plate for LCP50</p> 	<p>GR8SR50D Rear mount plate D for LCP50</p> 	<p>GR8SR50M8 Rear mount plate with M8 threads for clamps size 50/63</p> 
<p>GR8SR50M8D Rear mount plate D with M8 threads for clamps size 50/63</p> 	<p>GR8SB4530 Rear mount plate</p> 	<p>GR8SB4530M8 Rear mount plate with M8 threads</p> 	<p>GR8SSLC Flange mount for LCP</p> 	<p>GR8SSLCM8 Flange mount for LCP with M8 threads</p> 

LGPS adapters

<p>LGP32MO25 Orbital mount 360°, ball Ø25 mm for LGPS32</p> 	<p>LGP32MO30 Orbital mount 360°, ball Ø30 mm for LGPS32</p> 	<p>LGP32MP Middle flange mount for LGPS32</p> 	<p>LGP40MO25 Orbital mount 360°, ball Ø25 mm for LGPS40</p> 	<p>LGP40MO30 Orbital mount 360°, ball Ø30 mm for LGPS40</p> 
<p>LGP40MO40 Orbital mount 360°, ball Ø40 mm for LGPS40</p> 	<p>LGP40MO45 Orbital mount 360°, ball Ø45 mm for LGPS40</p> 	<p>LGP40MP Middle flange mount for LGPS40</p> 	<p>LGP32PT070 Rear flange mount 70 mm for LGPS32</p> 	<p>LGP40PT080 Rear flange mount 80 mm for LGPS40</p> 
<p>LGP40PT110 Rear flange mount 110 mm for LGPS40</p> 				

Risers

<p>GR8SK30 Riser size 30</p> 	<p>GR8SK45 Riser size 45</p> 	<p>GR8SK70 Riser size 70</p> 		
---	---	---	--	--

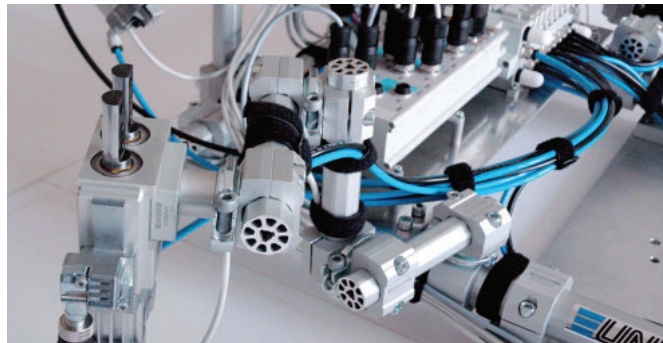
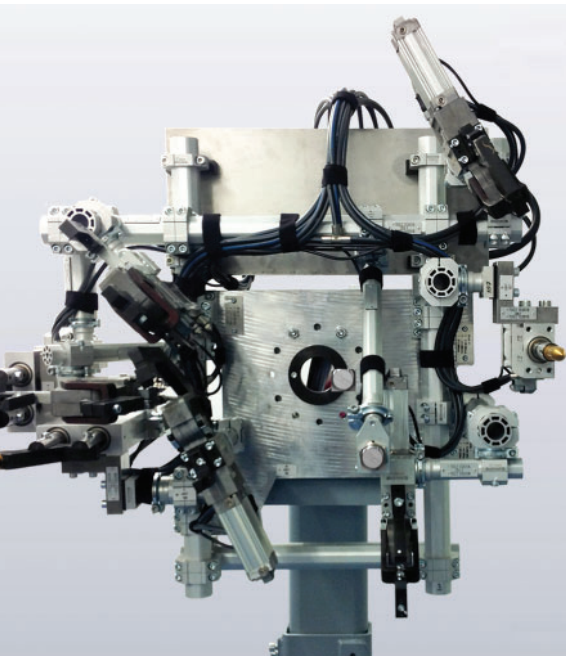
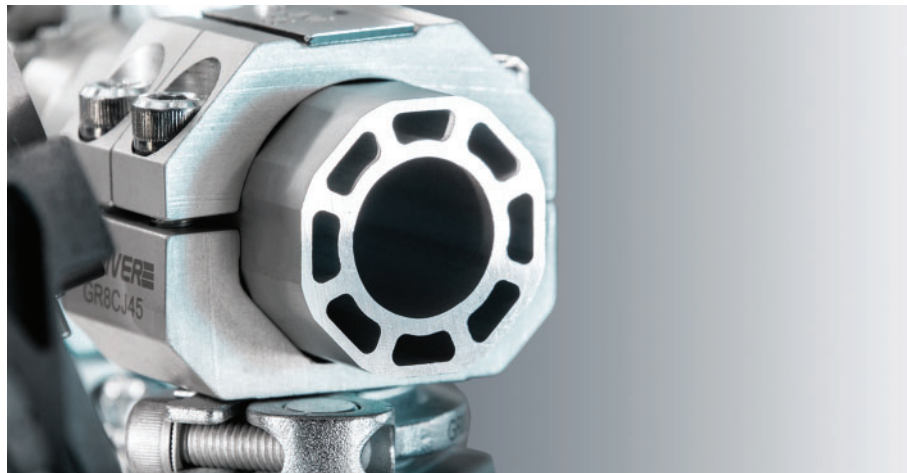
Max static load

200 Nm

Subject to change

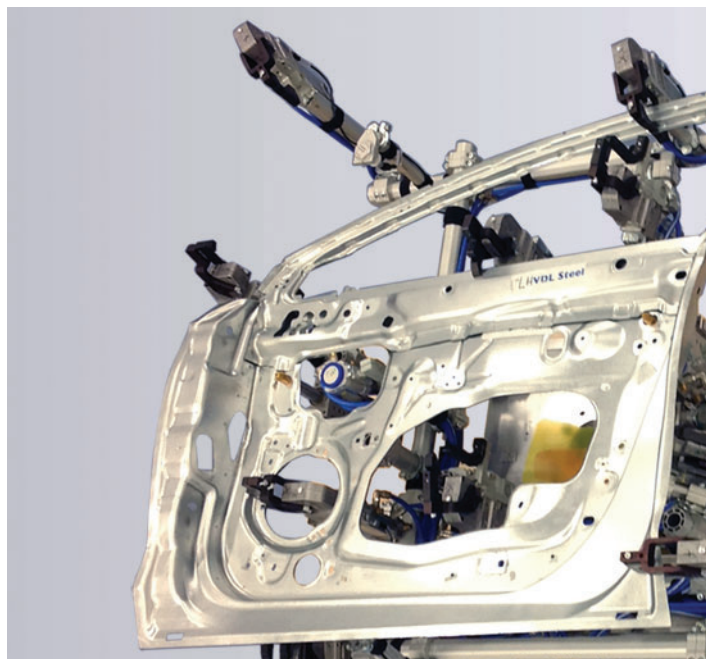
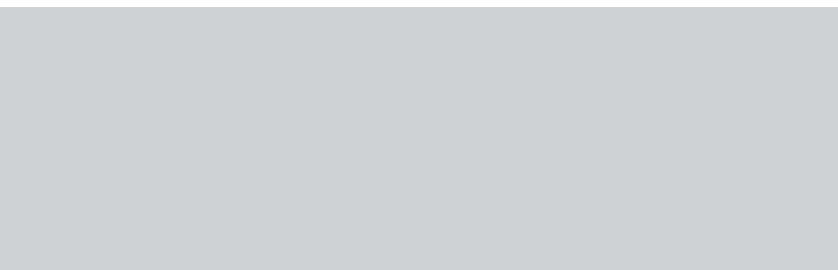
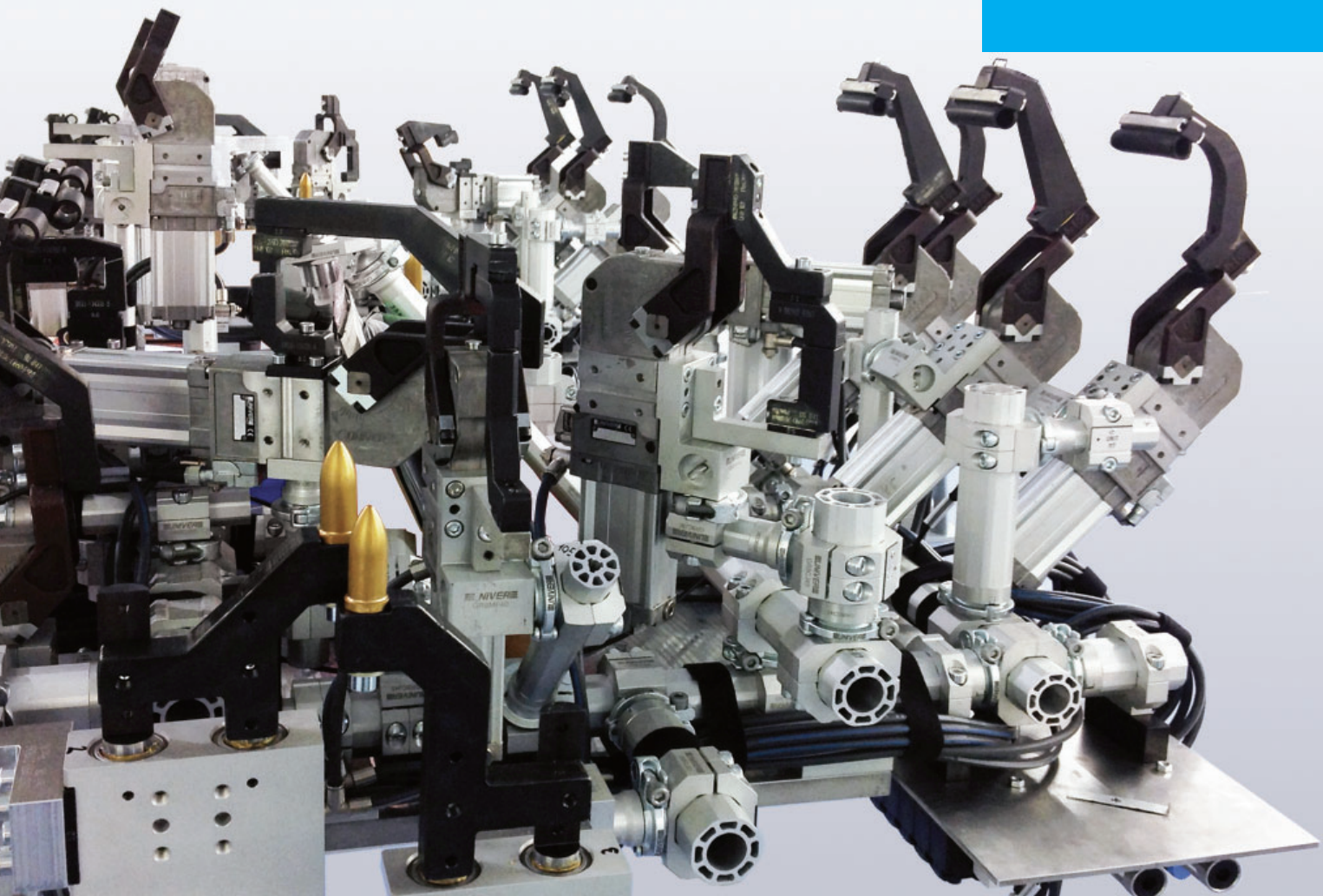
GR8

GR8 application examples



Unlimited and complex configurations
Weight-optimized standard components and brackets
Quick installation and adjustment

COMPLETE SOLUTION
WITH **UNIVER** COMPONENTS



Compliance with
International Standards

DIRECTIVE 2014/34 UE "ATEX"	Directive that specifies the safety requirements for equipment/components for use in potentially explosive atmospheres
DIRECTIVE 2011/65/EU "ROHS" DIRECTIVE 2012/19/EU "WEEE"	Directive which regulates the use and disposal of hazardous substances in electrical and electronic equipment.
DIRECTIVE "REACH"	CE 1907/2006 of the European Parliament and the Council concerning the Registration, Evaluation, Authorisation and Restriction of chemicals substance
DIRECTIVE 97/23/CE "PED"	Directive applies to the design, manufacture and conformity assessment of pressure equipment and assemblies with a maximum allowable pressure greater than 0.5 bar.
DIRECTIVE 2006/42/CE "MACHINERY"	Directive defining essential health and safety requirements for the design, construction, installation and maintenance of machinery.
PRODUCT CERTIFICATION "CSA/UL"	Nr. 24 48884 Nr. LR 113373-1 Product Safety certification for the North American market (Unite States – Canada)
ISO 9001:2015 "QUALITY MANAGEMENT SYSTEM"	Standard specifying Quality Management System requirements.



For further information contact our Sales Office or visit our website www.univer-group.com

PART NO.	PAGE	PART NO.	PAGE	PART NO.	PAGE	PART NO.	PAGE	PART NO.	PAGE
A-101N	3.8	AC-7013	3.48	AG-3001	3.54	AI-3511Q	3.90	AI-9100	3.57
A-102N	3.8	AC-7013P	3.48	AG-3002	3.54	AI-3512	3.90	AI-9100M	3.57
A-111N	3.8	AC-7100	3.48	AG-3009	3.54	AI-3512Q	3.90	AI-9110	3.57
A-112N	3.8	AC-7120	3.48	AG-3010	3.54	AI-3513	3.90	AI-9110M	3.57
A-121N	3.8	AC-7500	3.49	AG-3011	3.54	AI-3513Q	3.90	AI-9120	3.57
A-122N	3.8	AC-7520	3.49	AG-3012	3.54	AI-3514	3.90	AI-9120M	3.57
A-131N	3.8	AC-7900	3.49	AG-3020	3.54	AI-3514D	3.90	AI-9200	3.57
A-141N	3.8	AC-7905	3.49	AG-3021	3.54	AI-3514Q	3.90	AI-9200M	3.57
A-142N	3.8	AC-8010	3.48	AG-3040	3.54	AI-3514QD	3.90	AI-9210	3.57
A-151N	3.8	AC-8013	3.48	AG-3041	3.54	AI-3515	3.90	AI-9210M	3.57
A-161N	3.8	AC-8013P	3.48	AG-3050	3.54	AI-3515Q	3.90	AI-9220	3.57
A-162N	3.8	AC-8100	3.48	AG-3051	3.54	AI-3516	3.90	AI-9220M	3.57
A-171N	3.8	AC-8120	3.48	AG-3062	3.54	AI-3516D	3.90	AI-9300	3.58
A-299-11	3.8	AC-8500	3.49	AG-3063	3.54	AI-3516Q	3.90	AI-9300M	3.58
A-301	3.8	AC-8520	3.49	AG-3071	3.54	AI-3516QD	3.90	AI-9310	3.58
A-305	3.8	AC-8900	3.49	AG-3072	3.54	AI-3517	3.90	AI-9310M	3.58
A-326A/B/D	3.8	AC-9010	3.48	AG-3073	3.54	AI-3517Q	3.90	AI-9320	3.58
A-345	3.8	AC-9013	3.48	AG-3074	3.54	AI-3519	3.90	AI-9320M	3.58
A-350	3.8	AC-9013P	3.48	AG-3075	3.54	AI-3519Q	3.90	AI-9350	3.58
AA-0150	3.9	AC-9100	3.48	AG-3076	3.54	AI-3520	3.91	AI-9350M	3.58
AA-0157	3.9	AC-9120	3.48	AG-3081	3.55	AI-3520Q	3.91	AI-9360	3.58
AA-0170	3.9	AC-9500	3.49	AG-3082	3.55	AI-3521	3.91	AI-9360M	3.58
AA-0184	3.9	AC-9520	3.49	AG-3091	3.55	AI-3521Q	3.91	AI-9370	3.58
AA-0186	3.9	AC-N8100	3.22	AG-3092	3.55	AI-3522	3.91	AI-9370M	3.58
AA-0188	3.9	AC-N8120	3.22	AG-3100	3.55	AI-3522Q	3.91	AI-9400	3.58
AA-0211	3.9	AC-N8500	3.22	AG-3101	3.55	AI-3523	3.91	AI-9400M	3.58
AA-0213	3.9	AC-N8520	3.22	AG-3110	3.55	AI-3523Q	3.91	AI-9410	3.58
AA-0219	3.9	AE-1000	3.15	AG-3111	3.55	AI-3524	3.90	AI-9410M	3.58
AA-0231	3.9	AE-1003	3.15	AG-3210	3.55	AI-3524Q	3.90	AI-9420	3.58
AA-0233	3.9	AE-1009	3.15	AG-3211	3.55	AI-3525	3.91	AI-9420M	3.58
AA-0239	3.9	AE-1010	3.15	AG-3214	3.55	AI-3525Q	3.91	AI-9500B	3.59
AA-0400	3.9	AE-1100	3.15	AG-3215	3.55	AI-3526	3.91	AI-9500BM	3.59
AA-0400U	3.9	AE-1103	3.15	AG-3222	3.55	AI-3526Q	3.91	AI-9510B	3.59
AA-0402	3.9	AE-1120	3.15	AG-3223	3.55	AI-3529	3.91	AI-9510BM	3.59
AA-0404	3.9	AE-1121	3.15	AG-3232	3.55	AI-3550	3.91	AI-9520B	3.59
AA-0450	3.9	AF-2500	3.52	AG-3233	3.55	AI-3551	3.91	AI-9520BM	3.59
AB-0600	3.10	AF-2501	3.52	AG-3242	3.55	AI-3560	3.91	AI-9550B	3.59
AB-0613	3.10	AF-2510	3.52	AG-3243	3.55	AI-3562	3.91	AI-9550BM	3.59
AB-0640	3.10	AF-2511	3.52	AG-3256	3.55	AI-3563	3.91	AI-9560B	3.59
AB-0643	3.10	AF-2517	3.52	AG-3257	3.55	AI-3570	3.91	AI-9560BM	3.59
AB-0681	3.10	AF-2518	3.52	AG-3300	3.55	AI-3571	3.91	AI-9570B	3.59
AB-0685	3.10	AF-2520	3.52	AG-3301	3.55	AI-3572	3.91	AI-9570BM	3.59
AB-0687	3.10	AF-2521	3.52	AG-3302	3.55	AI-35B10N	3.59	AM41000060	5.21
AB-0722	3.10	AF-2524	3.52	AG-3303	3.55	AI-35B10R	3.59	AM41000080	5.21
AB-0728	3.10	AF-2525	3.52	AG-3310	3.55	AI-35B10V	3.59	AM41000120	5.21
AB-0751	3.10	AF-2530	3.52	AG-3311	3.55	AI-35B11N	3.59	AM41000160	5.21
AB-0755	3.10	AF-2531	3.52	AG-3312	3.55	AI-35B11R	3.59	AM41000200	5.21
AB-0757	3.10	AF-2540	3.52	AG-3313	3.55	AI-35B11V	3.59	AM41000240	5.21
AB-0765	3.10	AF-2541	3.52	AG-3320	3.55	AI-35B13N	3.59	AM41000280	5.21
AB-0771	3.10	AF-2545	3.52	AG-3321	3.55	AI-35B13R	3.59	AM41000320	5.21
AB-0819	3.10	AF-2546	3.52	AG-3322	3.55	AI-35B20	3.59	AM41000360	5.21
AB-0822	3.10	AF-2550	3.53	AG-3330	3.55	AI-35B21	3.59	AM41000400	5.21
AB-0824	3.10	AF-2551	3.53	AG-3331	3.55	AI-35B22	3.59	AM41000440	5.21
AB-0825	3.10	AF-2552	3.53	AG-3332	3.55	AI-35B25	3.59	AM-5000	3.60
AB-0826	3.10	AF-2561	3.52	AI-3500	3.56	AI-35B26	3.59	AM-5000A	3.60
AB-0827	3.10	AF-2565	3.52	AI-3500Q	3.56	AI-35B27	3.59	AM-5001	3.60
AB-0828	3.10	AF-2600	3.52	AI-3500S	3.56	AI-35B30	3.59	AM-5001A	3.60
AB-0829	3.10	AF-2601	3.52	AI-3500SQ	3.56	AI-35B31	3.59	AM-5002	3.60
AB-0830	3.10	AF-2603	3.53	AI-3501	3.56	AI-35B32	3.59	AM-5003	3.60
AB-0831	3.10	AF-2606	3.52	AI-3501Q	3.56	AI-3610	3.56	AM-5003A	3.60
AB-0832	3.10	AF-2610	3.53	AI-3501S	3.56	AI-3612	3.56	AM-5004	3.60
AB-0833	3.10	AF-2615	3.53	AI-3501SQ	3.56	AI-9000	3.57	AM-5004A	3.60
AB-0885	3.10	AF-2617	3.53	AI-3502	3.56	AI-9000M	3.57	AM-5005	3.60
AB-0886	3.10	AF-2620	3.53	AI-3502Q	3.56	AI-9010	3.57	AM-5011	3.60
AB-0888	3.10	AF-2700	3.52	AI-3503	3.56	AI-9010M	3.57	AM-5012	3.60
AB-0900	3.9/10	AF-2701	3.52	AI-3503Q	3.56	AI-9020	3.57	AM-5015	3.60
AC-7010	3.48	AF-2706	3.52	AI-3511	3.90	AI-9020M	3.57	AM-5021	3.60

PART NO.	PAGE	PART NO.	PAGE	PART NO.	PAGE	PART NO.	PAGE	PART NO.	PAGE
AM-5031	3.60	AM-5500	3.97	BDB-384424	3.18	BDF-4232	3.21	BE-4940	3.12
AM-5041	3.60	AM-5501	3.97	BDB-424024	3.18	BDF-4310	3.20	BE-5000	3.12
AM-5043	3.60	AM-5502	3.97	BDB-424124	3.18	BDF-4311	3.21	BE-5020	3.12
AM-5043B	3.60	AM-5503	3.97	BDB-424424	3.18	BDF-4312	3.21	BE-5030	3.12
AM-5043C	3.60	AM-5504	3.97	BDB-434424	3.18	BDF-4320	3.20	BE-5060	3.12
AM-5043D	3.60	AM-5510	3.97	BDB-444424	3.18	BDF-4321	3.21	BE-5100	3.12
AM-5050	3.60	AM-5511	3.97	BDB-454424	3.18	BDF-4322	3.21	BE-5150	3.12
AM-5051	3.60	AM-5512	3.97	BDB-464424	3.18	BDF-4330	3.20	BE-5170	3.12
AM-5052	3.60	AM-5513	3.97	BDB-474424	3.18	BDF-4331	3.21	BE-5200	3.12
AM-5060	3.96	AM-5514	3.97	BDB-484424	3.18	BDF-4332	3.21	BE-5205	3.12
AM-5061	3.96	AP-500	3.96	BDE-324024	3.18	BDF-4400	3.20/21	BE-5700	3.12
AM-5062	3.96	AP-520	3.96	BDE-324124	3.18	BE12-3000	3.13	BE-5720	3.12
AM-5063	3.96	AZ4-SN003A	3.63	BDE-324424	3.18	BE12-3020	3.13	BE-5730	3.12
AM-5064	3.96	AZ4-SN004A	3.36	BDE-334424	3.18	BE12-3205	3.13	BE-5760	3.12
AM-5065	3.96	AZ4-VN0310	3.63	BDE-344424	3.18	BE12-3700	3.13	BE-5800	3.12
AM-5066	3.96	AZ4-VN0414	3.70	BDE-354424	3.18	BE12-3720	3.13	BE-5850	3.12
AM-5067	3.96	AZ4-VN0416	3.36	BDE-364424	3.18	BE12-3900	3.13	BE-5870	3.12
AM-5070	3.96	B10	3.4	BDE-374424	3.18	BE12-3940	3.13	BE-5900	3.12
AM-5071	3.96	B-101N	3.7	BDE-384424	3.18	BE12-4000	3.13	BE-5940	3.12
AM-5072	3.96	B-102N	3.7	BDE-424024	3.18	BE12-4020	3.13	BE-6000	3.12
AM-5074	3.96	B11	3.3	BDE-424124	3.18	BE12-4205	3.13	BE-6020	3.12
AM-5076	3.96	B12	3.5	BDE-424424	3.18	BE12-4700	3.13	BE-6030	3.12
AM-5077	3.96	B-121N	3.7	BDE-434424	3.18	BE12-4720	3.13	BE-6060	3.12
AM-5090	3.96	BDA-3230	3.19	BDE-444424	3.18	BE12-4900	3.13	BE-6100	3.12
AM-5091	3.96	BDA-3231	3.19	BDE-454424	3.18	BE12-4940	3.13	BE-6150	3.12
AM-5092	3.96	BDA-3233	3.19	BDE-464424	3.18	BE12-5000	3.13	BE-6170	3.12
AM-5109	3.89	BDA-3240	3.19	BDE-474424	3.18	BE12-5020	3.13	BE-6200	3.12
AM-5110	3.89	BDA-3241	3.19	BDE-484424	3.18	BE12-5205	3.13	BE-6205	3.12
AM-5111	3.89	BDA-3244	3.19	BDF-3100	3.20	BE12-5700	3.13	BE-6700	3.12
AM-5148	3.29	BDA-3333	3.19	BDF-3110	3.21	BE12-5720	3.13	BE-6720	3.12
AM-5151	3.29	BDA-3344	3.19	BDF-3115	3.20/21	BE12-5900	3.13	BE-6730	3.12
AM-5152	3.29	BDA-3433	3.19	BDF-3120	3.20	BE12-5940	3.13	BE-6760	3.12
AM-5160	3.96	BDA-3444	3.19	BDF-3125	3.21	BE-3000	3.12	BE-6800	3.12
AM-5161	3.96	BDA-3533	3.19	BDF-3140TIM	3.20	BE-3020	3.12	BE-6850	3.12
AM-5162	3.96	BDA-3544	3.19	BDF-3180	3.20/21	BE-3030	3.12	BE-6870	3.12
AM-5163	3.96	BDA-3633	3.19	BDF-3185	3.20/21	BE-3060	3.12	BE-6900	3.12
AM-5164	3.96	BDA-3644	3.19	BDF-3190	3.20	BE-3100	3.12	BE-6940	3.12
AM-5200	3.97	BDA-3733	3.19	BDF-3191	3.21	BE-3150	3.12	BF-1060	3.13
AM-5211A	3.9	BDA-3744	3.19	BDF-3210	3.20	BE-3170	3.12	BF-1061	3.13
AM-5211B	3.9	BDA-3833	3.19	BDF-3211	3.21	BE-3200	3.12	BF-1062	3.13
AM-5212A	3.10	BDA-3844	3.19	BDF-3212	3.21	BE-3205	3.12	BF-1063	3.13
AM-5212B	3.10	BDA-4230	3.19	BDF-3230	3.20	BE-3700	3.12	BF-1065	3.14
AM-5213A	3.9	BDA-4231	3.19	BDF-3231	3.21	BE-3720	3.12	BF-1066	3.14
AM-5214A	3.10	BDA-4233	3.19	BDF-3232	3.21	BE-3730	3.12	BF-1068	3.14
AM-5220	3.97	BDA-4240	3.19	BDF-3310	3.20	BE-3760	3.12	BF-1070	3.14
AM-5240	3.97	BDA-4241	3.19	BDF-3311	3.21	BE-3800	3.12	BF-1071	3.13
AM-5241	3.97	BDA-4244	3.19	BDF-3312	3.21	BE-3850	3.12	BF-1071S	3.13
AM-5242	3.97	BDA-4333	3.19	BDF-3330	3.20	BE-3870	3.12	BF-1072	3.13
AM-5242E	3.97	BDA-4344	3.19	BDF-3331	3.21	BE-3900	3.12	BF-1072S	3.13
AM-5243	3.97	BDA-4433	3.19	BDF-3332	3.21	BE-3940	3.12	BF-1085	3.14
AM-5243E	3.97	BDA-4444	3.19	BDF-3400	3.20	BE-4000	3.12	BF-1150	3.13
AM-5254	3.97	BDA-4533	3.19	BDF-4100	3.20	BE-4020	3.12	BF-1151	3.13
AM-5255	3.97	BDA-4544	3.19	BDF-4110	3.21	BE-4030	3.12	BF-1152	3.13
AM-5256	3.97	BDA-4633	3.19	BDF-4115	3.20/21	BE-4060	3.12	BF-1153	3.13
AM-5259	3.97	BDA-4644	3.19	BDF-4120	3.20	BE-4100	3.12	BF-1154	3.14
AM-5260	3.97	BDA-4733	3.19	BDF-4125	3.21	BE-4150	3.12	BF-1155	3.14
AM-5261	3.97	BDA-4744	3.19	BDF-4140 TIM	3.20	BE-4170	3.12	BF-1160	3.13
AM-5350	3.97	BDA-4833	3.19	BDF-4180	3.20/21	BE-4200	3.12	BF-1161	3.13
AM-5351	3.97	BDA-4844	3.19	BDF-4185	3.20/21	BE-4205	3.12	BF-1162	3.14
AM-5352	3.97	BDB-324024	3.18	BDF-4210	3.20	BE-4700	3.12	BF-1175	3.14
AM-5353	3.97	BDB-324124	3.18	BDF-4211	3.21	BE-4720	3.12	BF-1190	3.14
AM-5354	3.97	BDB-324424	3.18	BDF-4212	3.21	BE-4730	3.12	BF-3060	3.13
AM-5355	3.97	BDB-334424	3.18	BDF-4220	3.20	BE-4760	3.12	BF-3061	3.13
AM-5356	3.97	BDB-344424	3.18	BDF-4221	3.21	BE-4800	3.12	BF-3064	3.14
AM-5400	3.97	BDB-354424	3.18	BDF-4222	3.21	BE-4850	3.12	BF-3071	3.13
AM-5401	3.97	BDB-364424	3.18	BDF-4230	3.20	BE-4870	3.12	BF-3072	3.13
AM-5402	3.97	BDB-374424	3.18	BDF-4231	3.21	BE-4900	3.12	BF-3082	3.14

PART NO.	PAGE	PART NO.	PAGE	PART NO.	PAGE	PART NO.	PAGE	PART NO.	PAGE
BF-3175	3.14	CL-320	3.28	CM-423E	3.26	CM-9622	3.28	DB-U509	3.92
BF-3190	3.14	CL-321	3.28	CM-423F	3.26	CM-9680	3.28	DB-U510	3.92
BF-3191	3.14	CL-322	3.28	CM-424E	3.26	CM-9685	3.28	DC-0301	3.89
BF-4060	3.13	CL-9102A	3.24	CM-424F	3.26	CM-9690	3.28	DC-0302	3.89
BF-4061	3.13	CL-9102P	3.24	CM-425E	3.26	CP-100	3.29	DC-0307	3.89
BF-4062	3.13	CL-9103A	3.24	CM-425F	3.26	CP-101	3.29	DC-0309	3.89
BF-4063	3.13	CL-9103P	3.24	CM-426A	3.26	CP-105	3.29	DC-0310	3.89
CH-250	3.50	CL-9110A	3.25	CM-430	3.26	CP-106	3.29	DC-U301	3.92
CH-252	3.50	CL-9110P	3.25	CM-430E	3.26	CP-110	3.29	DC-U302	3.92
CH-254	3.50	CL-9111A	3.25	CM-435E	3.26	CP-111	3.29	DC-U304	3.92
CH-256	3.50	CL-9111P	3.25	CM-440E	3.26	CP-112	3.29	DC-U307	3.92
CH-260	3.50	CL-9113A	3.25	CM-500	3.28	CP-113	3.29	DC-U309	3.92
CH-262	3.50	CL-9113P	3.25	CM-500A	3.28	CP-9100	3.29	DC-U310	3.92
CH-264	3.50	CL-9118R	3.27	CM-520	3.28	CP-9101	3.29	DD-013	3.89
CH-266	3.50	CL-9120	3.27	CM-521	3.28	CP-9105	3.29	DD-040	3.89
CH-270	3.50	CL-9120A	3.27	CM-524	3.28	CP-9110	3.29	DD-040-2C	3.36
CH-272	3.50	CL-9120P	3.27	CM-580	3.28	CP-9111	3.29	DD-041	3.89
CH-274	3.50	CL-9121R	3.27	CM-585	3.28	CP-9112	3.29	DD-042	3.89
CH-276	3.50	CL-9123	3.27	CM-590	3.28	CP-9113	3.29	DD-050	3.89
CH-280	3.50	CL-9123A	3.27	CM-600	3.28	CP-911G	3.26/27	DD-051	3.89
CH-282	3.50	CL-9123D	3.27	CM-602A	3.28	CP-911N	3.26/27	DD-051-2C	3.36
CH-284	3.50	CL-9130	3.27	CM-620	3.28	CP-911R	3.26/27	DD-051L030	3.89
CH-286	3.50	CL-9200	3.28	CM-621	3.28	CP-911V	3.26/27	DD-052	3.89
CL-100A	3.24	CL-9200A	3.28	CM-622	3.28	CP-912G	3.26	DD-052L030	3.89
CL-100P	3.24	CL-9203	3.28	CM-680	3.28	CP-912N	3.26	DD-060	3.89
CL-101A	3.24	CL-9220	3.28	CM-685	3.28	CP-912R	3.26	DD-070	3.89
CL-101P	3.24	CL-9221	3.28	CM-690	3.28	CP-913R	3.26/27	DD-151	3.89
CL-102A	3.24	CL-9224	3.28	CM-9402A	3.24	CP-915R	3.26/27	DD-351	3.89
CL-102P	3.24	CL-9300	3.28	CM-9402P	3.24	CP-916R	3.26/27	DD-551	3.89
CL-103A	3.24	CL-9301	3.28	CM-9403A	3.24	D-500	3.89	DE-052L030	3.88
CL-103P	3.24	CL-9302A	3.28	CM-9403P	3.24	D-530-200	3.89	DE-352	3.88
CL-104A	3.24	CL-9303A	3.28	CM-9410A	3.25	D-530-30	3.89	DE-355	3.88
CL-104P	3.24	CL-9320	3.28	CM-9410P	3.25	D-530-50	3.89	DE-452	3.88
CL-105A	3.24	CL-9321	3.28	CM-9411A	3.25	D-530C-100	3.88	DE-552	3.88
CL-105P	3.24	CL-9322	3.28	CM-9411P	3.25	D-530C-200	3.88	DE-642I	3.88
CL-106A	3.24	CM-400A	3.24	CM-9413A	3.25	D-535-200	3.89	DE-652	3.88
CL-106AL	3.24	CM-400P	3.24	CM-9413P	3.25	D-535-30	3.89	DE-652I	3.88
CL-110A	3.25	CM-401A	3.24	CM-9418R	3.27	D-535-50	3.89	DF-001	5.28
CL-110P	3.25	CM-401P	3.24	CM-9420	3.27	D-535U40300	3.3	DF-003	1.28
CL-111A	3.25	CM-402A	3.24	CM-9420A	3.27	D-535U40500	3.3	DF-004	1.28
CL-111P	3.25	CM-402P	3.24	CM-9420P	3.27	DA-0050	3.89	DF-220	5.28
CL-112A	3.25	CM-403A	3.24	CM-9421R	3.27	DA-0051	3.89	DF-220L10	5.28
CL-112P	3.25	CM-403P	3.24	CM-9423	3.27	DA-0106	3.89	DF-220L5	5.28
CL-113A	3.25	CM-404A	3.24	CM-9423A	3.27	DA-0108	3.89	DF-220M08	5.28
CL-113P	3.25	CM-404P	3.24	CM-9423D	3.27	DA-0124	3.89	DF-220M12	5.28
CL-118R	3.26	CM-405A	3.24	CM-9423E	3.27	DA-U050	3.92	DF-330	5.28
CL-119R	3.26	CM-405P	3.24	CM-9423F	3.27	DA-U051	3.92	DF-330L10	5.28
CL-120	3.26	CM-406A	3.24	CM-9424E	3.27	DA-U101	3.92	DF-330L5	5.28
CL-120A	3.26	CM-406AL	3.24	CM-9424F	3.27	DA-U102	3.92	DF-330M08	5.28
CL-120P	3.26	CM-410A	3.25	CM-9425E	3.27	DA-U103	3.92	DF-330M12	5.28
CL-121R	3.26	CM-410P	3.25	CM-9425F	3.27	DA-U104	3.92	DF-440	5.28
CL-122R	3.26	CM-411A	3.25	CM-9430	3.27	DA-U106	3.92	DF-440M08	5.28
CL-123	3.26	CM-411P	3.25	CM-9430E	3.27	DA-U108	3.92	DF-440M12	5.28
CL-123A	3.26	CM-412A	3.25	CM-9435E	3.27	DA-U124	3.92	DF-770	5.28
CL-123D	3.26	CM-412P	3.25	CM-9440E	3.27	DB-0501	3.89	DF-770M08	5.28
CL-126A	3.26	CM-413A	3.25	CM-9500	3.28	DB-0502	3.89	DF-770M12	5.28
CL-130	3.26	CM-413P	3.25	CM-9500A	3.28	DB-0507	3.89	DF-K	6.10
CL-200	3.28	CM-418R	3.26	CM-9520	3.28	DB-0509	3.89	DF-MA	5.33
CL-200A	3.28	CM-419R	3.26	CM-9521	3.28	DB-0510	3.89	DF-MAF12T	5.33
CL-203	3.28	CM-420	3.26	CM-9524	3.28	DB-0607	3.55	DF-MAF12TR	5.33
CL-220	3.28	CM-420A	3.26	CM-9580	3.28	DB-0608	3.55	DF-MS	5.32
CL-221	3.28	CM-420P	3.26	CM-9585	3.28	DB-0610	3.55	DF-P700L06	1.19
CL-224	3.28	CM-421R	3.26	CM-9590	3.28	DB-U501	3.92	DF-R002	5.30
CL-300	3.28	CM-422R	3.26	CM-9600	3.28	DB-U502	3.92	DF-R003	5.30
CL-301	3.28	CM-423	3.26	CM-9602A	3.28	DB-U503	3.92	DF-RW700L03	5.31
CL-302A	3.28	CM-423A	3.26	CM-9620	3.28	DB-U504	3.92	DF-RW700M12	5.31
CL-303A	3.28	CM-423D	3.26	CM-9621	3.28	DB-U507	3.92	DF-S	6.10

PART NO.	PAGE	PART NO.	PAGE	PART NO.	PAGE	PART NO.	PAGE	PART NO.	PAGE
DF-T200L03	5.30	E-0420	3.31	EL22F533	3.83	G-6655	3.35	GL-6844	3.38
DF-T200M08	5.30	E-0422	3.31	EL22F555	3.84	G-6666	3.35	GL-6855	3.38
DF-T700L03	5.30	E-0440	3.31	EL22F633	3.83	G-6733	3.34	GL-6866	3.38
DF-T700M08	5.30	E-0444	3.31	EL22F655	3.84	G-6744	3.35	GP-6100	3.36/39
DH-200	5.29	E-0470	3.31	EL22F733	3.83	G-6755	3.35	GP-6110	3.36/39
DH-200L05	5.29	E-0477	3.31	EL22F755	3.84	G-6766	3.35	GP-611212	3.36/39
DH-200L10	5.29	E-0522	3.30	EL22F833	3.83	G-6833	3.34	GP-611806	3.36/39
DH-200M08	5.29	E-0622	3.30	EL22F855	3.84	G-6844	3.35	GP-6210	3.39
DH-200M12	5.29	E-0722	3.30	EL22SF300	3.84	G-6855	3.35	GP-6211	3.39
DH-500	5.29	E-0822	3.31	EL22SF515	3.84	G-6866	3.35	GP-6212	3.39
DH-500L10	5.29	E-0922	3.31	EL22SF516	3.84	G-7230	3.41	GP-6220	3.39
DH-500L5	5.29	E-1022	3.31	EL22SF518	3.84	G-7231	3.41	GP-6221	3.39
DH-500M08	5.29	E-15402A	3.32	EL22SF550	3.84	G-7233	3.41	GP-6222	3.39
DH-500M12	5.29	E-15403A	3.32	EL22SF560	3.84	G-7290	3.41	GP-6230	3.39
DH-700	5.29	E-15412A	3.32	EL22SF570	3.84	G-7291	3.41	GP-6231	3.39
DH-700L10	5.29	E-15420	3.32	EL22SF900-02	3.85	G-7299	3.41	GP-6232	3.39
DH-700L5	5.29	E-15420A	3.32	EL22SF900-03	3.85	G-7333	3.41	GP-6240	3.39
DH-700M08	5.29	E-15422G	3.32	EL22SF900-04	3.85	G-7399	3.41	GP-6241	3.39
DH-700M12	5.29	E-15422N	3.32	EL22SF900-05	3.85	G-7433	3.41	GP-6242	3.39
DHF-0020100	5.28	E-15422R	3.32	EL22SF900-06	3.85	G-7499	3.41	GP-6285	3.39
DHF-033M08	5.28	E-4500	3.31	EL22SF900-07	3.85	G-7533	3.41	GP-6310	3.36
DHF-033M12	5.28	E-4505	3.31	EL22SF900-08	3.85	G-7599	3.41	GP-6311	3.36
DHF-053M08	5.28	E-4600	3.31	EL22SF900-09	3.85	G-7885	3.41	GP-6312	3.36
DHF-053M12	5.28	EL18F230	3.80	EL22SF900-10	3.85	G-7900-02	3.41	GP-6320	3.36
DHF-P24M08	5.32	EL18F231	3.80	F-0220	3.33	G-7900-03	3.41	GP-6321	3.36
DHF-P24M0890	5.32	EL18F233	3.80	F-0222	3.33	G-7900-04	3.41	GP-6322	3.36
DHF-P54M08	5.32	EL18F250	3.81	F-0240	3.33	G-7900-05	3.41	GP-6330	3.36
DHF-P54M0890	5.32	EL18F251	3.81	F-0244	3.33	G-7900-06	3.41	GP-6331	3.36
DH-K032050	5.29	EL18F255	3.81	F-0270	3.33	G-7900-07	3.41	GP-6332	3.36
DH-K063125	5.29	EL18F333	3.80	F-0277	3.33	G-7900-08	3.41	GP-6340	3.36
DH-K160200	5.29	EL18F355	3.81	F-0522	3.33	G-7900-09	3.41	GP-6341	3.36
DH-K250	5.29	EL18F433	3.80	F-0544	3.33	G-7900-10	3.41	GP-6342	3.36
DH-K320DF	5.28	EL18F455	3.81	F-0577	3.33	G-7900-11	3.41	GP-6380	3.36/39
DH-M10	5.29	EL18F533	3.80	F-0622	3.33	G-7900-12	3.41	GP-6385	3.36
DH-M10DF	5.28	EL18F555	3.81	F-0644	3.33	GL-6230	3.37	GP-6400-1	3.36/39
DH-M12	5.29	EL18F633	3.80	F-0677	3.33	GL-6231	3.37	GP-6400-2	3.36/39
DH-M12DF	5.28	EL18F655	3.81	F-0722	3.33	GL-6233	3.37	GP-6400-5	3.36/39
DH-M16	5.29	EL18F733	3.80	F-0744	3.33	GL-6240	3.38	GP-6411	3.39
DH-M16DF	5.28	EL18F755	3.81	F-0777	3.33	GL-6241	3.38	GP-6512-01MF	3.36/39
DH-M20	5.29	EL18F833	3.80	F-4500	3.33	GL-6244	3.38	GP-6512-02MF	3.36/39
DH-M20DF	5.28	EL18F855	3.81	F-4505	3.33	GL-6250	3.38	GP-6512-03MF	3.36/39
DH-M25	5.29	EL18SF300	3.81	G-6230	3.34	GL-6251	3.38	GP-6512-05MF	3.36/39
DH-M25DF	5.28	EL18SF515	3.81	G-6231	3.34	GL-6255	3.38	GP-6512-06MF	3.36/39
DH-P016020DFI	1.19	EL18SF516	3.81	G-6233	3.34	GL-6260	3.38	GP-6514-01MF	3.36/39
DH-P020DFI	1.22	EL18SF518	3.81	G-6240	3.35	GL-6261	3.38	GP-6514-02MF	3.36/39
DH-P025032DFI	1.19	EL18SF550	3.81	G-6241	3.35	GL-6266	3.38	GP-6514-03MF	3.36/39
DH-P040DFI	1.21	EL18SF560	3.81	G-6244	3.35	GL-6333	3.37	GP-6514-05MF	3.36/39
DH-P050DFI	1.21	EL18SF570	3.81	G-6250	3.35	GL-6344	3.38	GP-6514-06MF	3.36/39
DH-P063DFI	1.21	EL18SF900-02	3.82	G-6251	3.35	GL-6355	3.38	GP-651418	3.36/39
DH-P080DFI	1.21	EL18SF900-03	3.82	G-6255	3.35	GL-6366	3.38	GR8A30D	7.6
DH-P100DFI	1.21	EL18SF900-04	3.82	G-6260	3.35	GL-6433	3.37	GR8A45D	7.6
DH-P125DFI	1.21	EL18SF900-05	3.82	G-6261	3.35	GL-6444	3.38	GR8B30S6000	7.4
DH-S25	5.29	EL18SF900-06	3.82	G-6266	3.35	GL-6455	3.38	GR8B456000	7.4
DH-S32	5.29	EL18SF900-07	3.82	G-6333	3.34	GL-6466	3.38	GR8B706000	7.4
DH-S40	5.29	EL18SF900-08	3.82	G-6344	3.35	GL-6533	3.37	GR8BB30	7.4
DH-S50	5.29	EL18SF900-09	3.82	G-6355	3.35	GL-6544	3.38	GR8BB30A	7.4
DL-0050	3.89	EL18SF900-10	3.82	G-6366	3.35	GL-6555	3.38	GR8BB45	7.4
DL-0051	3.89	EL22F230	3.83	G-6433	3.34	GL-6566	3.38	GR8BB45A	7.4
DL-0106	3.89	EL22F231	3.83	G-6444	3.35	GL-6633	3.37	GR8BB4530B	7.5
DL-0108	3.89	EL22F233	3.83	G-6455	3.35	GL-6644	3.38	GR8BB70	7.4
DL-0124	3.89	EL22F250	3.84	G-6466	3.35	GL-6655	3.38	GR8BB70A	7.4
E-0220	3.30	EL22F251	3.84	G-6533	3.34	GL-6666	3.38	GR8BC30	7.5
E-0222	3.30	EL22F255	3.84	G-6544	3.35	GL-6733	3.37	GR8BC45	7.5
E-0240	3.30	EL22F333	3.83	G-6555	3.35	GL-6744	3.38	GR8BC70	7.5
E-0244	3.30	EL22F355	3.84	G-6566	3.35	GL-6755	3.38	GR8BL45	7.4
E-0270	3.30	EL22F433	3.83	G-6633	3.34	GL-6766	3.38	GR8BL70	7.5
E-0277	3.30	EL22F455	3.84	G-6644	3.35	GL-6833	3.37	GR8C30	7.4

PART NO.	PAGE	PART NO.	PAGE	PART NO.	PAGE	PART NO.	PAGE	PART NO.	PAGE
GR8C45	7.4	GZR-102	3.46	HZ9PB631014	5.23	HZE05Z600	4.9	HZE2C15GM	4.6
GR8C70	7.4	GZR-V10004	3.20	HZ9PBS400318	5.23	HZE05Z600SS	4.9	HZE2D15GM	4.6
GR8CJ30C	7.5	GZR-V10006	3.20	HZ9PBS400618	5.23	HZE05Z601	4.9	HZE2F15G	4.3
GR8CJ30D	7.5	GZR-V10008	3.20	HZ9PBS401018	5.23	HZE05Z602	4.9	HZE2G	4.16
GR8CJ45C	7.5	GZR-V20004	3.39	HZ9PBS500314	5.23	HZE05Z603	4.9	HZE2GD	4.18
GR8CJ45D	7.5	GZR-V20006	3.39	HZ9PBS500614	5.23	HZE05Z610	4.9	HZE2L15G	4.4
GR8CJ70C	7.5	GZR-V20008	3.39	HZ9PBS501014	5.23	HZE05Z611	4.9	HZE2R15GM	4.4
GR8CJ70D	7.5	GZR-V20L004	3.39	HZ9PBS630314	5.23	HZE05Z658	4.9	HZE2R15GMV	4.4
GR8CJD30C	7.5	GZR-V20L006	3.39	HZ9PBS630614	5.23	HZE05Z660	4.9	HZE2R15GQ	4.4
GR8CJD30D	7.5	GZR-V20L008	3.39	HZ9PBS631014	5.23	HZE1B10GM	4.5	HZE2RL15GM	4.4
GR8CJD45C	7.5	GZR-VV1006	3.20	HZE0B08GM	4.5	HZE1B10GMV	4.5	HZE2Z210	4.9
GR8CJD45D	7.5	GZR-VV1008	3.20	HZE0B08GMV	4.5	HZE1B10GQ	4.5	HZE2Z300	4.9
GR8CM4530	7.4	GZR-VV1010	3.20	HZE0B08GQ	4.5	HZE1B15GM	4.5	HZE2Z310	4.9
GR8CM4545	7.4	HA	5.2	HZE0C08GM	4.6	HZE1B15GMV	4.5	HZE2Z500	4.9
GR8CM7045	7.4	HAR	5.5	HZE0D08GM	4.6	HZE1B15GQ	4.5	HZE2Z501	4.9
GR8CM7070	7.4	HB	5.6	HZE0F08G	4.3	HZE1C10GM	4.6	HZE2Z600	4.9
GR8ECI45C	7.4	HC	5.9	HZE0L08G	4.4	HZE1C15GM	4.6	HZE2Z600SS	4.9
GR8ECI45D	7.4	HD	5.13	HZE0N08G	4.7	HZE1D10GM	4.6	HZE2Z601	4.9
GR8HD4530V	7.4	HD28	5.20	HZE0P08G	4.7	HZE1D15GM	4.6	HZE2Z602	4.9
GR8HD4545V	7.4	HEA	5.20	HZE0R08G	4.4	HZE1F10G	4.3	HZE2Z603	4.9
GR8HD7045	7.4	HEC	5.20	HZE0R08GM	4.4	HZE1F15G	4.3	HZE2Z610	4.9
GR8HD7070	7.4	HED	5.20	HZE0R08GMV	4.4	HZE1G	4.16	HZE2Z611	4.9
GR8IK	7.4	HFA	5.20	HZE0R08GQ	4.4	HZE1GD	4.18	HZE2Z652	4.9
GR8LH	7.4	HFC	5.20	HZE0S08G	4.8	HZE1L10G	4.4	HZE2Z654	4.9
GR8LHD	7.4	HGC	5.16	HZE0Y08G	4.8	HZE1L15G	4.4	HZE2Z658	4.9
GR8MF40D	7.6	HGO	5.18	HZE0Z200	4.9	HZE1N10G	4.7	HZE2Z660	4.9
GR8MF50D	7.6	HGU	5.19	HZE0Z210	4.9	HZE1N1006G	4.7	HZE2Z671C	4.17
GR8MF40PD	7.6	HZ9464G	5.23	HZE0Z300	4.9	HZE1N15G	4.7	HZE2Z671L	4.17
GR8MF50PD	7.6	HZ9N0M	5.26	HZE0Z310	4.9	HZE1P10G	4.7	HZE2Z673C	4.17
GR8MFGLC	7.6	HZ9N12110060	5.27	HZE0Z401	4.9	HZE1P15G	4.7	HZE2Z673L	4.17
GR8MFGLD	7.6	HZ9N12110080	5.27	HZE0Z402	4.9	HZE1R10GM	4.4	HZE2Z674L	4.18
GR8MP12	7.6	HZ9N12111060	5.27	HZE0Z600	4.9	HZE1R10GMV	4.4	HZE3B25GS	4.12
GR8MP18	7.6	HZ9N12111080	5.27	HZE0Z600SS	4.9	HZE1R10GQ	4.4	HZE3B25GSQ	4.12
GR8MP19	7.6	HZ9N12A	5.27	HZE0Z601	4.9	HZE1R15GM	4.4	HZE3B25GST	4.12
GR8MP30	7.6	HZ9N12B	5.27	HZE0Z602	4.9	HZE1R15GMV	4.4	HZE3C25GS	4.14
GR8R3025	7.5	HZ9N12C	5.27	HZE0Z603	4.9	HZE1R15GQ	4.4	HZE3D25GS	4.13
GR8R4540	7.5	HZ9N1F	5.24	HZE0Z610	4.9	HZE1RL10GM	4.4	HZE3F25GS	4.10
GR8RJ30C	7.5	HZ9N1F-50	5.25	HZE0Z611	4.9	HZE1RL15GM	4.4	HZE3L25G	4.11
GR8RJ30D	7.5	HZ9N1M	5.26	HZE0Z660	4.9	HZE1S10G	4.8	HZE3N	4.14
GR8RJ45C	7.5	HZ9N2F	5.24	HZE05B08GM	4.5	HZE1S15G	4.8	HZE3R25G	4.11
GR8RJ45D	7.5	HZ9N2F-51	5.25	HZE05B08GMV	4.5	HZE1Y10G	4.8	HZE3R25GQ	4.11
GR8RJ70C	7.5	HZ9N2F-52	5.25	HZE05B08GQ	4.5	HZE1Y15G	4.8	HZE3R25GT	4.11
GR8RJ70D	7.5	HZ9NC	5.24	HZE05B10GM	4.5	HZE1Z200	4.9	HZE3Z200	4.15
GR8RMF4050AD	7.6	HZ9NC50	5.25	HZE05B10GMV	4.5	HZE1Z210	4.9	HZE3Z210	4.15
GR8RMF40C	7.6	HZ9NM08-0200	5.24	HZE05B10GQ	4.5	HZE1Z300	4.9	HZE3Z310F	4.15
GR8RMF50C	7.6	HZ9NP	5.24	HZE05C08GM	4.6	HZE1Z310	4.9	HZE3Z310R	4.15
GR8SB4530	7.7	HZ9NP40	5.24	HZE05C10GM	4.6	HZE1Z401	4.9	HZE3Z470	4.15
GR8SB4530M8	7.7	HZ9NP4004	5.26	HZE05D08G	4.6	HZE1Z402	4.9	HZE3Z600SA	4.15
GR8SCB30	7.6	HZ9NP4004M8	5.26	HZE05D10G	4.6	HZE1Z600	4.9	HZE3Z600SS	4.15
GR8SCB45	7.4	HZ9NP50	5.25	HZE05F08G	4.3	HZE1Z600SS	4.9	HZE3Z601	4.15
GR8SCI30C	7.4	HZ9P400318	5.23	HZE05F10G	4.3	HZE1Z601	4.9	HZE3Z602	4.15
GR8SCI30D	7.4	HZ9P400618	5.23	HZE05L08G	4.4	HZE1Z602	4.9	HZE3Z603	4.15
GR8SK30	7.7	HZ9P401018	5.23	HZE05L10G	4.4	HZE1Z603	4.9	HZE3Z610	4.15
GR8SK45	7.7	HZ9P500314	5.23	HZE05R08G	4.4	HZE1Z610	4.9	HZE3Z658	4.15
GR8SK70	7.6	HZ9P500614	5.23	HZE05R08GM	4.4	HZE1Z611	4.9	HZE3Z664	4.15
GR8SM3030	7.6	HZ9P501014	5.23	HZE05R08GMV	4.4	HZE1Z652	4.9	HZE7Z400	4.9
GR8SM4545	7.7	HZ9P630314	5.23	HZE05R08GQ	4.4	HZE1Z654	4.9	HZE7Z470	4.9
GR8SR40	7.7	HZ9P630614	5.23	HZE05R10G	4.4	HZE1Z658	4.9	HZE7Z480	4.9
GR8SR40D	7.7	HZ9P631014	5.23	HZE05R10GM	4.4	HZE1Z660	4.9	HZE7Z490	4.9
GR8SR50	7.7	HZ9PB400318	5.23	HZE05R10GMV	4.4	HZE1Z671C	4.17	HZRE31	4.21
GR8SR50D	7.7	HZ9PB400618	5.23	HZE05R10GQ	4.4	HZE1Z671L	4.17	HZRE32	4.21
GR8SR50M8	7.7	HZ9PB401018	5.23	HZE05RL08GM	4.4	HZE1Z673C	4.17	HZRE33	4.21
GR8SR50M8D	7.7	HZ9PB500314	5.23	HZE05RL10GM	4.4	HZE1Z673L	4.17	HZRE30300	4.21
GR8SSLC	7.7	HZ9PB500614	5.23	HZE05Z200	4.9	HZE1Z674L	4.18	HZRE30310	4.21
GR8SSLCM8	7.7	HZ9PB501014	5.23	HZE05Z210	4.9	HZE2B15GM	4.5	HZREM12L03D	4.21
GZR-100	3.20	HZ9PB630314	5.23	HZE05Z300	4.9	HZE2B15GMV	4.5	HZREM12L03L	4.21
GZR-101	3.46	HZ9PB630614	5.23	HZE05Z310	4.9	HZE2B15GQ	4.5	HZRH08G	4.20

PART NO.	PAGE	PART NO.	PAGE	PART NO.	PAGE	PART NO.	PAGE	PART NO.	PAGE
HZRP3008GA	4.19	KF-10032ASI	1.21	KF-12040	1.4	KF-16050I	1.21	KF-41040050I	1.21
HZRP3008GB	4.19	KF-10040A	1.4	KF-12040I	1.21	KF-16080I	1.21	KF-41063080	1.4
HZRP3008GC	4.19	KF-10040AI	1.21	KF-12050	1.4	KF-16125I	1.21	KF-41063080I	1.21
HZRS08G-2	4.20	KF-10040AS	1.4	KF-12050I	1.21	KF-17032	1.4	KF-41100125	1.4
HZRS08G-4	4.20	KF-10040ASI	1.21	KF-12063	1.4	KF-17032I	1.21	KF-41100125I	1.21
HZRS08G-6	4.20	KF-10050A	1.4	KF-12063I	1.21	KF-17040	1.4	KF-41160200	1.8
HZRS652	4.20	KF-10050AI	1.21	KF-12080	1.4	KF-17040I	1.21	KL	1.4
HZRS654	4.20	KF-10050AS	1.4	KF-12080I	1.21	KF-17050	1.4	KLF-14032	1.4
HZRS656	4.20	KF-10050ASI	1.21	KF-12100	1.4	KF-17050I	1.21	KLF-14040	1.4
IKP	6.10	KF-10063A	1.4	KF-12100I	1.21	KF-17080	1.4	KLF-14050	1.4
J1	1.34	KF-10063AI	1.21	KF-12125	1.4	KF-17080I	1.21	KLF-14063	1.4
J3	1.35	KF-10063AS	1.4	KF-12125I	1.21	KF-17125	1.4	KLF-14080	1.4
J64RS	1.35	KF-10063ASI	1.21	KF-12160	1.8	KF-17125I	1.21	KLF-14100	1.4
J64RT2	1.36	KF-10080A	1.4	KF-12200	1.8	KF-17160	1.8	KLF-14125	1.4
J65	1.36	KF-10080AI	1.21	KF-12250	1.9	KF-17250	1.9	KM-032000	5.29
JF-13016	1.34	KF-10080AS	1.4	KF-12320	1.9	KF-17320	1.9	KM-032050-1	5.29
JF-13025	1.34	KF-10080ASI	1.21	KF-13032	1.4	KF-18250	1.9	KM-063100-1	5.29
JF-13032	1.34	KF-10100A	1.4	KF-13032I	1.21	KF-18320	1.9	KM-125000-1	5.29
JF-13040	1.34	KF-10100AI	1.21	KF-13040	1.4	KF-19032	1.4	L1-N	2.3
JF-13050	1.34	KF-10100AS	1.4	KF-13040I	1.21	KF-19032CN	1.4	L6	2.4
JF-13063	1.34	KF-10100ASI	1.21	KF-13050	1.4	KF-19032CTA	1.4	LAE	6.9
JF-13080	1.34	KF-10125A	1.4	KF-13050I	1.21	KF-19032CTAI	1.21	LAGE	6.9
JF-13100	1.34	KF-10125AI	1.21	KF-13063	1.4	KF-19032SC	1.4	LCE	6.9
JF-14016	1.34	KF-10125AS	1.4	KF-13063I	1.21	KF-19040	1.4	LGE	6.9
JF-14025	1.34	KF-10125ASI	1.21	KF-13080	1.4	KF-19040050CN	1.4	LGP32MO25	7.7
JF-14032	1.34	KF-10160A	1.8	KF-13080I	1.21	KF-19040CTA	1.4	LGP32MO30	7.7
JF-14040	1.34	KF-10160AS	1.8	KF-13100	1.4	KF-19040CTAI	1.21	LGP32MP	7.7
JF-14050	1.34	KF-10200A	1.8	KF-13100I	1.21	KF-19040SC	1.4	LGP32PT070	7.7
JF-14063	1.34	KF-10200AS	1.8	KF-13125	1.4	KF-19050	1.4	LGP40MO25	7.7
JF-14100	1.34	KF-10250A	1.9	KF-13125I	1.21	KF-19050CTA	1.4	LGP40MO30	7.7
JF-42016	1.34	KF-10320A	1.9	KF-13160	1.8	KF-19050CTAI	1.21	LGP40MO40	7.7
JF-42025	1.34	KF-11032	1.4	KF-13200	1.8	KF-19050SC	1.4	LGP40MO45	7.7
JF-42040	1.34	KF-11032I	1.21	KF-14032AP	1.4	KF-19063	1.4	LGP40MP	7.7
JF-42050	1.34	KF-11032S	1.4	KF-14032TI	1.21	KF-19063080CN	1.4	LGP40PT080	7.7
JF-42063	1.34	KF-11032SI	1.21	KF-14040AP	1.4	KF-19063CTA	1.4	LGP40PT110	7.7
JF-42100	1.34	KF-11040	1.4	KF-14040TI	1.21	KF-19063CTAI	1.21	LKP	6.10
JF-43016	1.34	KF-11040I	1.21	KF-14050AP	1.4	KF-19063SC	1.4	LNE	6.9
JF-43025	1.34	KF-11040S	1.4	KF-14050TI	1.21	KF-19080	1.4	LUP	6.7
JF-43040	1.34	KF-11040SI	1.21	KF-14063AP	1.4	KF-19080CTA	1.4	M	1.2
JF-43050	1.34	KF-11050	1.4	KF-14063TI	1.21	KF-19080CTAI	1.21	MF-12008	1.2
JF-43063	1.34	KF-11050I	1.21	KF-14080AP	1.4	KF-19080SC	1.4	MF-12012	1.2
JF-43100	1.34	KF-11050S	1.4	KF-14080TI	1.21	KF-19100	1.4	MF-12012I	1.19
JF-601016	1.34	KF-11050SI	1.21	KF-14100AP	1.4	KF-19100125CN	1.4	MF-12020	1.2
JF-601025	1.34	KF-11063I	1.21	KF-14100TI	1.21	KF-19100CTA	1.4	MF-12020I	1.19
JF-601032	1.34	KF-11063S	1.4	KF-14125AP	1.4	KF-19100CTAI	1.21	MF-13008	1.2
JF-601040	1.34	KF-11063SI	1.21	KF-14125TI	1.21	KF-19100SC	1.4	MF-13012	1.2
JF-601050	1.34	KF-11063S	1.4	KF-14160	1.8	KF-19125CTA	1.4	MF-13012I	1.19
JF-601063	1.34	KF-11080	1.4	KF-14160AP	1.8	KF-19125CTAI	1.21	MF-13020	1.2
JF-601080	1.34	KF-11080I	1.21	KF-14200	1.8	KF-19125SC	1.4	MF-13020I	1.19
JF-601100	1.34	KF-11080S	1.4	KF-14200AP	1.8	KF-19160CTA	1.8	MF-13032I	1.20
JLE	1.37	KF-11080SI	1.21	KF-14250	1.9	KF-19200CTA	1.8	MF-13040I	1.20
JTE	1.38	KF-11100	1.4	KF-14320	1.9	KF-22025	1.4	MF-13050I	1.20
JX1	1.38	KF-11100I	1.21	KF-15032	1.4	KF-22040	1.4	MF-13063I	1.20
JX2	1.38	KF-11100S	1.4	KF-15032PI	1.21	KF-22050	1.4	MF-15008	1.2
K	1.8/9	KF-11100SI	1.21	KF-15040	1.4	KF-22080	1.4	MF-15012	1.2
KD	1.7	KF-11125	1.4	KF-15040PI	1.21	KF-23025	1.4	MF-15012PI	1.19
KDF-14032	1.7	KF-11125I	1.21	KF-15050	1.4	KF-23040	1.4	MF-15020	1.2
KDF-14040	1.7	KF-11125S	1.4	KF-15050PI	1.21	KF-23050	1.4	MF-15020PI	1.19
KDF-14050	1.7	KF-11125SI	1.21	KF-15080	1.4	KF-23080	1.4	MF-16012I	1.19
KDF-14063	1.7	KF-11160	1.8	KF-15080PI	1.21	KF-24020	1.24	MF-16020I	1.19
KDF-14080	1.7	KF-11160S	1.8	KF-15125	1.4	KF-24032	1.4	MF-17008	1.2
KDF-14100	1.7	KF-11200	1.8	KF-15125PI	1.21	KF-24040	1.4	MF-17012	1.2
KDF-14125	1.7	KF-11200S	1.8	KF-15160	1.8	KF-24050	1.4	MF-17012I	1.19
KE	1.6	KF-11250	1.9	KF-15250	1.9	KF-24080	1.4	MF-17020	1.2
KF-10032A	1.4	KF-11320	1.9	KF-15320	1.9	KF-41032	1.4	MF-17020I	1.19
KF-10032AI	1.21	KF-12032	1.4	KF-16032I	1.21	KF-41032I	1.21	MF-18032I	1.20
KF-10032AS	1.4	KF-12032I	1.21	KF-16040I	1.21	KF-41040050	1.4	MF-18040I	1.20

PART NO.	PAGE	PART NO.	PAGE	PART NO.	PAGE	PART NO.	PAGE	PART NO.	PAGE
MF-18050I	1.20	P10B34424	3.65	P10SF400	3.64	P15EB251**	3.77	P15SF100	3.70
MF-18063I	1.20	P10B36624	3.65	P10SF410	3.64	P15EB255**	3.77	P15SF110	3.70
MF-20008	1.2	P10B433	3.64	P10SF500	3.63	P15EB355**	3.77	P15SF200	3.70
MF-20012	1.2	P10B44424	3.65	P10SF505	3.63	P15EB455**	3.77	P15SF210	3.70
MF-20012I	1.19	P10B46624	3.65	P10SF515	3.64	P15EB555**	3.77	P15SF300	3.70
MF-20020	1.2	P10B533	3.64	P10SF550	3.63/64	P15EB655**	3.77	P15SF310	3.70
MF-20020I	1.19	P10B54424	3.65	P10SF560	3.63/64	P15EB755**	3.77	P15SF400	3.70
MF-20032I	1.20	P10B56624	3.65	P10SF570	3.63/64	P15EB855**	3.77	P15SF410	3.70
MF-20040I	1.20	P10B633	3.64	P10SS1204M	3.63/66	P15EF250**	3.75	P15SF499-02	3.76
MF-20050I	1.20	P10B64424	3.65	P10SS1206M	3.63/66	P15EF251**	3.75	P15SF499-03	3.76
MF-20063I	1.20	P10B66624	3.65	P10SS1208M	3.63/66	P15EF255**	3.75	P15SF499-04	3.76
MF-21008	1.2	P10B733	3.64	P10SS1210M	3.63/66	P15EF355**	3.75	P15SF499-05	3.76
MF-21012	1.2	P10B74424	3.65	P10SS1212M	3.63/66	P15EF455**	3.75	P15SF499-06	3.76
MF-21012I	1.19	P10B76624	3.65	P10SS1404M	3.63/66	P15EF555**	3.75	P15SF499-07	3.76
MF-21020	1.2	P10B833	3.64	P10SS1406M	3.63/66	P15EF655**	3.75	P15SF499-08	3.76
MF-21020I	1.19	P10B84424	3.65	P10SS1408M	3.63/66	P15EF755**	3.75	P15SF499-09	3.76
MF-21032I	1.20	P10B86624	3.65	P10SS1410M	3.63/66	P15EF855**	3.75	P15SF499-10	3.76
MF-21040I	1.20	P10F230	3.62	P10SS1412M	3.63/66	P15F230	3.68	P15SF500	3.70
MF-21050I	1.20	P10F231	3.62	P10STR01	3.63	P15F231	3.68	P15SF505	3.70
MF-21063I	1.20	P10F233	3.62	P10STR02	3.63	P15F233	3.68	P15SF515	3.70
MF-22016	1.2	P10F24024	3.63	P10STR05	3.63	P15F24024	3.69	P15SF550	3.70
MF-22020	1.2	P10F24124	3.63	P15B230	3.71	P15F24124	3.69	P15SF560	3.70
MF-23012	1.2	P10F24424	3.63	P15B231	3.71	P15F24424	3.69	P15SF570	3.70
MF-23020	1.2	P10F26024	3.63	P15B233	3.71	P15F26024	3.69	P15SS1204M	3.70
MF-24012	1.2	P10F26124	3.63	P15B24024	3.71	P15F26124	3.69	P15SS1204MFP	3.70
MF-24020	1.2	P10F26624	3.63	P15B24124	3.71	P15F26624	3.69	P15SS1204MP	3.70
MP	1.39	P10F333	3.62	P15B24424	3.71	P15F333	3.68	P15SS1206M	3.70
MPF-300035A	1.39	P10F34424	3.63	P15B26024	3.71	P15F34424	3.69	P15SS1208M	3.70
MPF-300035N	1.39	P10F36624	3.63	P15B26124	3.71	P15F36624	3.69	P15SS1208MF	3.70
MPF-300035T	1.39	P10F433	3.62	P15B26624	3.71	P15F433	3.68	P15SS1404M	3.70
MPF-310035C	1.39	P10F44424	3.63	P15B333	3.71	P15F44424	3.69	P15SS1404MFP	3.70
MPF-310035L	1.39	P10F46624	3.63	P15B34424	3.71	P15F46624	3.69	P15SS1404MP	3.70
NFZ	2.9	P10F533	3.62	P15B36624	3.71	P15F533	3.68	P15SS1406M	3.70
NQZ	2.8	P10F54424	3.63	P15B433	3.71	P15F54424	3.69	P15SS1408M	3.70
NTZ	2.8	P10F56624	3.63	P15B44424	3.71	P15F56624	3.69	P15SS1408MF	3.70
OV	1.24	P10F633	3.62	P15B46624	3.71	P15F633	3.68	P15STR01	3.70
OVF-11018	1.24	P10F64424	3.63	P15B533	3.71	P15F64424	3.69	P15STR02	3.70
OVF-11025	1.24	P10F66624	3.63	P15B54424	3.71	P15F66624	3.69	P15STR05	3.70
OVF-11032	1.24	P10F733	3.62	P15B56624	3.71	P15F733	3.68	PK	1.21
OVF-11040	1.24	P10F74424	3.63	P15B633	3.71	P15F74424	3.69	PM	1.19/20
OVF-11050	1.24	P10F76624	3.63	P15B64424	3.71	P15F76624	3.69	PRM	1.22
OVF-11063	1.24	P10F833	3.62	P15B66624	3.71	P15F833	3.68	PS14100	3.45
OVF-11080	1.24	P10F84424	3.63	P15B733	3.71	P15F84424	3.69	PS14200	3.45
OVF-12018	1.24	P10F86624	3.63	P15B74424	3.71	P15F86624	3.69	PS15000	3.45
OVF-12025	1.24	P10SB100	3.65	P15B76624	3.71	P15SB100	3.72	PS15100	3.45
OVF-12032	1.24	P10SB107	3.65	P15B833	3.71	P15SB110	3.72	PS15200	3.45
OVF-12040	1.24	P10SB110	3.65	P15B84424	3.71	P15SB200	3.72	PS15300	3.45
OVF-12050	1.24	P10SB117	3.65	P15B86624	3.71	P15SB210	3.72	PS15310	3.46
OVF-12063	1.24	P10SB200	3.65	P15D24024	3.69	P15SB300	3.72	PS15320	3.46
OVF-12080	1.24	P10SB207	3.65	P15D24124	3.69	P15SB310	3.72	PS15330	3.46
OVF-13018	1.24	P10SB210	3.65	P15D24424	3.69	P15SB400	3.72	PS15340	3.46
OVF-13025	1.24	P10SB217	3.65	P15D26024	3.69	P15SB410	3.72	PS15350	3.46
OVF-13032	1.24	P10SB304	3.65	P15D26124	3.69	P15SB499-02	3.78	PS15360	3.46
OVF-13040	1.24	P10SB314	3.65	P15D26624	3.69	P15SB499-03	3.78	PS15370	3.46
OVF-13050	1.24	P10SB404	3.65	P15D34424	3.69	P15SB499-04	3.78	PSC26024	3.43
OVF-13063	1.24	P10SB414	3.65	P15D36624	3.69	P15SB499-05	3.78	PSC26124	3.43
OVF-13080	1.24	P10SB500	3.65	P15D44424	3.69	P15SB499-06	3.78	PSC26624	3.43
P10B230	3.64	P10SB505	3.65	P15D46624	3.69	P15SB499-07	3.78	PSC36624	3.43
P10B231	3.64	P10SB550	3.65	P15D54424	3.69	P15SB499-08	3.78	PSC46624	3.43
P10B233	3.64	P10SB560	3.65	P15D56624	3.69	P15SB499-09	3.78	PSC56624	3.43
P10B24024	3.65	P10SB570	3.65	P15D64424	3.69	P15SB499-10	3.78	PSC66624	3.43
P10B24124	3.65	P10SF100	3.63	P15D66624	3.69	P15SB500	3.72	PSC76624	3.43
P10B24424	3.65	P10SF110	3.63	P15D74424	3.69	P15SB502	3.78	PSC86624	3.43
P10B26024	3.65	P10SF200	3.63	P15D76624	3.69	P15SB505	3.72	PSK100145	3.46
P10B26124	3.65	P10SF210	3.63	P15D84424	3.69	P15SB550	3.72	PSK200145	3.46
P10B26624	3.65	P10SF300	3.64	P15D86624	3.69	P15SB560	3.72	PSK200290	3.46
P10B333	3.64	P10SF310	3.64	P15EB250**	3.77	P15SB570	3.72	PSK200725	3.46

PART NO.	PAGE	PART NO.	PAGE	PART NO.	PAGE	PART NO.	PAGE
PSK300145	3.46	RTF-13050	2.6	TSCFN32S0500	3.73	YDA0806	5.22
PSK401	3.46	RTF-13063	2.6	TSCFN32S1000	3.73	YDA1007	5.22
PSP26024	3.44	S1	1.30	TZ-F478	3.87	YDA1210	5.22
PSP26124	3.44	S5	1.31	TZ-F4M12	3.87	YDA1412	5.22
PSP26624	3.44	SF-12016	1.30	TZ-F578	3.87	YDA2015	5.22
PSP36624	3.44	SF-12025	1.30	TZ-F5M12	3.87	YDA2525	5.22
PSP46624	3.44	SF-12032	1.30	TZ-F4M12-B	3.87	YDA2725	5.22
PSP56624	3.44	SF-12040	1.30	TZ-M4M12-B	3.87	YDR1415	5.22
PSP66624	3.44	SF-12050	1.30	TZ-M4M12-BT	3.87	YDR2025	5.22
PSP76624	3.44	SF-13016	1.30	TZ-M4M12-D	3.87	YDR2525	5.22
PSP86624	3.44	SF-13025	1.30	TZ-M578	3.87	YDR2540	5.22
PSR220	3.44	SF-13032	1.30	TZ-M578T	3.87	YDR3625	5.22
PSR221	3.44	SF-13040	1.30	TZ-M5M12	3.87	YDR3650	5.22
PSR222	3.44	SF-13050	1.30	TZ-M5M12T	3.87	YF210061D	3.98
PSR223	3.44	SF-24016	1.30	UABM	6.5	YF210062D	3.98
PSR322	3.44	SF-24025	1.30	UABP	6.5	YF210082D	3.98
PSR422	3.44	SF-24032	1.30	UAEP	6.9	YF210151S	3.98
PSR522	3.44	SF-26016	1.30	UAGP	6.8	YF210201S	3.98
PSR622	3.44	SF-26025	1.30	UANM	6.5	YF210251S	3.98
PSR722	3.44	SF-26032	1.30	UANP	6.5	YF310061D	3.98
PSR822	3.44	SF-27016	1.30	UBF	6.10	YF310082D	3.98
R	1.26	SF-27025	1.30	UBK	6.10	YFDA-0211	3.98
RM	1.12	SF-27032	1.30	UCBH	6.4	YFDA-0223	3.98
RN	1.14	SF-28016	1.30	UCBL	6.4	YFDA-0224	3.98
RO	1.13	SF-28025	1.30	UCBM	6.4	YFDB-0211	3.98
RP	1.11	SF-28032	1.30	UCBP	6.4	YFDB-0223	3.98
RPF-10040A	1.11	TC161812	3.87	UCBQ	6.4	YFDB-0224	3.98
RPF-10050A	1.11	TC8I412	3.87	UCBT	6.4	YG-6300	3.99
RPF-10063A	1.11	TC8I808	3.87	UCDP	6.4	YMA	2.10
RPF-11016	1.11	TC8U412	3.87	UCIM	6.4	YMP	2.10/11
RPF-11020	1.11	TC-E	6.9	UCIP	6.4	YR2	1.27
RPF-11025	1.11	TCR32ID	3.87	UCNM	6.4	YR240	3.94
RPF-12016	1.11	TCR32UD	3.87	UCNP	6.4	YR250	3.94
RPF-12020	1.11	TCXC	3.86	UGM	6.7	YR260	3.94
RPF-12025	1.11	TCXD	3.86	UGP	6.7	YR270	3.95
RPF-12040	1.11	TCXEC	3.86	UGPS	6.7	YR280	3.95
RPF-12050	1.11	TCXEN	3.86	UKP	6.10	YR3003	1.28
RPF-12063	1.11	TCXLKA	3.86	ULA	6.6	YR3007	1.28
RPF-13016	1.11	TCXLKB	3.86	ULB	6.5	YR3010	1.28
RPF-13020	1.11	TCXP	3.86	ULL	6.5	YR3020	1.28
RPF-13025	1.11	TCXPN	3.86	ULM	6.5	YR3030	1.28
RPF-13040	1.11	TCXUS78	3.87	ULO	6.6	YR3050	1.28
RPF-13050	1.11	TFP010	3.87	ULP	6.5	YR3070	1.28
RPF-13063	1.11	TFP060	3.87	ULR	6.5	YR3100	1.28
RPF-14040	1.11	TFP178	3.87	ULT	6.6	YR3200	1.28
RPF-14050	1.11	TFP257	3.87	ULX	6.6		
RPF-14063	1.11	TIM06B	3.46	ULY	6.6		
RPF-28016	1.11	TIM06M	3.46	ULZ	6.6		
RPF-28020	1.11	TIM1024	3.65	UP	6.10		
RPF-28025	1.11	TIM10B	3.46	UPD	6.8		
RPF-28032	1.11	TIM10M	3.46	UPR	6.8		
RPF-28040	1.11	TIM151806	3.72	USC	6.7		
RPF-28050	1.11	TIM1524	3.72	USL	6.7		
RPF-28063	1.11	TIM1536	3.72	USP	6.7		
RQ	1.17	TIM20M	3.46	USP50U	6.7		
RS	1.16	TSCF000	3.46	USS	6.7		
RSF-09032	1.16	TSCF24S0300	3.36	USSL	6.7		
RSF-09040	1.16	TSCF24S0500	3.36	UST	6.7		
RSF-09050	1.16	TSCF24S1000	3.36	VL1	1.32		
RSF-09063	1.16	TSCFN16D0300	3.87	W	1.25		
RSF-09080	1.16	TSCFN16D0500	3.87	WF-50012	1.25		
RSF-09100	1.16	TSCFN16D1000	3.87	WF-50020	1.25		
RT	2.6	TSCFN24S000	3.20	WF-50032	1.25		
RTF-12025	2.6	TSCFN24S0300	3.20	WF-50040	1.25		
RTF-12050	2.6	TSCFN24S0500	3.20	WF-50050	1.25		
RTF-12063	2.6	TSCFN24S1000	3.20	WF-50063	1.25		
RTF-13025	2.6	TSCFN32S0300	3.73	WF-50080	1.25		



UNIVER S.p.A.

Headquarters

20128 **Milano**
Via Eraclito, 31
Tel. +39 02 25298.1
Fax +39 02 2575254
info@univer-group.com
www.univer-group.com

UNIVER SERVICE S.r.l.

Headquarters

20128 **Milano**
Via Empedocle, 20
Tel. +39 02 25298.1
Fax +39 02 25298370
universervice@universervice.it
www.universervice.it

Branch Offices

LOMBARDIA

20099 - Sesto San Giovanni **Milano**
Via G. di Vittorio, 307/20
Tel. +39 02 26261304
Fax +39 02 24300375
universervice@universervice.it

PIEMONTE/LIGURIA/VALLE D'AOSTA

10071 Borgaro Torinese **Torino**
Via Veneto, 18
Tel. +39 011 4501871
Fax +39 011 4502898
torino@universervice.it

VENETO/FRIULI VENEZIA-GIULIA TRENTINO-ALTO ADIGE

30030 Vigonovo **Venezia**
Via Prima strada 16/A - Loc. Galta
Tel. +39 049 9834140
Fax +39 049 9833972
vigonovo@universervice.it

EMILIA ROMAGNA/CENTER-SOUTH

40069 Zola Predosa **Bologna**
Via Balzani, 5
Tel. +39 051 753907
Fax +39 051 6184751
bologna@universervice.it

UNIVER DO BRASIL S/A

BRAZIL - 13474-764
Americana **São Paulo - SP**
Rua do Polyester, 29
Distrito Industrial Abdo Najar
Tel. +55 19 3113-9400
atendimento@univer.com.br

UNIVER CHINA

CHINA - Shanghai
399 Fu Te North Road,
Free Zone, Pudong
info@univer-china.com

UNIVER FRANCE S.a.s.

FRANCE - 68000
Colmar
1, rue Denis Papin
Tel. +33 03 89210900
Fax +33 03 89216850
info@univer-france.fr

UNIVER G.m.b.H.

GERMANY - D-65428
Rüsselsheim
Eisenstraße 51
Tel. +49 6142 40832-0
Fax +49 6142 40832-90
info@univer-gmbh.de

UNIVER NORTH AMERICA

USA - 48312
Sterling Heights - **Michigan**
6620 Cobb Drive
Tel. +1 248 299 0525
Fax +1 248 299 0528
info@univer-group.us

UNIVER POLSKA Sp. z o.o.

POLAND - 25-663
Kielce
ul. K. Olszewskiego 21E
Tel. +48 41 278 72 53
Fax +48 41 278 72 54
univer@univer-group.pl

UNIVER S.L.

SPAIN - 08210
Barbera Del Valles **Barcelona**
Ronda Industria, 26 - 28
Tel. +34 93 7297360
Fax +34 93 7297380
univer@univerweb.com

Distributors worldwide:

Get in touch with UNIVER Sales Department
or visit our website www.univer-group.com



www.univer-group.com

UNIVER S.p.A.

Headquarters

20128 Milano - ITALY

Via Eraclito, 31

Tel. +39 02 25298.1

Fax +39 02 2575254

info@univer-group.com

www.univer-group.com



www.univer-group.com