



Cylinders
High-Tech
Valves
Air treatment
Accessories
Power Clamps
GR8 Tooling

BUSINESS PROFILE

PRODUCT HISTORY

PNEUMATIC PRODUCT NEWS

AUTOMOTIVE PRODUCT NEWS

SALES NETWORK

1

Cylinders



2

High-Tech



3

Valves



4

Air Treatment



5

Accessories



6

Power clamps



7

GR8 Tooling



UNIVER S.p.A.
Headquarters
20128 Milano - ITALY
Via Eraclito, 31
Tel. +39 02 25298.1
Fax +39 02 2575254
info@univer-group.com
www.univer-group.com

In light of technical updates, **Univer S.p.A.** reserves the right to modify technical features of their products with no obligation to issue prior notice.

Information contained in the present catalogue is pure indication, for further details about product technical features and related parameter values to be respected for a proper functioning, please refer to the datasheets available at:
www.univer-group.com

All rights reserved to **Univer S.p.A.** Unauthorized reproduction prohibited.



Since 1971 Leader in Industrial Automation



Early stages



Pneumatics



Automotive



GR8 Tooling



UNIVER has started its activity in the field of industrial automation during the 1970s, with the production of its first series of pneumatic valves and poppet valves for vacuum.



In the following decades, the widening range of technologically advanced and original pneumatic components has allowed the continuous growth and development of the company, which has become one of the major Italian businesses in the production of industrial automation equipment.



In 2000, after many years of experience in the supply of pneumatic components to the automotive market, the Automotive Division was created, thus developing numbers of solutions for BIW in the automotive industry.

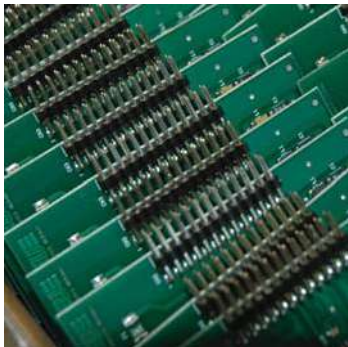


New entry, the Division of Modular Tooling Systems (GR8) represents the new challenge in the press field and handling of metal sheets in Automotive and Industrial Automation.

Some of our customers



BUSINESS PROFILE



Electronics



Univer Service



Univer Group



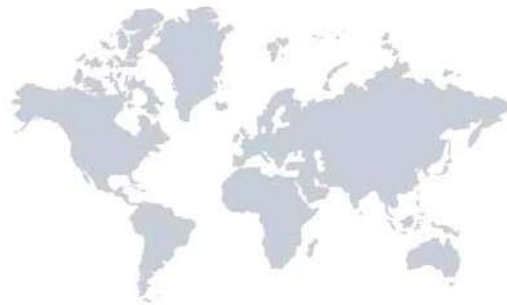
The Electronic Division, supporting both Pneumatic Automation and Automotive divisions, is specialized in the study, design and manufacturing of the electric and electronic devices which are integrated in UNIVER products.



In Italy, the commercial company **UNIVER SERVICE S.r.l.** controls the domestic market and guarantees a quick and efficient service, thanks to different operational offices and distributors in the whole country.



The UNIVER Group has many direct branches and an active distribution network covering the most important industrialized areas.



Innovation
Research and Development
Quality
Training
Communication

www.univer-group.com





Since 1971 Leader in Industrial Automation



First valve series



ISO 6431 Pneumatic Cylinders



10 mm Nanovalve



2/3 stage Telescopic Pneumatic Cylinders

1970

1980

1990



- | | | |
|--|--|---|
| <p>1971 Foundation of UNIVER company</p> <p>1973 Poppet valves for compressed air and vacuum</p> | <p>1980 Valves according to ISO 5599 (Industry Award)</p> <p>1982 UNIVERSAL series valves</p> <p>1986 Cylinders and mounting elements according to ISO 6431 (first cylinders on the market with extruded aluminium profile)</p> <p>1988 Cylinders with antirotation piston and octagonal tube
Electrically actuated microvalves
Rodless cylinders (patented)</p> <p>1989 Rotating cylinders (patented)
Short-stroke cylinders</p> | <p>1991 10 mm Nanovalve
G6 - G7 - G8 series valves</p> <p>1992 Slide units in extruded aluminium profile</p> <p>1993 Cybrain programmable actuators (patented)</p> <p>1997 Telescopic cylinders (patented)</p> <p>1998 Locking units (patented)</p> <p>1999 Compact cylinders with supplied adjustable cushioning standard (patented)</p> |
|--|--|---|

PRODUCT HISTORY



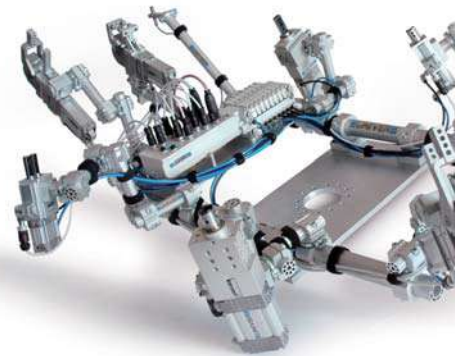
Pneumatic and Electric Power Clamps



COMPACT Valves



ISO 15552 Pneumatic Cylinders



Modular Tooling System

2000

2010

- 2000** Combobox valves
- 2001** Pneumatic power clamps and retractable locating pin units
- 2002** Oval cylinders
- 2003** Electric cylinders (patented)
Electric power pivots
Electric power clamps and retractable locating pin units
- 2004** Valves according to ISO 15407/VDMA 24563
Serial communication control blocks
Pneumatic grippers
- 2005** Pneumatic power pivots (patented)
- 2006** 10 mm Nanovalve - 2nd generation
- 2007** COMPACT 10/15 mm valves
- 2008** TC Serial communication control system
- 2009** JL Guided compact cylinders

- 2010** KL Cylinders according to ISO 15552
- 2011** Compact cylinders Ø 80-100 according to ISO 21287
HZE Air treatment system
ISO 15552 Pneumatic cylinders
- 2012** 10 mm bistable Nanovalves
Marking unit
- 2013** P15E 15 mm COMPACT Valves
GR8 Modular Tooling System
- 2014** Short Stroke Cylinders - Tube New Design
Valves with panel operation
Pneumatic Gripper



Since 1971 Leader in Industrial Automation



KL

Ø 32 ÷ 125 mm Pneumatic Cylinders

Clean profile

Easier to clean

Quick installation

Sensors and connections on one side

UNIVER Technology

Strong and Reliable

ISO 15552

Interchangeability



P15E

15 mm COMPACT Valves

G1/8 - Threaded body and for sub-base mounting

High flow rate

Flow rate higher than 800 NI/min

Reduced dimensions

Body width 15 mm

Complete solution

Versions available 5/2 - 5/3 - 3/2+3/2

PNEUMATIC PRODUCT NEWS



LATCHING
Magnetic memory

B10/B11/B12

ISO 15218 10 mm Nanovalves

Low consumption B10

Standard B11

High flow rate B12

B11

Multipolar Sub-base

Compact

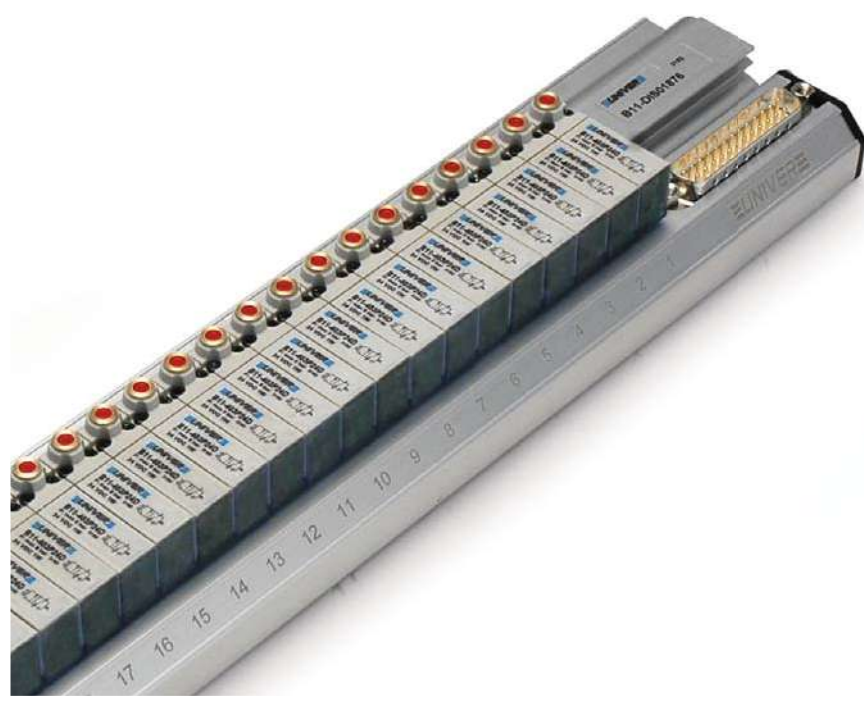
For 10 mm Nanovalves - ISO 15218

Multiple Sub-bases

Up to 24 valve places

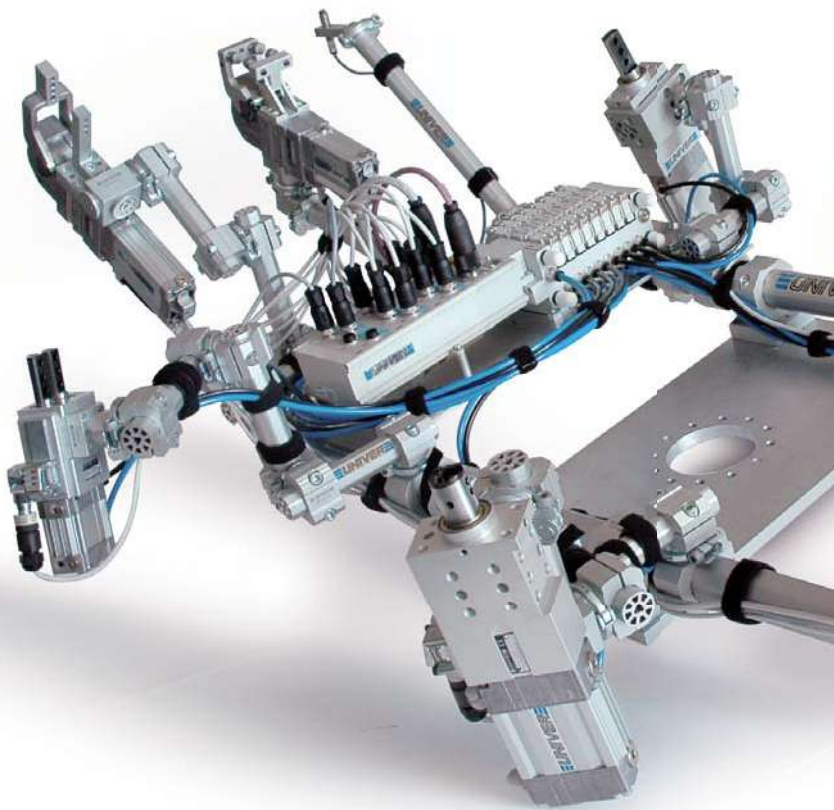
Serial Communication System

TC series Connection





Since 1971 Leader in Industrial Automation



GR8

Modular Tooling System

High precision

High level of positional repeatability;
low deflection

Modular components

Considerable reduction of mounting components

Quick installation and set up

No welding or doweling required, easily
replaceable components

Fully adjustable

Unlimited orientation in space and free
configurations

FULLY CUSTOMIZABLE

Multiple configurations

EFFICIENT SYSTEM

A small range of standardized mounting elements
facilitates the sizing and the design of the tooling

PATENT PENDING



AUTOMOTIVE PRODUCT NEWS

NEW

LGP

Pneumatic Gripper

Stepless adjustable opening angle

From 0° to 160°

Toggle joint mechanism

Irreversible movement- without air supply

Two-sided sensor mounting position

Left and right side

360° Unlimited orbital mounting adjustment

Integrated shock absorber dampening system



- Limited air consumption
- UNIVER original electronic sensor with M12 swivel connector
- Easily field adjustable sans opening
- No maintenance required



Since 1971 Leader in Industrial Automation

Univer Service



In Italy, the commercial company **UNIVER SERVICE S.r.l.** controls the domestic market and guarantees a quick and efficient service, thanks to different operational offices and distributors in the whole country.



UNIVER SERVICE S.r.l.
Headquarters
20128 Milano - ITALY
Via Empedocle, 20
Tel. +39 02 25298.1
Fax +39 02 25298370
universervice@universervice.it

LOMBARDIA



UNIVER SERVICE S.r.l.
Milano
universervice@universervice.it



UNIVER SERVICE S.r.l.
Bergamo
castellicalepio@universervice.it



UNIVER SERVICE S.r.l.
Como
monguzzo@universervice.it

PIEMONTE/LIGURIA/VALLE D'AOSTA



UNIVER SERVICE S.r.l.
Torino
torino@universervice.it

EMILIA ROMAGNA - CENTRO/SUD



UNIVER SERVICE S.r.l.
Bologna
bologna@universervice.it

VENETO/FRIULI-VENEZIA GIULIA/TRENTINO-ALTO ADIGE



UNIVER SERVICE S.r.l.
Venezia
vigonovo@universervice.it

www.univer-group.com



SALES NETWORK

Univer Group



The UNIVER Group has many direct branches and an active distribution network covering the most important industrialized areas.



UNIVER S.p.A.
Headquarters
20128 Milano - ITALY
Via Eraclito, 31
Tel. +39 02 25298.1
Fax +39 02 2575254
info@univer-group.com

BRAZIL



UNIVER do Brasil S/A
univerbrasil@univer.com.br

FRANCE



UNIVER FRANCE Sas
info@univer-france.fr

GERMANY



UNIVER G.m.b.H.
info@univer-gmbh.de

USA



UNIVER NORTH AMERICA
info@univer-group.us

POLAND



UNIVER Polska Sp. z o.o.
univer@univer-group.pl

SPAIN












UNIVER S.L.
System Supplier Pneumatic
univer@univerweb.com

1

Cylinders



	Standards-based Cylinders	M KL KE KD K	2 4 6 7 8/9
	Standards-based Compact Cylinders	RP RM RO RN RS RQ	11 12 13 14 16 17
	Oval Cylinders	OV	19
	Short-stroke Cylinders	W	20
	Rotary Cylinders	R YR2 YR3	21 22 23
	Rodless Cylinders	S1 S5 VL1	25 26 27
	Guided Cylinders	J JL JT/JX	29 32 33
	Shock Absorbers	YDA/YDR	34
	Assembly Kits	M/K RP/RM RO/RN RS/RQ S1/S5/VL1	35 36 36 36 37

CHARACTERISTICS

Ambient temperature	-20 ÷ 80 °C
Fluid	filtered air, with or without lubrication
Working pressure	1,5 ÷ 10 bar

End-caps	aluminium, crimped on barrel
Barrel	stainless steel
Piston	brass (Ø8÷16), aluminium (Ø20-25)
Guide slide	acetalic resin
Piston rod	stainless steel
Piston seal	NBR
Guide bush for piston rod	standard supplied
Shock absorber seals	NBR
Cushionings	pneumatic adjustable (Ø16÷25)


CODIFICATION KEY

M	1	0	0	0	2	5	0	0	5	0		
1	2	3	4	5	6	7						

1 Series	2 Type	3 Version
M = Ø8÷25 mm - ISO 6432 Microcylinders	1 = Stainless steel piston rod (standard version) 2 = Chromium-plated steel piston rod (to be used only with locking unit) 3 = Reduced version with stainless steel piston rod	00 = D.A. Standard version 01 = D.A. Through piston rod 50 = D.A. With adjustable cushionings (Ø16÷25) D.A. = Double acting S.A. = Single acting

4 Bore (mm)	5 Stroke (mm)	6 Option	7 Magnetic
008 = Ø8 010 = Ø10 012 = Ø12 016 = Ø16 020 = Ø20 025 = Ø25	0010 = 10 0080 = 80 0250 = 250 0020 = 20 0100 = 100 0300 = 300 0025 = 25 0125 = 125 0320 = 320 0030 = 30 0150 = 150 0400 = 400 0040 = 40 0160 = 160 0500 = 500 0050 = 50 0175 = 175 0075 = 75 0200 = 200	F = Preset for locking unit reduced protrusion	M = Magnetic version (Ø10÷25)

M190 version with high temperature seals (Max 120°C) available upon request

FIXING ELEMENTS AND ACCESSORIES

Ø	Female fork with clips	Articulated self-lubricating fork	Fork with axially mounted articulated pin	Fork with angle mounted articulated pin	Floating joint	Female rear hinge	Angle bracket	Flange	Nut for end-cap	Holder for DF sensor	DF sensor
8											
10	MF-15008	MF-17008	-	-	-	MF-21008	MF-13008	MF-12008	MF-20008	-	DF
12	MF-15012	MF-17012	MF-22016	MF-23012	MF-24012	MF-21012	MF-13012	MF-12012	MF-20012	DH-M10DF	
16	MF-15012	MF-17012	MF-22016	MF-23012	MF-24012	MF-21012	MF-13012	MF-12012	MF-20012	DH-M12DF	
20	MF-15020	MF-17020	MF-22020	MF-23020	MF-24020	MF-21020	MF-13020	MF-12020	MF-20020	DH-M16DF	
25	KF-15032	KF-17032	KF-22025	KF-23025	KF-24032	MF-21020	MF-13020	MF-12020	MF-20020	DH-M20DF	

Ø	Holder for DH sensor	DH sensor
8		
10	-	DH
12	DH-M10	
16	DH-M12	
20	DH-M16	
25	DH-M20	

■ Through piston rod



■ Reduced version with adjustable cushionings



KL **NEW**

CLEAN PROFILE

Easier to clean

QUICK INSTALLATION

Sensors and connections on one side

UNIVER TECHNOLOGY

Strong and Reliable

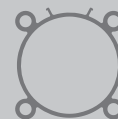
ISO 15552

Interchangeability



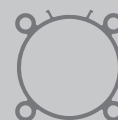
KE

Ø 32 ÷ 125 mm



KL

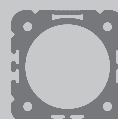
Ø 32 ÷ 125 mm



NEW CLEAN PROFILE

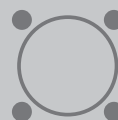
KD

Ø 32 ÷ 125 mm



K 160/200

Ø 160 - 200 mm



KIT Assembly Kit
available for all series



CHARACTERISTICS

Ambient temperature	-20 ÷ 80 °C
Fluid	filtered air, with or without lubrication
Working pressure	1,5 ÷ 10 bar
End-caps	die-cast aluminium
Barrel	anodized aluminium
Piston	die-cast aluminium
Guide slide	acetalic resin
Piston rod	chromium-plated steel, stainless steel upon request
Piston seal	NBR
Guide bush for piston rod	UNIVER Original self-lubricating and self-aligning
Shock absorber seals	NBR
Cushionings	pneumatic adjustable
Other available versions	tandem, two-position tandem, opposed, with common piston rod (upon request)


CODIFICATION KEY

K	L	2	0	0	0	3	2	0	0	5	0	M
1	2	3	4		5			6	7			

1 Series	2 Type	3 Version	4 Bore (mm)
KL = Ø 32÷125 mm - ISO 15552 Pneumatic Cylinders	1 = Stainless steel piston rod 2 = Chromium-plated steel piston rod	00 = D.A. Standard version 01 = D.A. Through piston rod 60 = S.A. Retracted piston rod Max stroke 50 mm 70 = S.A. Extended piston rod Max stroke 50 mm	032 = Ø32 080 = Ø80 040 = Ø40 100 = Ø100 050 = Ø50 125 = Ø125 063 = Ø63
Magnetic version standard supplied			
D.A. = Double acting S.A. = Single acting			
5 Stroke (mm)	6 Option	7 Magnetic	
0025 = 25 0150 = 150 0320 = 320 0700 = 700 0050 = 50 0160 = 160 0350 = 350 0800 = 800 0075 = 75 0175 = 175 0400 = 400 0900 = 900 0080 = 80 0200 = 200 0450 = 450 1000 = 1000 0100 = 100 0250 = 250 0500 = 500 0125 = 125 0300 = 300 0600 = 600	F = Preset for locking unit reduced protrusion G = Preset for locking unit ISO protrusion	M = Magnetic version standard supplied	

KL190 and KL290 versions with high temperature seals (Max 120°C) and versions with low temperature seals available upon request

FIXING ELEMENTS AND ACCESSORIES

Ø	Female fork with clips	Articulated self-lubricating fork	Fork with axially mounted articulated pin	Fork with angle mounted articulated pin	Floating joint	Female rear hinge with pin	Counter hinge 90° (CETOP)	Counter hinge 90°	Counter hinge 90° (CNOMO)	Narrow female hinge with pin	Articulated counter hinge
32	KF-15032	KF-17032	KF-22025	KF-23025	KF-24032	KF-10032A	KF-19032CTA	KF-19032	KF-19032CN	KF-10032AS	KF-19032SC
40	KF-15040	KF-17040	KF-22040	KF-23040	KF-24040	KF-10040A	KF-19040CTA	KF-19040	KF-19040050CN	KF-10040AS	KF-19040SC
50	KF-15050	KF-17050	KF-22050	KF-23050	KF-24050	KF-10050A	KF-19050CTA	KF-19050	KF-19040050CN	KF-10050AS	KF-19050SC
63	KF-15050	KF-17050	KF-22050	KF-23050	KF-24050	KF-10063A	KF-19063CTA	KF-19063	KF-19063080CN	KF-10063AS	KF-19063SC
80	KF-15080	KF-17080	KF-22080	KF-23080	KF-24080	KF-10080A	KF-19080CTA	KF-19080	KF-19063080CN	KF-10080AS	KF-19080SC
100	KF-15080	KF-17080	KF-22080	KF-23080	KF-24080	KF-10100A	KF-19100CTA	KF-19100	KF-19100125CN	KF-10100AS	KF-19100SC
125	KF-15125	KF-17125	-	-	-	KF-10125A	KF-19125CTA	-	KF-19100125CN	KF-10125AS	KF-19125SC
Ø	Articulated rear male hinge	Rear male hinge	Front/rear flange	Angle bracket	Front/rear hinge with floating pin	Hinge support	ISO intermediate hinge	DF sensor and DHF covering strip			
32	KF-11032S	KF-11032	KF-12032	KF-13032	KF-14032AP	KF-41032	KLF-14032	DF DHF-0020100			
40	KF-11040S	KF-11040	KF-12040	KF-13040	KF-14040AP	KF-41040050	KLF-14040				
50	KF-11050S	KF-11050	KF-12050	KF-13050	KF-14050AP	KF-41040050	KLF-14050				
63	KF-11063S	KF-11063	KF-12063	KF-13063	KF-14063AP	KF-41063080	KLF-14063				
80	KF-11080S	KF-11080	KF-12080	KF-13080	KF-14080AP	KF-41063080	KLF-14080				
100	KF-11100S	KF-11100	KF-12100	KF-13100	KF-14100AP	KF-41100125	KLF-14100				
125	KF-11125S	KF-11125	KF-12125	KF-13125	KF-14125AP	KF-41100125	KLF-14125				



Tube profile with integrated sensor grooves
UNIVER Original since 2005



Recessed sensor
DF series



Magnetic piston
standard supplied



Fixing screws integrated in the end-cap profile



Sensor grooves available in different positions



Possibility to mount DH sensors with brackets



Intermediate hinge with locking system guaranteed by UNIVER AUTOMOTIVE expertise

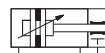
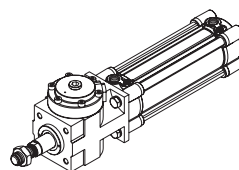


Standard fixing elements
UNIVER Original

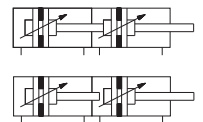
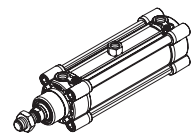
- 1 Die-cast end-caps in aluminium
- 2 Die-cast piston in aluminium
- 3 Guide slide in acetalic resin with integrated magnetic ring
- 4 Wear-resistant shock absorber seals in nitrilic rubber compound
- 5 Lip piston seals in nitrile rubber compound
- 6 **UNIVER Original** self-aligning and self-lubricating guide bush for piston rod

Further available versions

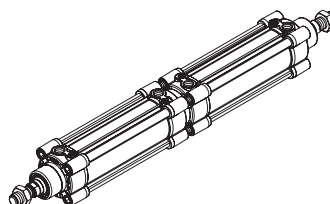
■ Cylinder with L1-N locking unit



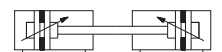
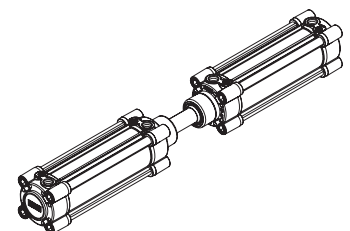
■ Tandem cylinder
Two-position tandem cylinder



■ Opposed cylinders



■ Cylinders with common piston rod



1

CHARACTERISTICS

Ambient temperature	-20 ÷ 80 °C
Fluid	filtered air, with or without lubrication
Working pressure	1,5 ÷ 10 bar

End-caps	die-cast aluminium
Barrel	anodized aluminium
Piston	die-cast aluminium
Guide slide	acetalic resin
Piston rod	chromium-plated steel, stainless steel upon request
Piston seal	NBR
Guide bush for piston rod	UNIVER Original self-lubricating and self-aligning
Shock absorber seals	NBR
Cushionings	pneumatic adjustable
Other available versions	tandem, two-position tandem, opposed, with common piston rod (upon request)



CODIFICATION KEY

K	E	2	0	0	0	3	2	0	0	5	0		
1	2	3	4				5			6	7		

1 Series	2 Type	3 Version	4 Bore (mm)
KE = Ø 32÷125 mm - ISO 15552 Pneumatic Cylinders	1 = Stainless steel piston rod 2 = Chromium-plated steel piston rod	00 = D.A. Standard version 01 = D.A. Through piston rod 60 = S.A. Retracted piston rod Max stroke 50 mm 70 = S.A. Extended piston rod Max stroke 50 mm	032 = Ø32 080 = Ø80 040 = Ø40 100 = Ø100 050 = Ø50 125 = Ø125 063 = Ø63
K = Ø 32÷125 mm - ISO 15552 Pneumatic Cylinders (former ISO 6431 VDMA 24562) (available upon request)		D.A. = Double acting S.A. = Single acting	

5 Stroke (mm)	6 Option	7 Magnetic
0025 = 25 0150 = 150 0320 = 320 0700 = 700 0050 = 50 0160 = 160 0350 = 350 0800 = 800 0075 = 75 0175 = 175 0400 = 400 0900 = 900 0080 = 80 0200 = 200 0450 = 450 1000 = 1000 0100 = 100 0250 = 250 0500 = 500 0125 = 125 0300 = 300 0600 = 600	F = Preset for locking unit reduced protrusion G = Preset for locking unit ISO protrusion	M = Magnetic version

KE190 and KE290 versions with high temperature seals (Max 120°C) and versions with low temperature seals available upon request

FIXING ELEMENTS AND ACCESSORIES

Ø	Female fork with clips	Articulated self-lubricating fork	Fork with axially mounted articulated pin	Fork with angle mounted articulated pin	Floating joint	Female rear hinge with pin	Counter hinge 90° (CETOP)	Counter hinge 90°	Counter hinge 90° (CNOMO)	Narrow female hinge with pin	Articulated counter hinge
32	KF-15032	KF-17032	KF-22025	KF-23025	KF-24032	KF-10032A	KF-19032CTA	KF-19032	KF-19032CN	KF-10032AS	KF-19032SC
40	KF-15040	KF-17040	KF-22040	KF-23040	KF-24040	KF-10040A	KF-19040CTA	KF-19040	KF-19040050CN	KF-10040AS	KF-19040SC
50	KF-15050	KF-17050	KF-22050	KF-23050	KF-24050	KF-10050A	KF-19050CTA	KF-19050	KF-19040050CN	KF-10050AS	KF-19050SC
63	KF-15050	KF-17050	KF-22050	KF-23050	KF-24050	KF-10063A	KF-19063CTA	KF-19063	KF-19063080CN	KF-10063AS	KF-19063SC
80	KF-15080	KF-17080	KF-22080	KF-23080	KF-24080	KF-10080A	KF-19080CTA	KF-19080	KF-19063080CN	KF-10080AS	KF-19080SC
100	KF-15080	KF-17080	KF-22080	KF-23080	KF-24080	KF-10100A	KF-19100CTA	KF-19100	KF-19100125CN	KF-10100AS	KF-19100SC
125	KF-15125	KF-17125	-	-	-	KF-10125A	KF-19125CTA	-	KF-19100125CN	KF-10125AS	KF-19125SC

Ø	Articulated rear male hinge	Rear male hinge	Front / rear flange	Angle bracket	Front / rear hinge with floating pin	Hinge support	ISO Intermediate hinge	ISO Intermediate hinge	DF sensor and DHF covering strip	DH sensor	Mounting bracket for DH sensor
32	KF-11032S	KF-11032	KF-12032	KF-13032	KF-14032AP	KF-41032	KLF-14032	KF-14032	DF DHF-0020100	DH	DH-K032050 DH-K032050 DH-K032050 DH-K063125 DH-K063125 DH-K063125 DH-K063125
40	KF-11040S	KF-11040	KF-12040	KF-13040	KF-14040AP	KF-41040050	KLF-14040	KF-14040			
50	KF-11050S	KF-11050	KF-12050	KF-13050	KF-14050AP	KF-41040050	KLF-14050	KF-14050			
63	KF-11063S	KF-11063	KF-12063	KF-13063	KF-14063AP	KF-41063080	KLF-14063	KF-14063			
80	KF-11080S	KF-11080	KF-12080	KF-13080	KF-14080AP	KF-41063080	KLF-14080	KF-14080			
100	KF-11100S	KF-11100	KF-12100	KF-13100	KF-14100AP	KF-41100125	KLF-14100	KF-14100			
125	KF-11125S	KF-11125	KF-12125	KF-13125	KF-14125AP	KF-41100125	KLF-14125	KF-14125			

* = Fixing elements and accessories for K series

CHARACTERISTICS

Ambient temperature	-20 ÷ 80 °C
Fluid	filtered air, with or without lubrication
Working pressure	1,5 ÷ 10 bar
End-caps	die-cast aluminium
Barrel	anodized aluminium
Piston	die-cast aluminium
Guide slide	acetalic resin
Piston rod	chromium-plated steel, stainless steel upon request
Piston seal	NBR
Guide bush for piston rod	UNIVER Original self-lubricating and self-aligning
Shock absorber seals	NBR
Cushionings	pneumatic adjustable
Other available versions	tandem, two-position tandem, opposed, with common piston rod (upon request)



CODIFICATION KEY

K	D	2	0	0	0	3	2	0	0	5	0	M
1	2	3	4	5	6	7						

1 Series	2 Type	3 Version	4 Bore (mm)
KD = Ø 32÷125 mm - ISO 15552 Pneumatic Cylinders (former ISO 6431 and VDMA 24562)	1 = Stainless steel piston rod 2 = Chromium-plated steel piston rod	00 = D.A. Standard version 01 = D.A. Through piston rod 60 = S.A. Retracted piston rod Max stroke 50 mm 70 = S.A. Extended piston rod Max stroke 50 mm	032 = Ø32 080 = Ø80 040 = Ø40 100 = Ø100 050 = Ø50 125 = Ø125 063 = Ø63
Magnetic version standard supplied		D.A. = Double acting S.A. = Single acting	

5 Stroke (mm)	6 Option	7 Magnetic
0025 = 25 0150 = 150 0320 = 320 0700 = 700 0050 = 50 0160 = 160 0350 = 350 0800 = 800 0075 = 75 0175 = 175 0400 = 400 0900 = 900 0080 = 80 0200 = 200 0450 = 450 1000 = 1000 0100 = 100 0250 = 250 0500 = 500 0125 = 125 0300 = 300 0600 = 600	F = Preset for locking unit reduced protrusion G = Preset for locking unit ISO protrusion	M = Magnetic version standard supplied

KD190 and KD290 versions with high temperature seals (max 120°C) and versions with low temperature seals available upon request

FIXING ELEMENTS AND ACCESSORIES

Ø	Female fork with clips	Articulated self-lubricating fork	Fork with axially mounted articulated pin	Fork with angle mounted articulated pin	Floating joint	Female rear hinge with pin	Counter hinge 90° (CETOP)	Counter hinge 90°	Counter hinge 90° (CNOMO)	Narrow female hinge with pin	Articulated counter hinge
32	KF-15032	KF-17032	KF-22025	KF-23025	KF-24032	KF-10032A	KF-19032CTA	KF-19032	KF-19032CN	KF-10032AS	KF-19032SC
40	KF-15040	KF-17040	KF-22040	KF-23040	KF-24040	KF-10040A	KF-19040CTA	KF-19040	KF-19040050CN	KF-10040AS	KF-19040SC
50	KF-15050	KF-17050	KF-22050	KF-23050	KF-24050	KF-10050A	KF-19050CTA	KF-19050	KF-19040050CN	KF-10050AS	KF-19050SC
63	KF-15050	KF-17050	KF-22050	KF-23050	KF-24050	KF-10063A	KF-19063CTA	KF-19063	KF-19063080CN	KF-10063AS	KF-19063SC
80	KF-15080	KF-17080	KF-22080	KF-23080	KF-24080	KF-10080A	KF-19080CTA	KF-19080	KF-19063080CN	KF-10080AS	KF-19080SC
100	KF-15080	KF-17080	KF-22080	KF-23080	KF-24080	KF-10100A	KF-19100CTA	KF-19100	KF-19100125CN	KF-10100AS	KF-19100SC
125	KF-15125	KF-17125	-	-	-	KF-10125A	KF-19125CTA	-	KF-19100125CN	KF-10125AS	KF-19125SC

Ø	Articulated rear male hinge	Rear male hinge	Front / rear flange	Angle bracket	Front / rear hinge with floating pin	Hinge support	ISO Intermediate hinge	DF sensor and DHF covering strip	Cable clamping for DF sensor
32	KF-11032S	KF-11032	KF-12032	KF-13032	KF-14032AP	KF-41032	KDF-14032	DF DHF-0020100	DF-001
40	KF-11040S	KF-11040	KF-12040	KF-13040	KF-14040AP	KF-41040050	KDF-14040		
50	KF-11050S	KF-11050	KF-12050	KF-13050	KF-14050AP	KF-41040050	KDF-14050		
63	KF-11063S	KF-11063	KF-12063	KF-13063	KF-14063AP	KF-41063080	KDF-14063		
80	KF-11080S	KF-11080	KF-12080	KF-13080	KF-14080AP	KF-41063080	KDF-14080		
100	KF-11100S	KF-11100	KF-12100	KF-13100	KF-14100AP	KF-41100125	KDF-14100		
125	KF-11125S	KF-11125	KF-12125	KF-13125	KF-14125AP	KF-41100125	KDF-14125		

CHARACTERISTICS

Ambient temperature	-20 ÷ 80 °C
Fluid	filtered air, with or without lubrication
Working pressure	1,5 ÷ 10 bar

End-caps	die-cast aluminium
Barrel	anodized aluminium
Tie-rods	zinc-plated steel
Piston	die-cast aluminium
Guide slide	acetalic resin
Piston rod	chromium-plated steel, stainless steel upon request
Piston rod scraper seals	NBR
Piston seals	polyurethane (Ø160) - NBR (Ø200)
Cushionings	pneumatic adjustable
Other available versions	tandem, two-position tandem, opposed, with common piston rod (upon request)



CODIFICATION KEY

K	2	0	0	1	6	0	0	0	8	0	
1	2	3	4	5	6						

1 Series	2 Type	3 Version	4 Bore (mm)
K = Ø 160/200 mm - ISO 15552 Pneumatic Cylinders	1 = Stainless steel piston rod 2 = Chromium-plated steel piston rod	00 = D.A. Standard version 01 = D.A. Through piston rod	160 = Ø160 200 = Ø200

D.A. = Double acting

5 Stroke (mm)	6 Magnetic
0025 = 25 0150 = 150 0320 = 320 0700 = 700 0050 = 50 0160 = 160 0350 = 350 0800 = 800 0075 = 75 0175 = 175 0400 = 400 0900 = 900 0080 = 80 0200 = 200 0450 = 450 1000 = 1000 0100 = 100 0250 = 250 0500 = 500 0125 = 125 0300 = 300 0600 = 600	M = Magnetic version

K190 and K290 versions with high temperature seals (Max 120°C) and versions with low temperature seals available upon request

FIXING ELEMENTS AND ACCESSORIES

Ø	Female fork with clips	Articulated self-lubricating fork	Female rear hinge with pin	Counter hinge 90° (CETOP)	Counter hinge 90° (CNOMO)	Narrow female hinge with pin	Articulated rear male hinge	Rear male hinge	Front/rear flange	Angle bracket	Front / rear hinge with floating pin
160											
	KF-15160	KF-17160	KF-10160A	KF-19160CTA	KF-19160200CN	KF-10160AS	KF-11160S	KF-11160	KF-12160	KF-13160	KF-14160AP
200	KF-15160	KF-17160	KF-10200A	KF-19200CTA	KF-19160200CN	KF-10200AS	KF-11200S	KF-11200	KF-12200	KF-13200	KF-14200AP

Ø	Hinge support	ISO intermediate hinge	DH sensor	Mounting bracket for DH sensor
160				
	KF-41160200	KF-14160	DH	DH-K160200
200	KF-41160200	KF-14200		DH-K160200

■ Ø160/200 Cylinder with profiled tube (version available upon request)



CHARACTERISTICS

Ambient temperature	-20 ÷ 80 °C
Fluid	filtered air, with or without lubrication
Working pressure	1,5 ÷ 10 bar

End-caps	die-cast aluminium
Barrel	anodized aluminium
Tie-rods	zinc-plated steel
Piston	die-cast aluminium
Guide slide	acetalic resin
Piston rod	chromium-plated steel, stainless steel upon request
Piston rod scraper seals	NBR
Piston seals	NBR
Cushionings	pneumatic adjustable



CODIFICATION KEY

K	2	0	0	2	5	0	0	0	8	0	
1	2	3	4	5	6						

1 Series	2 Type	3 Version	4 Bore (mm)
K = Ø 250/320 mm - ISO 15552 Pneumatic Cylinders	1 = Stainless steel piston rod 2 = Chromium-plated steel piston rod	00 = D.A. Standard version 01 = D.A. Through piston rod	250 = Ø250 320 = Ø320

D.A. = Double acting

5 Stroke (mm)	6 Magnetic
0025 = 25 0150 = 150 0320 = 320 0700 = 700 0050 = 50 0160 = 160 0350 = 350 0800 = 800 0075 = 75 0175 = 175 0400 = 400 0900 = 900 0080 = 80 0200 = 200 0450 = 450 1000 = 1000 0100 = 100 0250 = 250 0500 = 500 0125 = 125 0300 = 300 0600 = 600	M = Magnetic version

FIXING ELEMENTS AND ACCESSORIES

Ø	Female fork with clips	Articulated self-lubricating fork	Female rear hinge with pin	Rear male hinge	Front/rear flange	Angle bracket	Hinge support	ISO intermediate hinge
250								
320	KF-15250 KF-15320	KF-17250 KF-17320	KF-10250AC KF-10320AC	KF-11250C KF-11320C	KF-12250 KF-12320	KF-13250 KF-13320	KF-41250 KF-41320	KF-14250 KF-14320

Magnetic sensors upon request



Adjustable pneumatic cushioning

UNIVER Original since 1999

- No change in dimensions comparing to an equivalent cylinder without cushionings
- Standard supplied for all models

STANDARDS-BASED

Available in compliance with UNITOP and ISO 21287 standards

STANDARD AND OCTAGONAL TUBE

Available in standard version and non-rotating version with **UNIVER Original** octagonal tube



Standard



Octagonal



RP/RM



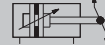
RP (UNITOP RU-2/7)
 $\varnothing 16 \div 63 \text{ mm}$



RM (ISO 21287)
 $\varnothing 16 \div 100 \text{ mm}$



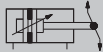
RP210



With anti-rotation guides
 $\varnothing 16 \div 63 \text{ mm}$



RO/RN



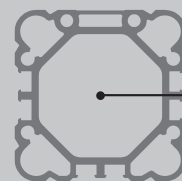
RO (UNITOP RU-2/7)
 $\varnothing 16 \div 63 \text{ mm}$



RN (ISO 21287)
 $\varnothing 16 \div 63 \text{ mm}$



Non-rotating (octagonal tube) version
 Max load (Nm)



\varnothing	Nm
16	0,5
20	0,8
25	1
32	2
40	3
50	5
63	8



Assembly Kit
 available for all series



CHARACTERISTICS

Ambient temperature	-20 ÷ 80 °C
Fluid	filtered air, with or without lubrication
Working pressure	1,5 ÷ 10 bar
End-caps	die-cast aluminium
Barrel	anodized aluminium
Piston	aluminium
Guide slide	acetalic resin
Piston rod	chromium-plated steel, stainless steel upon request
Piston seal	NBR
Guide bush for piston rod	acetalic resin
Shock absorber seals	NBR
Cushionings	pneumatic adjustable (UNIVER Original standard supplied)
Magnet	standard supplied
Other available versions	tandem, two-position tandem, opposed, with common piston rod (upon request)



CODIFICATION KEY

R	P	2	0	0	0	3	2	0	0	2	5	
1	2	3	4	5	6							

1 Series	2 Type	3 Version
RP = Ø 16÷63 mm UNITOP Compact Cylinders	1 = Stainless steel female piston rod 2 = Chromium-plated steel female piston rod Upon request 3 = Stainless steel male piston rod (Ø40÷63) 4 = Chromium-plated steel male piston rod (Ø40÷63)	00 = D.A. Standard version 01 = D.A. Through piston rod 10 = D.A. Non-rotating guided piston rod 11 = D.A. Non-rotating guided through piston rod 20 = D.A. Long piston (Ø32÷63) 60 = S.A. Retracted piston rod 70 = S.A. Extended piston rod D.A. = Double acting S.A. = Single acting

4 Bore (mm)	5 Stroke (mm)	6 Option
016 = Ø16 040 = Ø40 020 = Ø20 050 = Ø50 025 = Ø25 063 = Ø63 032 = Ø32	Single acting 0005 - 0010 (Ø16÷25) 0005 - 0010 - 0015 - 0020 - 0025 (Ø32÷63) Double acting 0005 - 0010 - 0015 - 0020 - 0025 - 0030 - 0040 0050 - 0060 - 0080	Max standard stroke 0040 (Ø16) 0050 (Ø20-25) 0080 (Ø32÷63) Max stroke with non-rotating guided piston rod (upon request) 0100 (Ø16) 0200 (Ø20-25) 0400 (Ø32-40) 0500 (Ø50-63)
		C = With flange for versions: 100-101-120-160-170 200-201-220-260-270 H = Hollow piston rod only for through piston rod versions without flange

For high temperature applications please contact our Sales Office

FIXING ELEMENTS AND ACCESSORIES

Ø	Flange for female piston rod	Rear male hinge	Rear female hinge with pin	Counter hinge 90°	Front/rear flange	Angle bracket	Intermediate hinge	Centering adaptor ring	Hinge support	DF sensor and DHF covering strip	Cable clamping for DF sensor
16	RPF-28016	RPF-11016	-	-	RPF-12016	RPF-13016	-	-	-	DHF-0020100	DF-001
20	RPF-28020	RPF-11020	-	-	RPF-12020	RPF-13020	-	-			
25	RPF-28025	RPF-11025	-	-	RPF-12025	RPF-13025	-	-			
32	RPF-28032	-	KF-10032A	KF-19032	KF-12032	KF-13032	KDF-14032	RSF-09032	KF-41032		
40	RPF-28040	-	RPF-10040A	KF-19040	RPF-12040	RPF-13040	RPF-14040	RSF-09040	KF-41040050		
50	RPF-28050	-	RPF-10050A	KF-19050	RPF-12050	RPF-13050	RPF-14050	RSF-09050	KF-41040050		
63	RPF-28063	-	RPF-10063A	KF-19063	RPF-12063	RPF-13063	RPF-14063	RSF-09063	KF-41063080		

1

CHARACTERISTICS

Ambient temperature	-20 ÷ 80 °C
Fluid	filtered air, with or without lubrication
Working pressure	1,5 ÷ 10 bar
End-caps	die-cast aluminium
Barrel	anodized aluminium
Piston	aluminium
Guide slide	acetalic resin
Piston rod	chromium-plated steel, stainless steel upon request
Piston seal	NBR
Guide bush for piston rod	acetalic resin
Shock absorber seals	NBR
Cushionings	pneumatic adjustable (UNIVER Original standard supplied)
Magnet	standard supplied
Other available versions	tandem, two-position tandem, opposed tandem, with common piston rod (upon request)



CODIFICATION KEY

R	M	3	0	0	0	3	2	0	0	2	5	
1	2	3	4		5		6					

1 Series RM = Ø 16÷100 mm - ISO 21287 Compact Cylinders	2 Type 3 = Stainless steel male piston rod 4 = Chromium-plated steel male piston rod Upon request 1 = Stainless steel female piston rod (Ø40÷100) 2 = Chromium-plated steel female piston rod (Ø 40÷100)	3 Version 00 = D.A. Standard version 01 = D.A. Through piston rod 20 = D.A. Long piston (Ø32÷63) 60 = S.A. Retracted piston rod 70 = S.A. Extended piston rod D.A. = Double acting S.A. = Single acting
---	--	---

4 Bore (mm) 016 = Ø16 050 = Ø50 020 = Ø20 063 = Ø63 025 = Ø25 080 = Ø80 032 = Ø32 100 = Ø100 040 = Ø40	5 Stroke (mm) Single acting 0005 - 0010 (Ø16÷25) 0005 - 0010 - 0015 - 0020 - 0025 (Ø32÷100) Double acting 0005 - 0010 - 0015 - 0020 - 0025 - 0030 - 0040 0050 - 0060 - 0080	6 Option Max standard stroke 0040 (Ø16) 0050 (Ø20-25) 0080 (Ø32÷63) H = Hollow piston rod only for through piston rod versions without flange
--	--	---

For high temperature applications please contact our Sales Office

FIXING ELEMENTS AND ACCESSORIES

Ø	Female fork with clips	Articulated self-lubricating fork	Fork with axially mounted articulated pin	Fork with angle mounted articulated pin	Floating joint	Centering adaptor ring	Female rear hinge with pin	Counter hinge 90° (CETOP)	Counter hinge 90°	Counter hinge 90° (CNOMO)	Narrow female hinge with pin
16	MF-15012	MF-17012	MF-22016	MF-23012	MF-24012	-	-	-	-	-	-
20	MF-15020	MF-17020	MF-22020	MF-23020	MF-24020	-	-	-	-	-	-
25	MF-15020	MF-17020	MF-22020	MF-23020	MF-24020	-	-	-	-	-	-
32	KF-15032	KF-17032	KF-22025	KF-23025	KF-24032	RSF-09032	KF-10032A	KF-19032CTA	KF-19032	KF-19032CN	KF-10032AS
40	KF-15032	KF-17032	KF-22025	KF-23025	KF-24032	RSF-09040	KF-10040A	KF-19040CTA	KF-19040	KF-19040050CN	KF-10040AS
50	KF-15040	KF-17040	KF-22040	KF-23040	KF-24040	RSF-09050	KF-10050A	KF-19050CTA	KF-19050	KF-19040050CN	KF-10050AS
63	KF-15040	KF-17040	KF-22040	KF-23040	KF-24040	RSF-09063	KF-10063A	KF-19063CTA	KF-19063	KF-19063080CN	KF-10063AS
80	KF-15050	KF-17050	KF-22050	KF-23050	KF-24050	RSF-09080	KF-10080A	KF-19080CTA	KF-19080	KF-19063080CN	KF-10080AS
100	KF-15050	KF-17050	KF-22050	KF-23050	KF-24050	RSF-09100	KF-10100A	KF-19100CTA	KF-19100	KF-19100125CN	KF-10100AS

Ø	Articulated counter hinge	Articulated rear male hinge	Rear male hinge	Front/rear flange	Angle bracket	Front/rear hinge with floating pin	Hinge support	ISO intermediate hinge	DF sensor and DHF covering strip	Cable clamping for DF sensor
16	-	-	-	-	-	-	-	-	DF DHF-002100	DF-001
20	-	-	-	-	-	-	-			
25	-	-	-	-	-	-	-			
32	KF-19032SC	KF-11032S	KF-11032	KF-12032	KF-13032	KF-14032AP	KF-41032	KDF-14032		
40	KF-19040SC	KF-11040S	KF-11040	KF-12040	KF-13040	KF-14040AP	KF-41040050	RPF-14040		
50	KF-19050SC	KF-11050S	KF-11050	KF-12050	KF-13050	KF-14050AP	KF-41040050	RPF-14050		
63	KF-19063SC	KF-11063S	KF-11063	KF-12063	KF-13063	KF-14063AP	KF-41063080	RPF-14063		
80	KF-19080SC	KF-11080S	KF-11080	KF-12080	KF-13080	KF-14080AP	KF-41063080	KDF-14080		
100	KF-19100SC	KF-11100S	KF-11100	KF-12100	KF-13100	KF-14100AP	KF-41100125	KDF-14100		

CHARACTERISTICS

Ambient temperature	-20 ÷ 80 °C
Fluid	filtered air, with or without lubrication
Working pressure	1,5 ÷ 10 bar
End-caps	die-cast zamak (Ø 16 ÷ 25 mm) die-cast aluminium (Ø 32 ÷ 63 mm)
Barrel	anodized aluminium
Piston	aluminium
Guide slide	acetalic resin
Piston rod	chromium-plated steel, stainless steel upon request
Piston seal	NBR
Guide bush for piston rod	acetalic resin
Shock absorber seals	NBR
Cushionings	pneumatic adjustable (UNIVER Original standard supplied)
Magnet	standard supplied
Other available versions	tandem, two-position tandem, opposed tandem, with common piston rod (upon request)

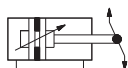


CODIFICATION KEY

R	O	2	0	0	0	3	2	0	0	2	5	
1	2	3	4		5		6					

1 Series	2 Type	3 Version
-----------------	---------------	------------------

RO = Ø 16÷63 mm UNITOP Compact Cylinders octagonal tube



1 = Stainless steel female piston rod
2 = Chromium-plated steel female piston rod

Male piston rod upon request

00 = D.A. Standard version
01 = D.A. Through piston rod
20 = D.A. Long piston (Ø32÷63)

D.A. = Double acting

4 Bore (mm)	5 Stroke (mm)	6 Option
--------------------	----------------------	-----------------

016 = Ø16 040 = Ø40
020 = Ø20 050 = Ø50
025 = Ø25 063 = Ø63
032 = Ø32

0005 - 0010 - 0015 - 0020 - 0025 - 0030 - 0040
0050 - 0060 - 0080

Max standard stroke
0040 (Ø16)
0050 (Ø20-25)
0080 (Ø32÷63)

H = Hollow piston rod only for through piston rod versions without flange

FIXING ELEMENTS AND ACCESSORIES

Ø	Rear male hinge	Rear female hinge with pin	Counter hinge 90°	Front/rear flange	Angle bracket	Intermediate hinge	Centering adaptor ring	HInge support	DF sensor and DHF covering strip	Cable clamping for DF sensor
16		-	-			-	-	-		
20	RPF-11016	-	-	RPF-12016	RPF-13016	-	-			
25	RPF-11020	-	-	RPF-12020	RPF-13020	-	-			
32	RPF-11025	-	-	RPF-12025	RPF-13025	-	-			
40	-	KF-10032A	KF-19032	KF-12032	KF-13032	KDF-14032	RSF-09032	KF-41032		
50	-	RPF-10040A	KF-19040	RPF-12040	RPF-13040	RPF-14040	RSF-09040	KF-41040050		
63	-	RPF-10050A	KF-19050	RPF-12050	RPF-13050	RPF-14050	RSF-09050	KF-41040050		
	-	RPF-10063A	KF-19063	RPF-12063	RPF-13063	RPF-14063	RSF-09063	KF-41063080		

CHARACTERISTICS

Ambient temperature	-20 ÷ 80 °C
Fluid	filtered air, with or without lubrication
Working pressure	1,5 ÷ 10 bar
End-caps	die-cast zamak (Ø16÷25) die-cast aluminium (Ø32÷63)
Barrel	anodized aluminium
Piston	aluminium
Guide slide	acetalic resin
Piston rod	chromium-plated steel, stainless steel upon request
Piston seal	NBR
Guide bush for piston rod	acetalic resin
Shock absorber seals	NBR
Cushionings	pneumatic adjustable (UNIVER Original standard supplied)
Magnet	standard supplied
Other available versions	tandem, two-position tandem, opposed tandem, with common piston rod (upon request)



CODIFICATION KEY

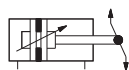
R	N	3	0	0	0	3	2	0	0	2	5	
1	2	3	4		5			6				

1 Series	2 Type	3 Version
-----------------	---------------	------------------

RN = Ø 16÷63 mm - ISO 21287
Compact Cylinders octagonal tube

3 = Stainless steel male piston rod
4 = Chromium-plated steel male piston rod

00 = D.A. Standard version
01 = D.A. Through piston rod
20 = D.A. Long piston (Ø32÷63)



Female piston rod upon request

D.A. = Double acting

4 Bore (mm)	5 Stroke (mm)	6 Option
--------------------	----------------------	-----------------

016 = Ø16 **040** = Ø40
020 = Ø20 **050** = Ø50
025 = Ø25 **063** = Ø63
032 = Ø32

0005 - 0010 - 0015 - 0020 - 0025 - 0030 - 0040
0050 - 0060 - 0080
Max standard stroke
0040 (Ø16)
0050 (Ø20-25)
0080 (Ø32÷63)

H = Hollow piston rod only for through piston rod versions without flange

FIXING ELEMENTS AND ACCESSORIES

Ø	Female fork with clips	Articulated self-lubricating fork	Fork with axially mounted articulated pin	Fork with angle mounted articulated pin	Floating joint	Centering adaptor ring	Rear female hinge with pin	Counter hinge 90° (CETOP)	Counter hinge 90°	Counter hinge 90° (CNOMO)	Narrow female hinge with pin
16						-	-	-	-	-	-
20	MF-15012	MF-17012	MF-22016	MF-23012	MF-24012	-	-	-	-	-	-
25	MF-15020	MF-17020	MF-22020	MF-23020	MF-24020	-	-	-	-	-	-
32	KF-15032	KF-17032	KF-22025	KF-23025	KF-24032	RSF-09032	KF-10032A	KF-19032CTA	KF-19032	KF-19032CN	KF-10032AS
40	KF-15032	KF-17032	KF-22025	KF-23025	KF-24032	RSF-09040	KF-10040A	KF-19040CTA	KF-19040	KF-19040050CN	KF-10040AS
50	KF-15040	KF-17040	KF-22040	KF-23040	KF-24040	RSF-09050	KF-10050A	KF-19050CTA	KF-19050	KF-19040050CN	KF-10050AS
63	KF-15040	KF-17040	KF-22040	KF-23040	KF-24040	RSF-09063	KF-10063A	KF-19063CTA	KF-19063	KF-19063080CN	KF-10063AS

Ø	Articulated counter hinge	Articulated rear male hinge	Rear male hinge	Front/rear flange	Angle bracket	Front/rear hinge	Hinge support	ISO Intermediate hinge	DF sensor and DHF covering strip	Cable clamping for DF sensor
16										
20	-	-	-	-	-	-	-	-		
25	-	-	-	-	-	-	-	-		
32	KF-19032SC	KF-11032S	KF-11032	KF-12032	KF-13032	KF-14032AP	KF-41032	KDF-14032		
40	KF-19040SC	KF-11040S	KF-11040	KF-12040	KF-13040	KF-14040AP	KF-41040050	KDF-14040		
50	KF-19050SC	KF-11050S	KF-11050	KF-12050	KF-13050	KF-14050AP	KF-41040050	KDF-14050		
63	KF-19063SC	KF-11063S	KF-11063	KF-12063	KF-13063	KF-14063AP	KF-41063080	KDF-14063		



Adjustable pneumatic cushioning

UNIVER Original since 1999

- No change in dimensions comparing to an equivalent cylinder without cushionings
- Standard supplied for all models

STRONG

Oversized guide and piston rods

ISO 15552

Interaxes, centering diameters and piston rods complying with ISO 15552 standards



RS

Ø 32 ÷ 100 mm



RS210

With anti-rotation guides Ø 32 ÷ 100 mm

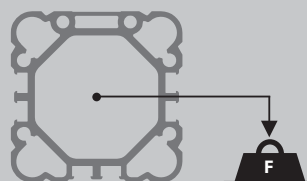


RQ

Ø 32 ÷ 63 mm



Non-rotating version (octagonal tube)
Max load (Nm)



Ø	Nm
32	2
40	3
50	5
63	8



Assembly Kit
available for all series




CHARACTERISTICS

Ambient temperature	-20 ÷ 80 °C
Fluid	filtered air, with or without lubrication
Working pressure	1,5 ÷ 10 bar
End-caps	die-cast aluminium
Barrel	anodized aluminium
Piston	aluminium
Guide slide	acetalic resin
Piston rod	chromium-plated steel, stainless steel upon request
Piston seal	NBR
Guide bush for piston rod	acetalic resin
Shock absorber seals	NBR
Cushionings	pneumatic adjustable (UNIVER Original standard supplied)
Magnet	standard supplied
Other versions available	tandem, two-position tandem, opposed tandem, with common piston rod (upon request)

CODIFICATION KEY

R	S	2	0	0	0	3	2	0	0	2	5	
1	2	3	4	5	6							

1 Series	2 Type	3 Version
RS = Ø 32÷100 mm - STRONG Compact Cylinders	1 = Stainless steel female piston rod 2 = Chromium-plated steel female piston rod 3 = Stainless steel male piston rod 4 = Chromium-plated steel male piston rod	For type 1 - 2 00 = D.A. Standard version 01 = D.A. Through piston rod 10 = D.A. Non-rotating guided piston rod (Ø32÷63) 11 = D.A. Non-rotating guided through piston rod (Ø32÷63) 20 = D.A. Long piston (Ø32÷63) 60 = S.A. Retracted piston rod 70 = S.A. Extended piston rod
		For type 3 - 4 00 = D.A. Standard version 01 = D.A. Through piston rod 20 = D.A. Long piston (Ø32÷63) 60 = S.A. Retracted piston rod 70 = S.A. Extended piston rod

4 Bore (mm)	5 Stroke (mm)	6 Option
032 = Ø32 040 = Ø40 050 = Ø50 063 = Ø63 080 = Ø80 100 = Ø100	Single acting 0005 - 0010 - 0015 - 0020 - 0025 Double acting 0005 - 0010 - 0015 - 0020 - 0025 0030 - 0040 - 0050 - 0060 - 0080 Max standard stroke 0080 (Ø32÷100)	Max stroke with long piston (upon request) 0800 (Ø32-40) 1000 (Ø50÷63) Max stroke with non-rotating guided piston rod (upon request) 0400 (Ø32-40) 0800 (Ø63) 0500 (Ø50)
		H = Hollow piston rod only for through piston rod versions without flange G = Preset for locking unit only for D.A. cylinders with chromium-plated steel piston rod C = With flange for versions: 100-101-120-160-170 200-201-220-260-270

For high temperature applications please contact our Sales Office

FIXING ELEMENTS AND ACCESSORIES

Ø	Female fork with clips	Articulated self-lubricating fork	Fork with axially mounted articulated pin	Fork with angle mounted articulated pin	Floating joint	Flange for female piston rod	Centering adaptor ring	Female rear hinge with pin	Counter hinge 90° (CETOP)	Counter hinge 90°	Counter hinge 90° (CNOMO)
32	KF-15032	KF-17032	KF-22025	KF-23025	KF-24032	RPF-28032	RSF-09032	KF-10032A	KF-19032CTA	KF-19032	KF-19032CN
40	KF-15040	KF-17040	KF-22040	KF-23040	KF-24040	RPF-28040	RSF-09040	KF-10040A	KF-19040CTA	KF-19040	KF-19040050CN
50	KF-15050	KF-17050	KF-22050	KF-23050	KF-24050	RPF-28050	RSF-09050	KF-10050A	KF-19050CTA	KF-19050	KF-19040050CN
63	KF-15050	KF-17050	KF-22050	KF-23050	KF-24050	RPF-28063	RSF-09063	KF-10063A	KF-19063CTA	KF-19063	KF-19063080CN
80	KF-15080	KF-17080	KF-22080	KF-23080	KF-24080	-	RSF-09080	KF-10080A	KF-19080CTA	KF-19080	KF-19063080CN
100	KF-15080	KF-17080	KF-22080	KF-23080	KF-24080	-	RSF-09100	KF-10100A	KF-19100CTA	KF-19100	KF-19100125CN

Ø	Narrow female hinge with pin	Articulated counter hinge	Articulated rear male hinge	Rear male hinge	Front/rear flange	Angle bracket	Front/rear hinge with floating pin	Hinge support	ISO Intermediate hinge	DF sensor and DHF covering strip	Cable clamping for DF sensor
32	KF-10032AS	KF-19032SC	KF-11032S	KF-11032	KF-12032	KF-13032	KF-14032AP	KF-41032	KDF-14032	DF DHF-0020100	DF-001
40	KF-10040AS	KF-19040SC	KF-11040S	KF-11040	KF-12040	KF-13040	KF-14040AP	KF-41040050	RPF-14040		
50	KF-10050AS	KF-19050SC	KF-11050S	KF-11050	KF-12050	KF-13050	KF-14050AP	KF-41040050	RPF-14050		
63	KF-10063AS	KF-19063SC	KF-11063S	KF-11063	KF-12063	KF-13063	KF-14063AP	KF-41063080	RPF-14063		
80	KF-10080AS	KF-19080SC	KF-11080S	KF-11080	KF-12080	KF-13080	KF-14080AP	KF-41063080	KDF-14080		
100	KF-10100AS	KF-19100SC	KF-11100S	KF-11100	KF-12100	KF-13100	KF-14100AP	KF-41100125	KDF-14100		

CHARACTERISTICS

Ambient temperature	-20 ÷ 80 °C
Fluid	filtered air, with or without lubrication
Working pressure	1,5 ÷ 10 bar
End-caps	die-cast aluminium
Barrel	anodized aluminium
Piston	aluminium
Guide slide	acetalic resin
Piston rod	chromium-plated steel, stainless steel upon request
Piston seal	NBR
Guide bush for piston rod	acetalic resin
Shock absorber seals	NBR
Cushionings	pneumatic adjustable (UNIVER Original standard supplied)
Magnet	standard supplied
Other available versions	tandem, two-position tandem, opposed tandem, with common piston rod (upon request)


CODIFICATION KEY

R	Q	2	0	0	0	3	2	0	0	2	5	
1	2	3	4		5			6				

1 Series RQ = Ø 32÷63 mm - STRONG Compact Cylinders octagonal tube 	2 Type 1 = Stainless steel female piston rod with flange 2 = Chromium-plated steel female piston rod with flange 3 = Stainless steel male piston rod 4 = Chromium-plated steel male piston rod	3 Version 00 = D.A. Standard version 01 = D.A. Through piston rod 20 = D.A. Long piston D.A. = Double acting
4 Bore (mm) 032 = Ø32 040 = Ø40 050 = Ø50 063 = Ø63	5 Stroke (mm) Double acting 0005 - 0010 - 0015 - 0020 - 0025 0030 - 0040 - 0050 - 0060 - 0080 Max standard stroke 0080 Max stroke with long piston (upon request) 0400 (Ø32-40) 1000 (Ø50-63)	6 Option H = Hollow piston rod only for through piston rod versions without flange G = Preset for locking unit only with chromium-plated steel piston rod

FIXING ELEMENTS AND ACCESSORIES

Ø	Female fork with clips	Articulated self-lubricating fork	Fork with axially mounted articulated pin	Fork with angle mounted articulated pin	Floating joint	Centering adaptor ring	Female rear hinge with pin	Counter hinge 90° (CETOP)	Counter hinge 90°	Counter hinge 90° (CNOMO)	Narrow female hinge with pin
32											
40	KF-15032	KF-17032	KF-22025	KF-23025	KF-24032	RSF-09032	KF-10032A	KF-19032CTA	KF-19032	KF-19032CN	KF-10032AS
50	KF-15040	KF-17040	KF-22040	KF-23040	KF-24040	RSF-09040	KF-10040A	KF-19040CTA	KF-19040	KF-19040050CN	KF-10040AS
63	KF-15050	KF-17050	KF-22050	KF-23050	KF-24050	RSF-09050	KF-10050A	KF-19050CTA	KF-19050	KF-19040050CN	KF-10050AS
	KF-15050	KF-17050	KF-22050	KF-23050	KF-24050	RSF-09063	KF-10063A	KF-19063CTA	KF-19063	KF-19063080CN	KF-10063AS

Ø	Articulated counter hinge	Articulated rear male hinge	Rear male hinge	Front, rear flange	Angle bracket	Front / rear hinge	Hinge support	ISO Intermediate hinge	DF sensor and DHF covering strip	Cable clamping for DF sensor
32										
40	KF-19032SC	KF-11032S	KF-11032	KF-12032	KF-13032	KF-14032AP	KF-41032	KDF-14032	DHF-0020100	DF-001
50	KF-19040SC	KF-11040S	KF-11040	KF-12040	KF-13040	KF-14040AP	KF-41040050	RPF-14040		
63	KF-19050SC	KF-11050S	KF-11050	KF-12050	KF-13050	KF-14050AP	KF-41040050	RPF-14050		
	KF-19063SC	KF-11063S	KF-11063	KF-12063	KF-13063	KF-14063AP	KF-41063080	RPF-14063		

COMPACT

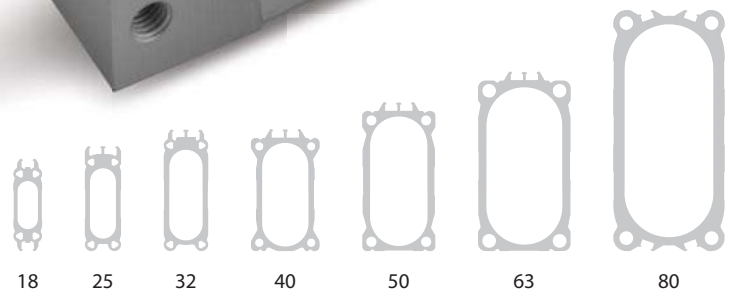
Up to **40%** width reduction if compared to standard cylinders

ANTI-ROTATION

Piston rod max rotation from 0,3° to 0,9°

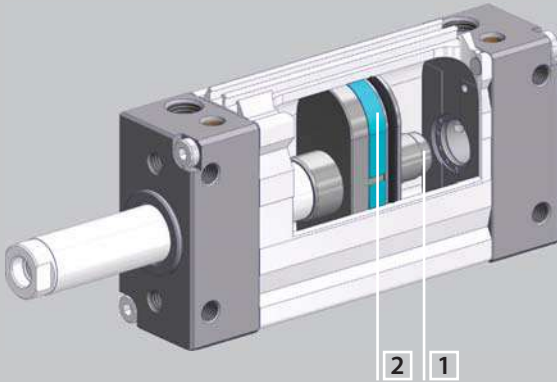
CUSHIONING

Standard supplied $\varnothing 18 \div 80$ mm (adjustable pneumatic cushionings)



OV

$\varnothing 18 \div 80$ mm



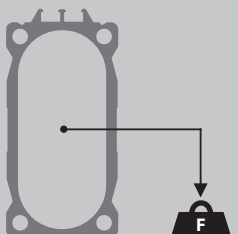
1 Adjustable pneumatic cushioning

- Standard supplied
- No variation in dimensions comparing to an equivalent cylinder without cushionings

2 Oversized piston guide and UNIVER original seal

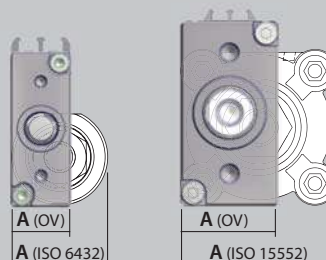
- Suitable for heavy loads (F)
- Piston rod rotation highly reduced

Max applicable torque (Nm) and related Max rotation



\varnothing	F (Nm)	Degrees
18	0,80	0,90
25	1,00	0,80
32	1,40	0,60
40	1,70	0,40
50	2,00	0,35
63	2,30	0,30
80	2,60	0,30

Comparison of A dimension: OV cylinder vs ISO standard cylinder



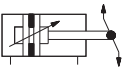
\varnothing	A (OV)	A (ISO)	Reduction
18	16	46,5	-42%
25	20	52	-35%
32	24,5	64,5	-45%
40	38	76,5	-30%
50	40	95	-40%
63	50	114	-35%
80	60	140	-38%

CHARACTERISTICS	
Ambient temperature	-20 ÷ 80 °C
Fluid	filtered air, with or without lubrication
Working pressure	1,5 ÷ 10 bar
End-caps	anodized aluminium
Barrel	anodized aluminium
Piston	aluminium
Guide slide	technopolymer
Piston rod	stainless steel (Ø18-25), chromium-plated steel (Ø32÷80)
Piston seal	NBR
Guide bush for piston rod	standard supplied
Piston rod scraper seals	polyurethane
Cushionings	pneumatic adjustable (standard supplied)
Magnet	standard supplied



CODIFICATION KEY

O	V	2	0	0	0	3	2	0	0	5	0
1	2	3	4	5							

1 Series	2 Type	3 Version
OV = Ø 18÷80 mm - Oval Cylinders 	1 = Stainless steel female piston rod (Ø18÷80) 2 = Chromium-plated steel female piston rod (Ø32÷80) 3 = Stainless steel male piston rod (Ø18÷80) 4 = Chromium-plated steel male piston rod (Ø32÷80)	00 = D.A. Standard version 01 = D.A. Through piston rod 02 = D.A. Hollow through piston rod

D.A. = Double acting

4 Bore (mm)	5 Stroke (mm)
018 = Ø18 050 = Ø50 025 = Ø25 063 = Ø63 032 = Ø32 080 = Ø80 040 = Ø40	0010 - 0025 - 0040 - 0050 - 0080 - 0100 - 0125 - 0160 - 0200 (Ø18-25) 0010 - 0025 - 0040 - 0050 - 0080 - 0100 - 0125 - 0160 - 0200 - 0250 - 0320 (Ø 32÷80)

Theoretical forces (N) developed at working pressure (bar)

Ø	Working pressure					Working pressure					Cushioning length
	bar					bar					
	2	4	6	8	10	2	4	6	8	10	
18	54	108	162	216	270	41	82	122	163	204	8
25	98	196	295	393	491	82	165	247	330	412	10
32	161	322	483	643	804	138	276	415	553	691	10
40	251	502	754	1005	1256	221	422	633	844	1055	14
50	393	785	1178	1570	1963	330	660	990	1320	1650	Front 11/Back 14
63	623	1246	1870	2493	3116	560	1120	1682	2240	2800	Front 11/Back 14
80	1005	2010	3015	4019	5024	942	1884	2826	3770	4711	Front 20/Back 27

FIXING ELEMENTS AND ACCESSORIES

Ø	Female fork with clips	Articulated self-lubricating fork	Fork with axially mounted articulated pin	Fork with angle mounted articulated pin	Floating joint	Angle bracket	Male hinge	Flange	DF sensor and DHF covering strip	Cable clamping for DF sensor
18										
25	MF-15020	MF-17020	MF-22020	MF-23020	KF-24020	OVF-13018	OVF-11018	OVF-12018		
32	KF-15032	KF-17032	KF-22025	KF-23025	KF-24032	OVF-13025	OVF-11025	OVF-12025		
40	KF-15032	KF-17032	KF-22025	KF-23025	KF-24032	OVF-13032	OVF-11032	OVF-12032		
50	KF-15040	KF-17040	KF-22040	KF-23040	KF-24040	OVF-13040	OVF-11040	OVF-12040		
63	KF-15050	KF-17050	KF-22050	KF-23050	KF-24050	OVF-13050	OVF-11050	OVF-12050		
80	KF-15050	KF-17050	KF-22050	KF-23050	KF-24050	OVF-13063	OVF-11063	OVF-12063		
						OVF-13080	OVF-11080	OVF-12080	DF DHF-0020100	DF-001

1
CHARACTERISTICS

Ambient temperature	-20 ÷ 80 °C
Fluid	filtered air, with or without lubrication
Working pressure	1,5 ÷ 10 bar

End-caps	aluminium
Barrel	aluminium
Piston	aluminium
Guide slide	technopolymer
Piston rod	stainless steel
Piston seal	NBR
Guide bush for piston rod	standard supplied
Piston rod scraper seal	polyurethane
Shock absorber seals	NBR (standard supplied)
Other versions available	tandem, two-position tandem, multiple position tandem


CODIFICATION KEY

W	1	0	0	0	3	2	0	0	5	0		
1	2	3	4	5	6	7						

1 Series	2 Type	3 Version
----------	--------	-----------

W = Ø 12÷100 mm Short Stroke Cylinders	1 = Stainless steel piston rod 7 = Stainless steel piston rod with male rear hinge, versions 00 - 10 - 60 - 70 (except for bore Ø12)	00 = D.A. Standard version 01 = D.A. Through piston rod 10 = D.A. Non-rotating piston rod (except for Ø 12) 11 = D.A. Non-rotating through piston rod (except for Ø 12) 31 = D.A. Hollow through piston rod (except for Ø 12-16) 60 = S.A. Retracted piston rod 70 = S.A. Extended piston rod
--	---	---

D.A. = Double acting
S.A. = Single acting

4 Bore (mm)	5 Stroke (mm)	6 Option	7 Magnetic
-------------	---------------	----------	------------

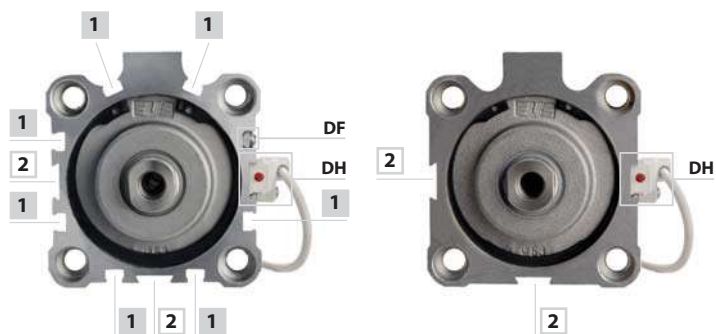
012 = Ø12 040 = Ø40 016 = Ø16 050 = Ø50 020 = Ø20 063 = Ø63 025 = Ø25 080 = Ø80 032 = Ø32 100 = Ø100	Single acting 0005 - 0010 (Ø12÷25) 0005 - 0010 - 0025 (Ø32÷100) Double acting 0005 - 0010 - 0020 - 0025 0030 - 0040 - 0050 (Ø12-16) 0005 - 0010 - 0020 - 0025 0030 - 0040 - 0050 - 0075 (Ø20÷100)	S = Safety distance (only for versions 10 and 11)	M = Magnetic version (except for Ø 12)
--	--	---	--

FIXING ELEMENTS AND ACCESSORIES

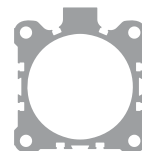
Ø	Nipple	DF sensor and DHF covering strip	Cable clamping for DF sensor	DH sensor
12	WF-50012	DF DHF-0020100	DF-001	DH
16	WF-50012			
20	WF-50020			
25	WF-50020			
32	WF-50032			
40	WF-50040			
50	WF-50050			
63	WF-50063			
80	WF-50080			
100	WF-50080			

New tube

Traditional tube



- 1 Groove for DF series recessed sensor
- 2 Groove for DH series traditional sensor



Ø 12 mm

Ø 16-20 mm

Ø 25-32 mm

Ø 40 mm

Ø 50-63-80-100 mm

CHARACTERISTICS

Ambient temperature	-20 ÷ 80 °C
Fluid	filtered air, with or without lubrication
Working pressure	1,5 ÷ 10 bar

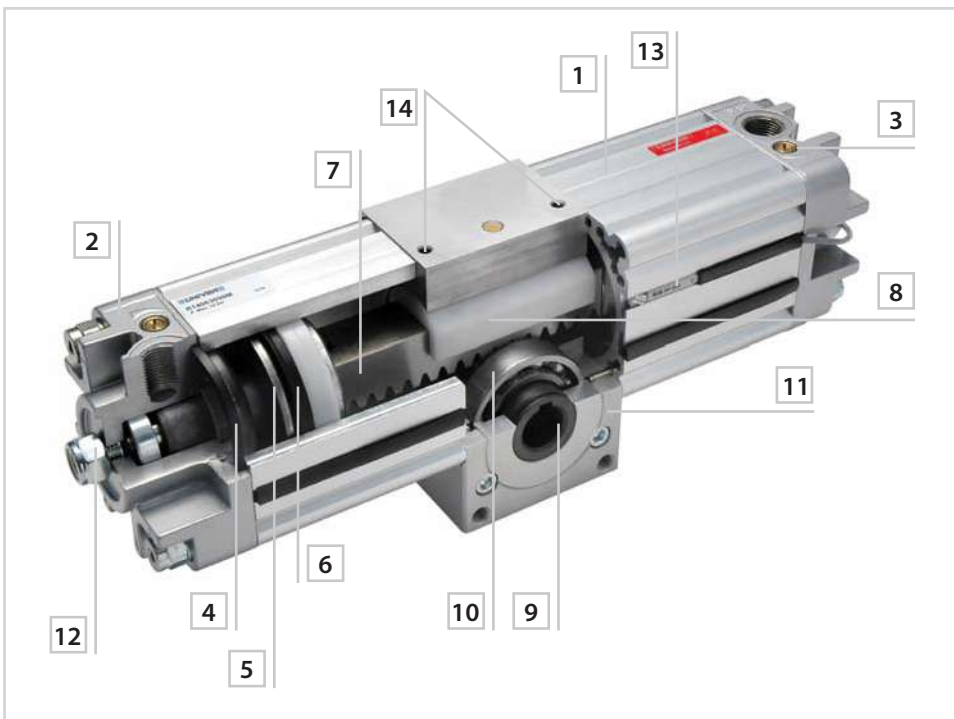
End-caps	aluminium
Barrel	aluminium
Piston	die-cast aluminium
Guide slide	acetalic resin
Rack	stainless steel
Piston seal	NBR
Pinion	nitrided steel
Shock absorber seals	NBR
Cushionings	pneumatic adjustable (standard supplied)



CODIFICATION KEY

R	1	1	0	3	2	1	8	0	
1	2	3	4	5					

1 Series	2 Type	3 Bore (mm)	4 Angle of rotation	5 Magnetic
R = Ø 32÷125 mm Pneumatic rotary actuators	11 = Male pinion without adjustment (degree of accuracy ± 3°) 12 = Male pinion with adjustment ± 5° 13 = Female pinion without adjustment (degree of accuracy ± 3°) 14 = Female pinion with adjustment ± 5°	032 = Ø32 040 = Ø40 050 = Ø50 063 = Ø63 080 = Ø80 100 = Ø100 125 = Ø125	090 = 90° 180 = 180° 270 = 270° 360 = 360°	M = Magnetic version



- | | |
|--|---|
| 1. Cylinder barrel: extruded profile in aluminium | 8. Guide slide for rack with self-adjusting backlash recovery |
| 2. Die-cast end-caps in aluminium | 9. Nitrided steel pinion |
| 3. Pneumatic adjustable cushionings | 10. Ball bearings for pinion support |
| 4. Shock absorber seals | 11. Anodized aluminium central body |
| 5. Die-cast piston in aluminium alloy and acetalic resin guide slide | 12. Adjustment screws: angle of rotation ±2,5° |
| 6. Piston seals in nitrile rubber compound | 13. DF series magnetic sensor |
| 7. Standards-based steel square rack | 14. Screws for backlash recovery |

ACCESSORIES

Ø	DF sensor and DHF covering strip	Cable clamping for DF sensor
32 40 50 63 80 100 125	DF DHF-0020100	DF-001

1
CHARACTERISTICS

Ambient temperature	-20° ÷ 80 °C
Fluid	filtered air, with or without lubrication, neutral gases
Working pressure	4 ÷ 8 bar (single acting) 2 ÷ 8 bar (double acting)
Connections	NAMUR interface (G1/4)
Rotation	0-90°±3° (external adjustment)
Max pressure	10 bar
End-caps	die-cast aluminium
Piston	die-cast aluminium
Guide slide	acetalic resin
Seals	NBR
Body	hard anodized aluminium extrusion
Pinion	nickel-plated steel
Screws and nuts	stainless steel

Connections: bottom hole for ball valve installation in compliance with ISO 5211/DIN 3337 standards. Solenoid valve interface, shaft top-end and top hole for accessory fixing in compliance with VDI/VDE 3845 NAMUR standards.


CODIFICATION KEY

Y	R	2	0	1	D	A	0
		1	2				3

1 Series	2 Size (mm)	3 Version
YR2 = Rotary Actuators for Process Automation	00 = 32 (DA0 only) 01 = 50 2A = 63 (F04) 2B = 63 (F05) 03 = 75 35 = 85 04 = 100	45 = 115 05 = 125 55 = 145 06 = 160 08 = 200 10 = 250
		DA0 = Double acting S12 = Single acting - 12 springs standard (different number of springs upon request)

Torque - double acting version (P = 6 bar)

Part No.	Torque (Nm)
YR200DA0	7,3
YR201DA0	17,7
YR22ADA0-YR22BDA0	28,2
YR203DA0	60
YR235DA0	102
YR204DA0	142
YR245DA0	261,6
YR205DA0	333
YR255DA0	473
YR206DA0	680
YR208DA0	1276
YR210DA0	3234

Torque - single acting version (P = 6 bar)

Part No.	Torque (Nm)	
	0°	90°
YR201S12	10,5	7,2
YR22AS12-YR22BS12	16,8	11,4
YR203S12	36	24
YR235S12	64	39
YR204S12	87	56
YR245S12	159,6	101,6
YR205S12	203	130
YR255S12	303	173
YR206S12	429	260
YR208S12	796	520
YR210S12	1909	1254

■ YR series ball valve



■ AC-N series NAMUR valves



■ AC-N series valves with actuator



YR3



Ambient temperature: 0 ÷ 50 °C
Working pressure: 1,5 ÷ 7 bar
Rotation angle: 0° ÷ 180°
Version upon request: with shock absorbers Ø 15 ÷ 63
 (add suffix D to part no. e.g. YR3010D)

Part. No	Ø	Torque (Nm)*	Kinetic energy (J)	Sensor
YR3003	10	0,3	0,002	DF-T
YR3007	12	0,6	0,006	
YR3010	15	1,5	0,006	
YR3020	18	2,2	0,025	
YR3030	20	3,2	0,048	
YR3050	25	5,5	0,080	
YR3070	28	7,5	0,24	
YR3100	32	9,8	0,32	
YR3200	40	19	0,56	
YR3300	50	31	1	
YR3500	63	45	1,5	

* = Theoretical torque at 5 bar

Examples of CYLINDER - VALVE assembly

- **RV - STRONG cylinder with integrated VDMA valve**
 STRONG cylinder with integrated 5/2-5/3 VDMA solenoid valve, side 18 or 26 mm.
 Supply and exhaust occur directly from the connection plate between valve and cylinder and exhausts are adjustable.
 Electrical connection M12 can be operated also from a PLC.



- **RW - Telescopic cylinder with integrated VDMA valve**
 Telescopic cylinder with integrated 5/2-5/3 VDMA solenoid valve, side 18 or 26 mm.
 Supply and exhaust occur directly from the connection plate between valve and cylinder and exhausts are adjustable.
 Electrical connection M12 can be operated also from a PLC.



- **KD series ISO 15552 cylinder with integrated valve**
 Valve mounting by means of a proper plate embedded in one of tube sensor grooves.



- **RS series STRONG cylinder with integrated valve**
 Valve mounting by means of a proper plate embedded in one of tube sensor grooves.



Plate for mounting valve on sensor groove

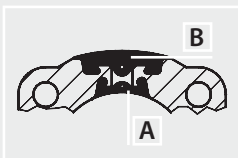


DF-003 (M3)
 DF-004 (M4)

S1-S5-VL1 | Rodless Cylinders



UNIVER Original since 1988



A - Internal strip (seal)
 B - External strip (protection) made of reinforced elastomer with Kevlar fiber



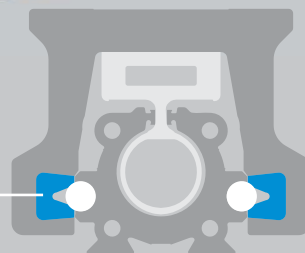
S1

Ø 16 ÷ 50 mm - Standard version



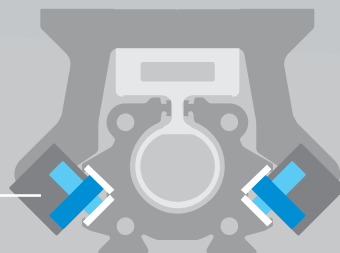
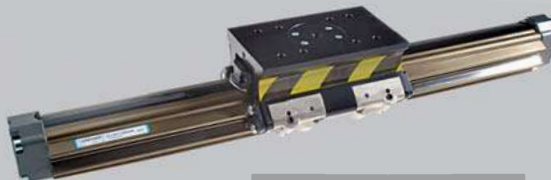
S5

Ø 25 ÷ 50 mm - Version with integrated guides
 Technopolymer sliding guide



VL1

Ø 25 ÷ 50 mm - Version with 90° integrated guides
 Sliding on ball bearings



KIT Assembly Kit
 available for all series



CHARACTERISTICS	
Ambient temperature	-20 ÷ 80 °C
Fluid	filtered air, with or without lubrication
Working pressure	3 ÷ 10 bar
End-caps	die-cast light alloy
Barrel	anodized aluminium
Piston	aluminium
Guide slide	acetalic resin
Piston seal	NBR
Shock absorber seals	mechanical
Cushionings	pneumatic adjustable (standard supplied)
Magnet	upon request

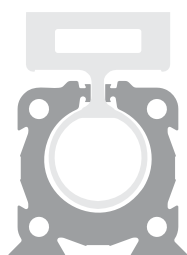


CODIFICATION KEY

S	1	0	1	1	2	5	0	8	5	0	
1	2	3	4	5	6	7					

1 Series	2 Carriage type	3 Left end-cap supply port
S1 = Ø 16÷50 mm - Rodless Cylinders standard version	0 = Standard carriage 2 = Medium carriage (except for Ø16) 3 = Long carriage (except for Ø16)	0 = No supply port (both chambers are supplied from the right end-cap) 1 = Side supply port (except for Ø16) 2 = Bottom supply port (except for Ø16) 3 = Rear supply port (except for Ø16)

4 Right end-cap supply port	5 Bore (mm)	6 Stroke (mm)	7 Magnetic
1 = Side supply port (except for Ø16) 2 = Bottom supply port (except for Ø16) 3 = Rear supply port (except for Ø16) 4 = Rear supply ports for both chambers on the right end-cap 5 = Side supply ports for both chambers on the right end-cap (only for Ø16)	16 = Ø18 25 = Ø25 32 = Ø32 40 = Ø40 50 = Ø50	Up to 5000 (Ø 16) Up to 6000 (Ø 25÷50)	M = Magnetic version standard supplied (Ø 16) upon request (Ø 25÷50)



S1

- Extruded aluminium profile Ø 16 ÷ 50 mm
- Stroke up to 6 m
- Different supply port configurations available
- Different carriage types
- High translation speed 1 ÷ 3 m/s

FIXING ELEMENTS AND ACCESSORIES

Ø	Bracket	Angle bracket	Fixing plate	Oscillating bracket	Female threaded connection	Male threaded pin	Female connection without thread	DF sensor and DHF covering strip	Cable clamping for DF sensor	DH sensor	Bracket for DH sensor
16		-						DF	DF-001	-	-
25	-	SF-13025	SF-12025	SF-24025	SF-26025	SF-27025	SF-28025	-	-	DH	DH-S25
32	-	SF-13032	SF-12032	SF-24032	SF-26032	SF-27032	SF-28032	-	-		DH-S32
40	SF-13040	-	SF-12040	SF-24032	SF-26032	SF-27032	SF-28032	-	-		DH-S40
50	SF-13050	-	SF-12050	-	-	-	-	-	-	-	DH-S50

CHARACTERISTICS

Ambient temperature	-20 ÷ 80 °C
Fluid	filtered air, with or without lubrication
Working pressure	3 ÷ 10 bar

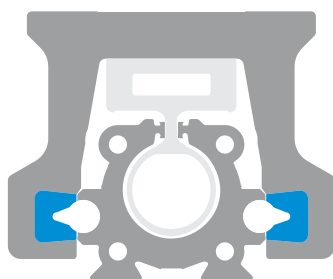
End-caps	die-cast light alloy
Barrel	anodized aluminium
Piston	aluminium
Guide slide	acetalic resin
Piston seal	NBR
Shock absorber seals	mechanical
Cushionings	pneumatic adjustable (standard supplied)


CODIFICATION KEY

S	5	0	1	1	2	5	0	8	5	0
1	2	3	4	5	6					

1 Series S5 = Ø 25÷50 mm - Rodless Cylinders with integrated guides Technopolymer sliding guide	2 Carriage type 0 = Standard carriage (except Ø 40-50) 2 = Medium carriage 3 = Long carriage	3 Left end-cap supply port 0 = No supply port (both chambers are supplied from the right end-cap) 1 = Side supply port 2 = Bottom supply port 3 = Rear supply port
---	--	---

4 Right end-cap supply port 1 = Side supply port 2 = Bottom supply port 3 = Rear supply port 4 = Rear supply ports for both chambers on the right end-cap	5 Bore (mm) 25 = Ø25 32 = Ø32 40 = Ø40 50 = Ø50	6 Stroke (mm) Up to 6000
--	--	---


S5

- Extruded aluminium profile Ø 25 ÷ 50 mm
- Stroke up to 6 m
- Flexible guide system
- Sliding of the carriage with plastic slide on steel shafts
- Translation speed 0,2 ÷ 1,5 m/sec.
- Version with locking unit available

FIXING ELEMENTS

Ø	Bracket	Angle bracket	Fixing plate
25		SF-13025	SF-12025
32		SF-13032	SF-12032
40	SF-13040	-	SF-12040
50	SF-13050	-	SF-12050



CHARACTERISTICS

Ambient temperature	-20 ÷ 80 °C
Fluid	filtered air, with or without lubrication
Working pressure	3 ÷ 10 bar

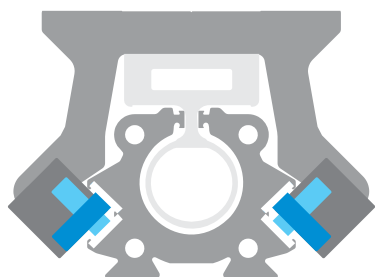
End-caps	die-cast light alloy
Barrel	anodized aluminium
Piston	aluminium
Guide slide	acetalic resin
Piston seals	NBR
Shock absorber seals	mechanical
Cushionings	pneumatic adjustable (standard supplied)


CODIFICATION KEY

V	L	1	2	2	1	1	3	2	0	8	5	0
		1	2	3	4	5	6				7	

1 Series VL1 = Ø 25÷50 mm - Rodless Cylinders with 90° integrated guides Sliding on ball bearings	2 Carriage type 2 = Medium carriage 3 = Long carriage	3 No. of ball bearing pairs standard supplied Medium carriage 2 = Ø 25÷40 3 = Ø 50 Long carriage 3 = Ø 25÷40 4 = Ø 50
---	--	--

4 Left end-cap supply port 0 = No supply port (both chambers are supplied from the right end-cap) 1 = Side supply port 2 = Bottom supply port 3 = Rear supply port	5 Right end-cap supply port 1 = Side supply port 2 = Bottom supply port 3 = Rear supply port 4 = Rear supply ports for both chambers on the right end-cap	6 Bore (mm) 25 = Ø25 32 = Ø32 40 = Ø40 50 = Ø50	7 Stroke (mm) Up to 6000
---	--	--	---


VL1

- Extruded aluminium profile Ø 25 ÷ 50 mm
- Stroke up to 6 m
- Heavy duty precision series
- Rigid guide system
- Sliding of the carriage on ball bearings
- Translation speed 0,2 ÷ 2 m/sec.
- Version with locking unit available

FIXING ELEMENTS

Ø	Bracket	Angle bracket	Fixing plate
25	-	SF-13025	SF-12025
32	-	SF-13032	SF-12032
40	SF-13040	-	SF-12040
50	SF-13050	-	SF-12050



J Slide Units

STRONG

Extruded aluminium profile structure
UNIVER Original

STURDY

Oversized hollow guiding shafts
made of chromium-plated steel

SMOOTH SLIDING

Self-lubricating guiding bushes
made of special steel

STANDARD

Wide range of standard solutions
for any application requirement



J1

ISO 6432 Cylinders



ISO 15552 Cylinders



J3

Rodless Cylinders



J64RS

STRONG Cylinders



J64RT2

Telescopic Cylinders



Assembly Kit
available for all series



CHARACTERISTICS

Ambient temperature	-20 ÷ 80 °C
Fluid	filtered air, with or without lubrication
Working pressure	2 ÷ 10 bar

Barrel	extruded anodized aluminium
Guide bush for piston rod	special steel
Shafts	chromium-plated steel
Shaft scraper seals	polyurethane
Flange	steel



Slide Units for M, KE/K, KD series cylinders

■ J1



CODIFICATION KEY

J	1	0	A	5	5	0	0	5	0	A
1	2	3	4	5	6	7				

1 Series	2 Type	3 Accessories
-----------------	---------------	----------------------

J = Slide Unit

- 10 = Protruding shafts and short housing (recommended for strokes up to 50 mm)
- 11 = Protruding shafts and medium housing
- 12 = Protruding shafts and long housing
- 14 = Fully protected cylinder
- 16 = Central mounting (semi-external cylinder)
- 17 = Central mounting (fully protected cylinder)
- 18 = Medium moving housing (external cylinder)
- 19 = Long moving housing (external cylinder)

A = Shaft scrapers standard supplied

4 Slide unit size	5 Cylinder bore (mm)	6 Cylinder stroke (mm)	7 Cylinder option
--------------------------	-----------------------------	-------------------------------	--------------------------

- 0 = 16 for Ø16 cylinders
- 2 = 25 for Ø25 cylinders
- 3 = 32 for Ø32 cylinders
- 4 = 40 for Ø40 cylinders
- 5 = 50 for Ø50 cylinders
- 6 = 63 for Ø63 cylinders
- 7 = 80 for Ø80 cylinders
- 8 = 100 for Ø100 cylinders

- 0 = Ø16
- 2 = Ø25
- 3 = Ø32
- 4 = Ø40
- 5 = Ø50
- 6 = Ø63
- 7 = Ø80
- 8 = Ø100

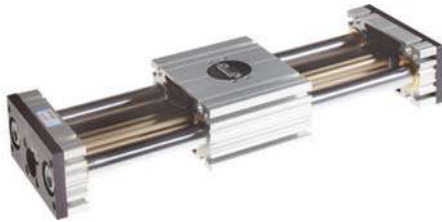
- M
- 0025 - 0030 - 0040 - 0050 - 0075
- 0100 - 0125 - 0150 - 0160 - 0175
- 0200 - 0250 - 0300 - 0400 - 0500
- KD - KE/K
- 0025 - 0050 - 0075 - 0080 - 0100
- 0125 - 0150 - 0160 - 0175 - 0200
- 0250 - 0300 - 0320 - 0400 - 0450
- 0500 - 0600 - 0700 - 0800 - 0900
- 1000

- A = M150 series Ø16÷25 microcylinders
K200 series Ø32÷100 cylinders
- B = M250 series Ø16÷25 microcylinders with locking unit
K200 series Ø32÷100 cylinders with locking unit (only for J12, J14, J16, J17)
- C = KE200 series Ø 32÷100 cylinders
- D = KE200 series Ø 32÷100 cylinders with locking unit (only for J12, J14, J16, J17)
- E = KD200 series Ø32÷100 cylinders
- F = KD200 series Ø32÷100 cylinders with locking unit (only for J12, J14 and J16)

Slide units are supplied with integrated cylinder

1 Slide Units for S1 series rodless cylinders

■ J3



CODIFICATION KEY

J	3	0	A	5	3	0	1	0	0	A
1	2	3	4	5	6		7			

1 Series J = Slide Unit	2 Type 30 = Fully protected cylinder (2 bearings - standard carriage) 31 = Fully protected cylinder (2 bearings - long carriage)	3 Accessories A = Shaft scrapers standard supplied	
4 Slide unit size 4 = 40 for Ø25 cylinders 5 = 50 for Ø32 cylinders 6 = 63 for Ø40 cylinders 7 = 80 for Ø50 cylinders	5 Cylinder bore (mm) 2 = Ø25 3 = Ø32 4 = Ø40 5 = Ø50	6 Slide unit stroke (mm) Up to 0800	7 Supply port option A = Supply ports on both end-caps B = Supply ports on the right end-cap only

Slide Units for RS series STRONG compact cylinders

■ J64RS



CODIFICATION KEY

J	6	4	R	S	3	3	0	0	5	0	B
1	2	3	4	5	6		7				

1 Series J = Slide Unit - Shaft scrapers standard supplied	2 Slide unit type 64 = Fully protected cylinder (stroke longer than 50 mm) 65 = Fully protected cylinder, through opening 66 = Fully protected cylinder, through opening, two plates 67 = Fully protected cylinder, two plates (stroke longer than 50 mm)	3 Cylinder type RS = STRONG cylinder (RS22J... series) with long piston and tube with sensor grooves on the same side as supply ports to allow mounting of magnetic sensors	
4 Slide unit size 3 = 32 for Ø32 cylinders 4 = 40 for Ø40 cylinders 5 = 50 for Ø50 cylinders 6 = 63 for Ø63 cylinders	5 Cylinder bore (mm) 3 = Ø32 4 = Ø40 5 = Ø50 6 = Ø63	6 Slide unit stroke (mm) 0015 ÷ 0800	7 Cylinder option A = Cylinder with long piston B = Cylinder with long piston and locking unit

Slide units are supplied with integrated cylinder

Slide Units for RT2 series telescopic cylinders

■ J64RT2



CODIFICATION KEY

J	6	4	R	T	2	4	4	0	8	0	0	A
1	2	3	4	5	6	7						

1 Series J = Slide Unit - Shaft scrapers standard supplied	2 Slide unit type 64 = Fully protected telescopic cylinder	3 Cylinder type RT2 = 2 stage telescopic cylinders
--	--	--

4 Slide unit size 3 = 32 for Ø32 cylinders 4 = 40 for Ø40 cylinders 5 = 50 for Ø50 cylinders 6 = 63 for Ø63 cylinders	5 Cylinder bore (mm) 3 = Ø32 4 = Ø40 5 = Ø50 6 = Ø63	6 Slide unit stroke (mm) Standard stroke 0120 - 0160 - 0180 - 0200 - 0300 - 0400 - 0500 0600 - 0700 - 0800 - 0900 - 1000 - 1100 - 1200 Min - Max stroke 0160 ÷ 0400 (Ø32) 0160 ÷ 0600 (Ø40) 0120 ÷ 0900 (Ø50) 0120 ÷ 1200 (Ø63)	7 Cylinder option A = 2 stage telescopic cylinders
--	---	--	--

Slide Units for RP series compact cylinders

■ J65



CODIFICATION KEY

J	6	5	R	P	2	2	0	0	5	0	A
1	2	3	4	5	6	7					

1 Series J = Slide Unit - Shaft scrapers standard supplied	2 Slide unit type 65 = Fully protected cylinder, through opening	3 Cylinder type RP = UNITOP Ø25 mm compact cylinder
--	--	---

4 Slide unit size 2 = 25 for Ø25 cylinders	5 Cylinder bore (mm) 2 = Ø25	6 Slide unit stroke (mm) 0050 ÷ 0200	7 Cylinder option A = Cylinder with long piston
--	--	--	---

Slide units are supplied with integrated cylinder

1

CHARACTERISTICS

Ambient temperature	-5 ÷ +60 °C
Fluid	filtered air, with or without lubrication
Working pressure	1 ÷ 10 bar
Body	aluminium alloy
Shafts	chromium-plated steel (JLS) hardened and chromium-plated steel (JLV)
Piston	aluminium alloy
Piston rod	chromium-plated stainless steel AISI 303 (Ø12-16-20) chromium-plated steel C45 (Ø25-32-40-50-63)
Guide bearing	bearings (JLS) ball bushing (JLV)
Piston seal	NBR
Cushion seals	NBR
Magnet	standard supplied
Flange	steel



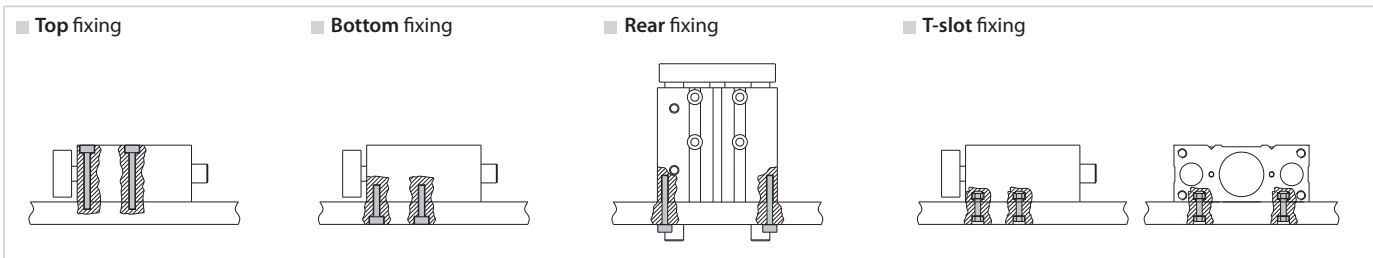
CODIFICATION KEY

J	L	S	0	1	2	0	0	3	0	
1	2	3	4							

1 Series JL = Guided Compact Cylinders	2 Guide bearing S = Bearings V = Ball bushing	3 Bore (mm) 012 = Ø12 032 = Ø32 016 = Ø16 040 = Ø40 020 = Ø20 050 = Ø50 025 = Ø25 063 = Ø63
--	--	--

4 Stroke (mm)	0010 = 10 0075 = 75 0250 = 250 0020 = 20 0100 = 100 0300 = 300 0025 = 25 0125 = 125 0350 = 350 0030 = 30 0150 = 150 0400 = 400 0040 = 40 0175 = 175 0050 = 50 0200 = 200	<table border="1"> <thead> <tr> <th colspan="2">Strokes (mm)</th> </tr> <tr> <th>Ø</th> <th>10 20 25 30 40 50 75 100 125 150 175 200 250 300 350 400</th> </tr> </thead> <tbody> <tr> <td>12</td> <td>—</td> </tr> <tr> <td>16</td> <td>—</td> </tr> <tr> <td>20</td> <td>—</td> </tr> <tr> <td>25</td> <td>—</td> </tr> <tr> <td>32</td> <td>—</td> </tr> <tr> <td>40</td> <td>—</td> </tr> <tr> <td>50</td> <td>—</td> </tr> <tr> <td>63</td> <td>—</td> </tr> </tbody> </table>	Strokes (mm)		Ø	10 20 25 30 40 50 75 100 125 150 175 200 250 300 350 400	12	—	16	—	20	—	25	—	32	—	40	—	50	—	63	—
Strokes (mm)																						
Ø	10 20 25 30 40 50 75 100 125 150 175 200 250 300 350 400																					
12	—																					
16	—																					
20	—																					
25	—																					
32	—																					
40	—																					
50	—																					
63	—																					

Fixing schemes

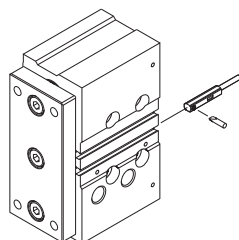


DF-R magnetic sensor

- ELECTROMECHANICAL**
DF-R200L02
DF-R200M08
- ELECTRONIC (PNP)**
DF-R700L02
DF-R700M08

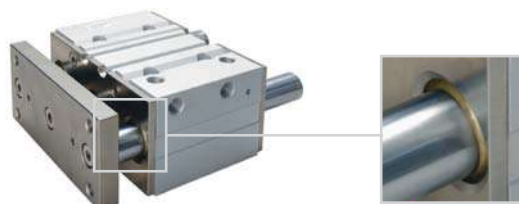


Mounting scheme



Upon request

- Version with metallic piston rod scraper



Ø 6 ÷ 32 mm - Twin Rod Guided Cylinder
JT


Ambient temperature: -5 ÷ 60 °C
 Stroke adjustment: 0 ÷ 5 mm

Part No.	Ø	Working pressure (bar)	Theoretical thrust force (N)*		Standard stroke (mm)	Max stroke (mm)	Sensor
			Thrust	Traction			
JTS006 JTV006	6	1,5 - 7	28	15,5	10-20-30	50	DF-R200
JTS012 JTV012	12	1 - 7	113	84	10-15-20-25-30 35-40-45-50-60-70	70	
JTS016 JTV016	16	1 - 7	200	150	10-15-20-25 30-35-40-45 50-60-70-75 80-90-100	120	
JTS020 JTV020	20	0,5 - 7	314	236		130	
JTS025 JTV025	25	0,5 - 7	490	378		150	
JTS032 JTV032	32	0,5 - 7	802	603		150	

S = Bearings
 V = Ball bushing

* = Theoretical thrust force at 5 bar

Ø 6 ÷ 20 mm - Pneumatic Mini Slide Unit
JX1


Ambient temperature: -5 ÷ 60 °C
 Embodied linear guide

Part No.	Ø	Working pressure (bar)	Theoretical thrust force (N)*		Standard stroke (mm)	Sensor
			Thrust	Traction		
JX1006	6	1,2 - 7	14,2	10,6	5-10-15-20-25 30-40-50-60	DF-R200
JX1010	10	0,6 - 7	39,3	33		
JX1016	16	0,6 - 7	101	86		
JX1020	20	0,5 - 7	157	132		

* = Theoretical thrust force at 5 bar

Ø 6 ÷ 25 mm - Slide Table Actuator
JX2


Ambient temperature: 0 ÷ 60 °C

Versions upon request:

with stroke adjusting screw (add suffix R to part no. e.g. JX2008R)
 with hydraulic shock absorbers Ø 8 ÷ 25 (add suffix D to part no. e.g. JX2008D)

Part No.	Ø	Working pressure (bar)	Theoretical thrust force (N)*		Standard stroke (mm)	Sensor
			Thrust	Traction		
JX2006	6	1,5 ÷ 7	25	20	10-20-30-40-50	DF-T200
JX2008	8		51	38	10-20-30-40-50-75	
JX2012	12		113	85	10-20-30-40-50-75-100	
JX2016	16		201	151	10-20-30-40-50-75-100-125	
JX2020	20		314	236	10-20-30-40-50-75-100-125-150	
JX2025	25		491	380	10-20-30-40-50-75-100-125-150	

* = Theoretical thrust force at 5 bar

Self-compensating
■ YDA


Part No.	Thread	Stroke (mm)	Max energy per cycle (Nm)	Max energy per hour (Nm)	Max effective mass (Kg)	Max impact speed (m/s)	Stop collar
YDA0806	M8 x 1	6	3	7000	6	0,3-2,5	YDG08
YDA1007	M10 x 1	7	6	12400	12	0,3-3,5	YDG10
YDA1210	M12 x 1	10	12	22500	22	0,3-4	YDG12
YDA1412	M14 x 1,5	12	20	33000	40	0,3-5	YDG14
YDA2015	M20 x 1,5	15	59	38000	120	0,3-5	YDG20
YDA2525	M25 x 1,5	25	80	60000	180	0,3-5	YDG25
YDA2725	M27 x 1,5	25	147	72000	270	0,3-5	YDG27

Special strokes upon request

Ambient temperature: -10 ÷ 80 °C

Body: steel

Piston rod: chromium-plated carbon steel

Piston: carbon steel

Adjustable
■ YDR


Part No.	Thread	Stroke (mm)	Max energy per cycle (Nm)	Max energy per hour (Nm)	Max effective mass (Kg)	Max impact speed (m/s)	Stop collars
YDR1415	M14 x 1,5	15	22	26400	80	3	YDG14
YDR2025	M20 x 1,5	25	39	30000	312	3,5	YDG20
YDR2525	M25 x 1,5	25	85	54000	400	3,5	YDG25
YDR2540	M25 x 1,5	40	40	80000	700	3,5	YDG25L
YDR3625	M36 x 1,5	25	25	81000	1400	3,5	YDG36
YDR3650	M36 x 1,5	50	50	100000	1400	3,5	YDG36

Special strokes upon request

Ambient temperature: -10 ÷ 80 °C

Body: steel

Piston rod: chromium-plated carbon steel

Piston: carbon steel

ISO 6432

■ **M**
 Ø 8 ÷ 25 mm Microcylinders



ISO 15552

■ **KL**
 Ø 32 ÷ 125 mm Pneumatic Cylinders



■ **K/KE/KD**
 Ø 32 ÷ 125 mm Pneumatic Cylinders



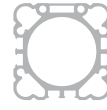
■ **K Ø 160-200**
 Ø 160 - 200 mm Pneumatic Cylinders



ISO 21287

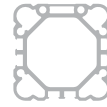
■ RP-RM

Ø 16 ÷ 100 mm Compact Cylinders



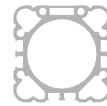
■ RO-RN

Ø 16 ÷ 63 mm Compact Cylinders



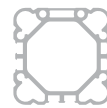
■ RS

Ø 32 ÷ 100 mm STRONG Cylinders



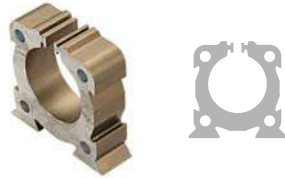
■ RQ

Ø 32 ÷ 63 mm STRONG Cylinders

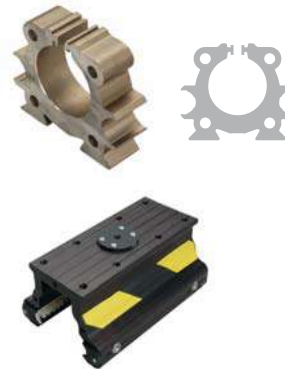


Rodless cylinders

■ **S1**
 Ø 16 ÷ 50 mm Rodless Cylinders
 standard version



■ **S5**
 Ø 25 ÷ 50 mm Rodless Cylinders with integrated guides
 tecnopolymer sliding guide



■ **VL1**
 Ø 25 ÷ 50 mm Rodless Cylinders with integrated guides 90°
 sliding on ball bearings



2

High-Tech



Locking Units

L1-N
L6

3
4



Telescopic Cylinders

RT

6



Pneumatic Actuators

NTZ
NQZ
NFZ

8
8
9



Pneumatic Grippers

YMA
YMP

10/11
10/11

ORIGINAL

Locking system UNIVER Original since 1998

STATIC/DYNAMIC

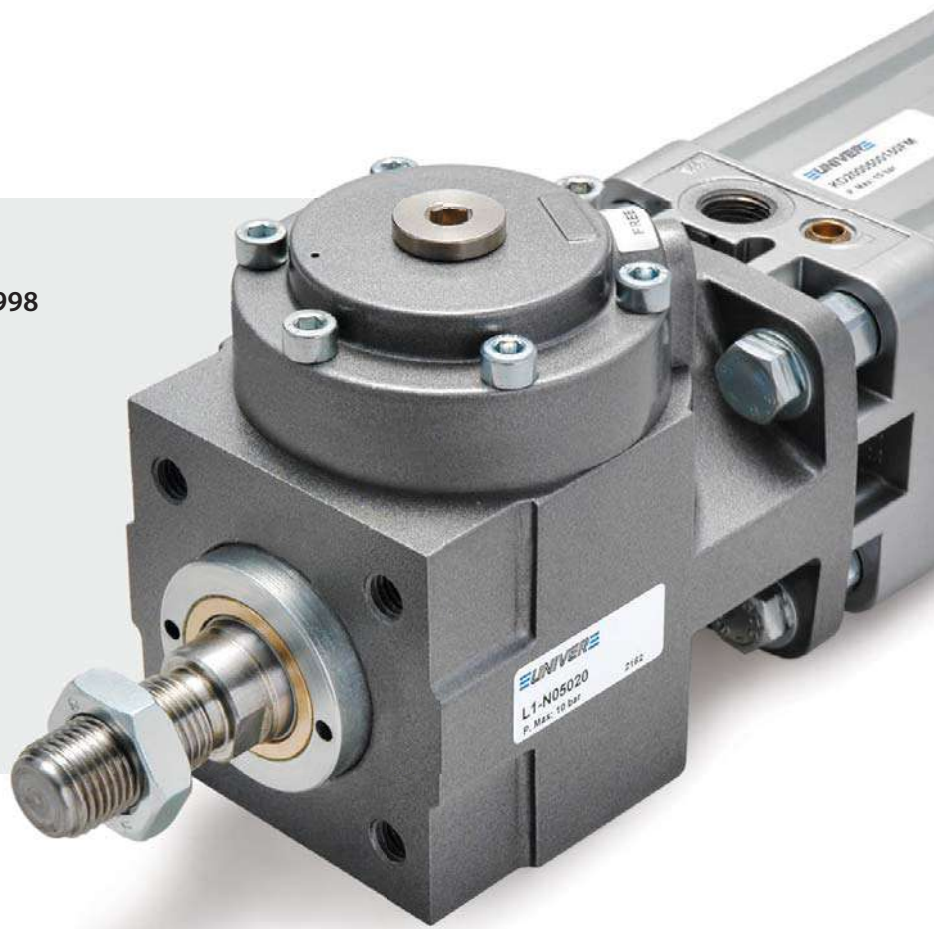
Static locking and dynamic braking in a single device

POWERFUL

The highest locking force among market equivalent devices

SAFE

No rod slipping even if affected by oil and grease



L1-N

For cylinders $\varnothing 16 \div 125$ mm
For piston rods $\varnothing 6 \div 32$ mm

M



KL
KE/K
KD



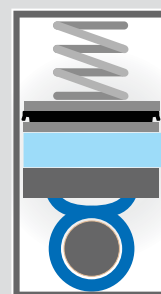
RS



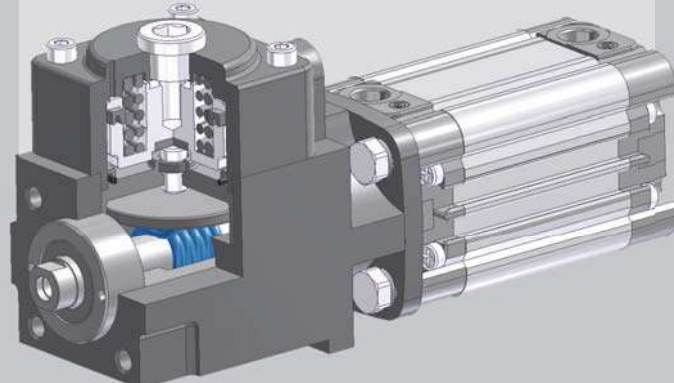
Working principle



Locked piston rod



Free piston rod



CHARACTERISTICS

Ambient temperature	-20 ÷ 30 °C
Fluid	filtered air, with or without lubrication
Working pressure	4 ÷ 10 bar
Body	die-cast aluminium
Cover	die-cast aluminium
Piston	aluminium
Seals	NBR
Springs	special steel

M, KL, KE/K, KD, RS series cylinders


CODIFICATION KEY

L	1	-	N	0	6	3	2	0	
1		2		3		4			

1 Series	2 Cylinder bore (mm)	3 Piston rod bore (mm)	4 Option
L1-N = Locking unit for cylinders and piston rods	016 = Ø16 050 = Ø50 020 = Ø20 063 = Ø63 025 = Ø25 080 = Ø80 032 = Ø32 100 = Ø100 040 = Ø40 125 = Ø125	06 = Ø6 16 = Ø16 08 = Ø8 20 = Ø20 10 = Ø10 25 = Ø25 12 = Ø12 32 = Ø32	K = Metallic piston rod scraper upon request

Core features and performance

Ø	Ø rod (mm)	Static locking force	Pressure on the equivalent cylinder	Dynamic braking force	Response time at 6 bar	Stopping point repeatability	Vibration resistance	Shock resistance	Minimum release pressure
		N	bar	at 1m/s	ms	J		bar	
16	6	200	10	40% of the static locking force	12	< 1 mm at 1 m/s	10 g (10-55 Hz) for 30 minutes on each axis	2	4
20	8	314			12			3	
25	10	490			15			4	
32	12	800			20			5	
40	16	1260			20			8	
50	20	2000			25			11	
63	20	3100			25			15	
80	25	5000			30			21	
100	25	7850			30			29	
125	32	12300			40			40	

■ **NFZ 160/200**
ISO 1552 cylinders with integrated locking unit



■ Locking unit with optical positional device



CHARACTERISTICS

Ambient temperature	-20 ÷ +80 °C
Fluid	filtered air, with or without lubrication
Working pressure	4,5÷10 bar
Body	die-cast aluminium
Seals	NBR
Internal parts	brass/aluminium

UNIVER Locking Units for rodless cylinders perform the function of keeping the carriage in any intended point of its stroke and allow high locking accuracy. They can be mounted on both sides of the carriage and the mechanical braking force can be further increased by means of an additional pneumatic override.


CODIFICATION KEY

L	6	-	S	5	0	3	2
1				2			

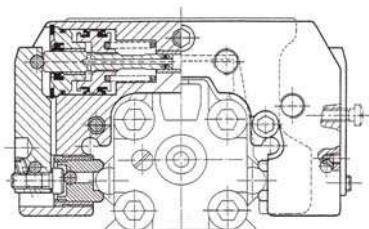
1 Series

L6-S5 = Locking Units for S5 series rodless cylinder
L6-V1 = Locking Units for VL1 series rodless cylinder

2 Cylinder bore (mm)

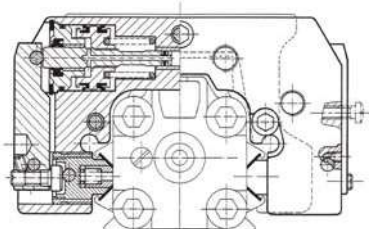
025 = Ø25
032 = Ø32
040 = Ø40
050 = Ø50

■ S5 series with locking unit



- Min. release pressure: 4,5 bar
- Able to keep the carriage in position in both directions
- Easy to be mounted on both sides of the carriage

■ VL1 series with locking unit



- Permanent manual release by means of 2 screws M5
- Locking performed by mechanical springs in absence of air
- Preset for additional pneumatic override to increase locking force

RT | Telescopic Cylinders

ORIGINAL

UNIVER Original design and technology

INDUSTRIALIZED

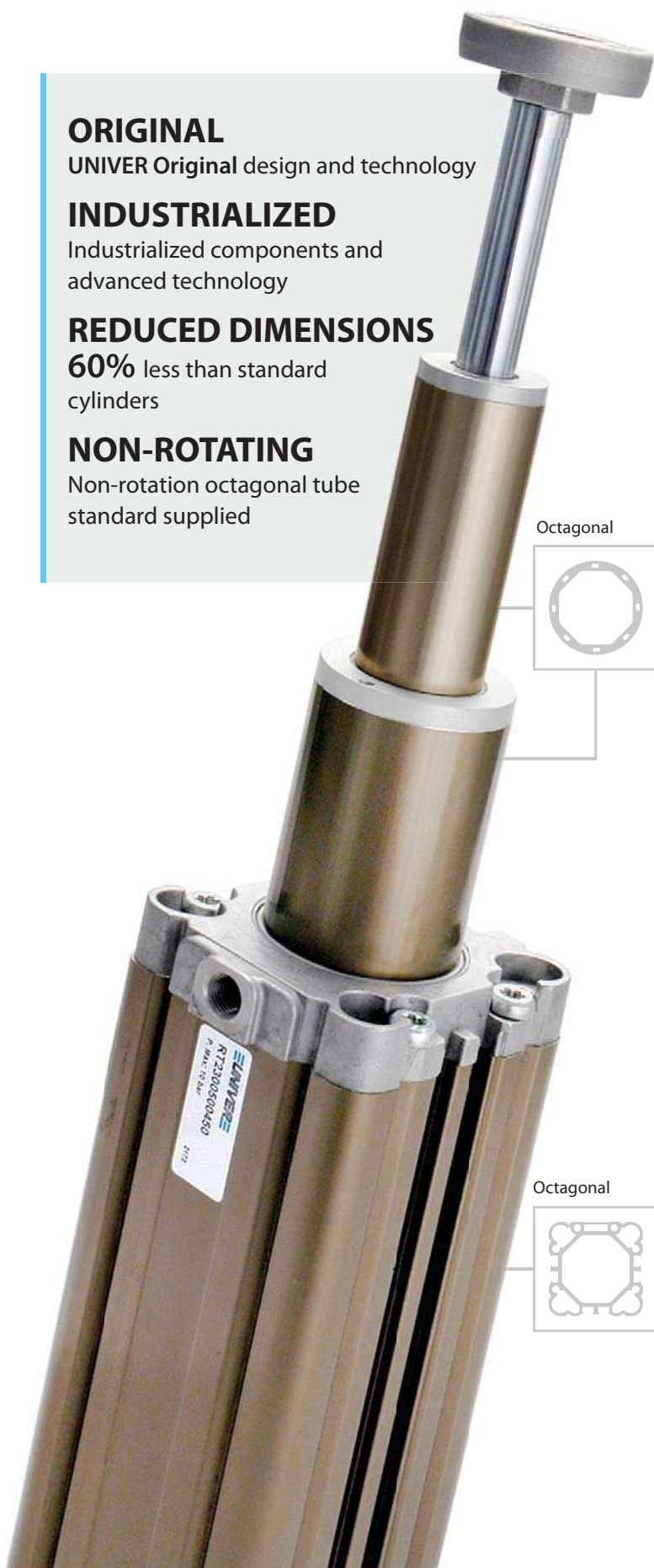
Industrialized components and advanced technology

REDUCED DIMENSIONS

60% less than standard cylinders

NON-ROTATING

Non-rotation octagonal tube standard supplied



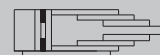
RT2

2 stages $\varnothing 25 \div 63$ mm

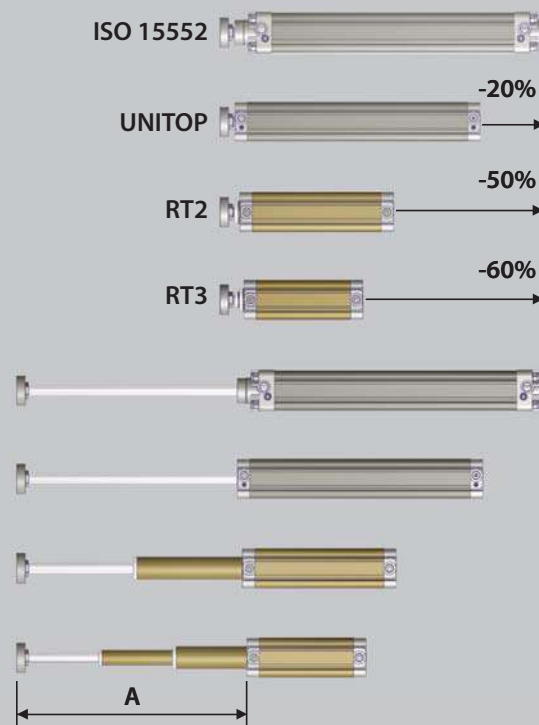


RT3

3 stages $\varnothing 40 \div 63$ mm



Comparison of overall dimensions stroke 300 mm (A)



CHARACTERISTICS

Ambient temperature	-20 ÷ +80 °C
Fluid	filtered air, with or without lubrication
Working pressure	1,5 ÷ 10 bar
End-caps	die-cast aluminium
Barrel	internally/externally anodized aluminium
Piston	aluminium
Guide slide	acetalic resin
Piston rod	non-rotating, chromium-plated steel, with flange (female piston rod) stainless steel upon request
Piston seals	NBR
Guide bush for piston rod	acetalic resin
Shock absorber seals	NBR
Magnet	standard supplied (stage 1)



Telescopic cylinders work under optimal conditions when the load is in axial position, i.e. when the cylinder is placed vertically, working either upward or downward. They can obviously work also horizontally and cantilevered, but in this case it is needed to:

- Reduce the maximum stroke by 50% compared to nominal maximum strokes
- Request cylinders with slide units
- Support the radial load by means of other devices such as carriages, slides or sliding guides

CODIFICATION KEY

R	T	2	2	0	0	3	2	0	6	0	0
---	---	---	---	---	---	---	---	---	---	---	---

1	2	3	4	5	6	7
---	---	---	---	---	---	---

1 Series	2 Rod	3 Stages	4 Type
RT = Ø 25÷63 mm - 2/3 Stage Telescopic Pneumatic Cylinders (with non-rotating piston rod and elastic shock absorber seals)	1 = Stainless steel piston rod 2 = Chromium-plated steel piston rod	2 = 2 stages 3 = 3 stages	0 = D.A. Female piston rod 3 = D.A. Male piston rod D.A. = Double acting

5 Bore (mm)	6 Stroke (mm)	7 Option
2 stages 025 = Ø25 040 = Ø40 032 = Ø32 050 = Ø50 040 = Ø40 063 = Ø63 050 = Ø50 063 = Ø63	2 stages 0100 - 0120 - 0160 - 0180 - 0200 - 0300 - 0400 0500 - 0600 - 0700 - 0800 - 0900 - 1000 - 1100 - 1200 Max stroke: 0300 (Ø25) 0900 (Ø50) 0400 (Ø32) 1200 (Ø63) 0600 (Ø40)	I = Without flange (only for female piston rod) L = Freely rotating piston rod (without flange) M = With telescopic magnetic shaft (stage 2-3) except for Ø 25, only for female piston rod
	3 stages 0150 - 0180 - 0210 - 0240 - 0270 - 0300 - 0360 - 0450 0600 - 0750 - 0900 - 999 - 1101 - 1200 Max stroke: 1200 (Ø40) 1500 (Ø50) 1800 (Ø63)	

Nominal tolerance on stroke (mm) and maximum applicable torque (Nm) for non-rotating piston rod

Ø	Tolerances mm		Applicable torque Nm	
	2 stages	3 stages	2 stages	3 stages
25	+2/0	+4/0	0,5	-
32	+3,2/0	+4/0	0,8	-
40	+3,2/0	+4/0	1	0,5
50	+3,2/0	+4/0	2	0,8
63	+3,2/0	+4/0	3	1

Theoretical forces at 6 bar (N) (2 stages)

Ø	Available surface mm ²		Working pressure bar	
	thrust	traction	thrust	traction
25	201	111	123	65
32	314	201	192	123
40	490	377	300	231
50	804	603	492	369
63	1256	1055	769	649

Theoretical forces at 6 bar (N) (3 stages)

Ø	Available surface mm ²		Working pressure bar	
	thrust	traction	thrust	traction
40	201	111	123	65
50	314	201	192	123
63	490	377	300	231

FIXING ELEMENTS AND ACCESSORIES

Ø	Female hinge with pin	Counter hinge 90° (CETOP)	Male articulated hinge	Rear male hinge	Front / rear flange	Angle bracket	DF sensor and DHF covering strip	Cable clamping for DF sensor
25								
32	-	-	-	RPF-11025	RTF-12025	RTF-13025	DF DHF-0020100	DF-001
40	KF-10032A	KF-19032	KF-11032S	KF-11032	KF-12032	KF-13032		
50	KF-10040A	KF-19040	KF-11040S	KF-11040	KF-12040	KF-13040		
63	KF-10050A	KF-19050	KF-11050S	KF-11050	RTF-12050	RTF-13050		
63	KF-10063A	KF-19063	KF-11063S	KF-11063	RTF-12063	RTF-13063		

NTZ-NQZ-NFZ

Programmable Pneumatic Actuators



NTZ

Pneumatic actuator with integrated digital measuring detector and safety locking device
Ø 32 ÷ 63 mm



NQZ

Pneumatic actuator with digital measuring system
Ø 32 ÷ 63 mm



NFZ

Pneumatic actuator with integrated safety locking device
Ø 32 ÷ 63 mm



Pneumatic actuator with integrated digital measuring system and safety locking device
2
■ NTZ


The system does not need to be connected to the moving part of the mechanism, as movement is generated by an internal piston with bidirectional pneumatic function. Such piston, operated by a 5-way valve, moves autonomously until it meets the obstacle, thus measuring the stopping position. Position detection is obtained by the transformation of the translation movement of the piston rod into the rotary movement of the screw, by means of screw-female screw coupling. Then the encoder turns the rotation into a sequence of electrical impulses.

The piston and the encoder body need to be fixed, i.e. must not move regardless of screw rotation. This is the reason why the cylinder has been designed with octagonal piston and properly modified non-rotating piston rod.

The speed of the impact against the obstacle is limited by proper calibrated reducers which are embodied in the actuator, while the translation speed can be suitably controlled by means of a standard flow regulator.

For the indicated repeatability of reading to be guaranteed, the translation speed needs to be kept as constant as possible.

Main application fields are: mechanisation, palletization and automation of operating machines.

Max speed: 1 m/s

Repeatability accuracy: ± 0,3 mm

CODIFICATION KEY

N	T	Z	0	3	2	0	3	5	0
1			2			3			

1 Series	2 Bore (mm)	3 Max stroke (mm)
NTZ = Ø 32÷63 mm - Pneumatic actuator with integrated digital measuring system and safety locking device	032 = Ø32 040 = Ø40 050 = Ø50 063 = Ø63	0350 (Ø32) 0450 (Ø40) 0600 (Ø50) 0750 (Ø63)

Pneumatic actuator with digital measuring system
■ NQZ


Pneumatic actuators with digital measuring system are particularly suitable for:

- Detection of stopping position
- Anti-collision control in critical sequencing cycles
- Level control in palletization / de-palletization of piled objects
- Identification, classification and dimensional selection of objects (tolerances and rejects)
- Certification stations of machined pieces or tool breaking on machines for chip removal

The device can be used as both digital measuring detector and pneumatic actuator with digital measuring system

Max speed: 0,2 m/sec (detector) 0,8 m/sec (actuator)

Repeatability accuracy: ± 0,02 mm

CODIFICATION KEY

N	Q	Z	0	3	2	0	3	5	0
1		2			3				

1 Series	2 Bore (mm)	3 Max stroke (mm)
NQZ = Ø 32÷63 mm - Pneumatic actuator with integrated digital measuring system	032 = Ø32 040 = Ø40 050 = Ø50 063 = Ø63	0350 (Ø32) 0450 (Ø40) 0600 (Ø50) 0750 (Ø63)

Pneumatic actuator with integrated safety locking device

■ NFZ



Locking device embodied in the cylinder rear part in axial position.
High repeatability and intervention speed (16 ms).

Recommended application:

Emergency braking intervention at the speed allowed by the cylinder; for repeated functioning, as locking unit or braking intervention ≤ 50 mm/s.

Piston rod holding force (without axial backlash): ≥ 3 times the thrust of a cylinder supplied at 6 bar.

Locking force independent from ambient conditions or piston rod maintenance.

Locking device passive functioning, in absence of signal and/or air supply.

Minimum pressure: ≥ 3 bar

CODIFICATION KEY

N	F	Z	0	3	2	0	3	5	0
1			2			3			

1 Series	2 Bore (mm)	3 Max stroke (mm)
NFZ = $\varnothing 32\text{-}63$ mm - Pneumatic actuator with integrated safety locking device	032 = $\varnothing 32$ 040 = $\varnothing 40$ 050 = $\varnothing 50$ 063 = $\varnothing 63$	0350 ($\varnothing 32$) 0450 ($\varnothing 40$) 0600 ($\varnothing 50$) 0750 ($\varnothing 63$)

Angular Pneumatic Gripper
2
■ YMA10


Part No.	Ø	Gripping force (Nm)*		Max arm length L (mm)	Sensor
		Opening	Closing		
YMA10-12	12	0,25	0,2	30	DF-R 200
YMA10-16	16	0,6	0,45	40	
YMA10-20	20	1,15	0,85	60	
YMA10-25	25	2,25	1,7	70	
YMA10-32	32	4,05	3,05	85	

* = Gripping force at 5 bar
 L = Gripping point 30 mm

Working pressure: 1,5 ÷ 7 bar
 Ambient temperature: -5 ÷ 60 °C
 Max frequency (cycles/min): 180
 Opening angle: +30° -10°

Parallel Pneumatic Gripper
■ YMP10


Part No.	Ø	Gripping force (N)*		Max arm length L (mm)	Stroke open/close (mm)	Sensor
		Opening	Closing			
YMP10-12	12	8	5	30	6	DF-R 200
YMP10-16	16	24	17	40	8	
YMP10-20	20	46	33	60	12	
YMP10-25	25	73	57	70	14	
YMP10-32	32	98	81	85	16	

* = Gripping force at 5 bar
 L = Gripping point 30 mm

Working pressure: 1,5 ÷ 7 bar
 Ambient temperature: -5 ÷ 60 °C
 Max frequency (cycles/min): 180

180° Angular Pneumatic Gripper
■ YMA20


Part No.	Ø	Gripping force (N)*	Max arm length L (mm)	Sensor
YMA20-10	10	6	60	DF-T 200
YMA20-16	16	20	70	
YMA20-20	20	36	80	
YMA20-25	25	78	90	

* = Gripping force at 5 bar
 L = Gripping point 30 mm

Working pressure: 1 ÷ 6 bar
 Ambient temperature: -10 ÷ 60 °C
 Max frequency (cycles/min): 60
 Repeatability: ± 0,2
 Opening angle: +180°~182° / -3°

Parallel Pneumatic Gripper with Linear Guide

■ YMP20



Part No.	Ø	Pressure (bar)	Max frequency (cycles/min)	Repeatability (mm)	Gripping force (N)*		Stroke open/close (mm)	Sensor
					Opening	Closing		
YMP20-10	10	2 ÷ 7	180	0,01	11	16	4	DF-T 200
YMP20-16	16	1 ÷ 7	180	0,01	32	44	6	
YMP20-20	20	1 ÷ 7	180	0,01	42	65	10	
YMP20-25	25	1 ÷ 7	180	0,01	67	110	14	
YMP20-32	32	1 ÷ 7	60	0,02	160	228	22	
YMP20-40	40	1 ÷ 7	60	0,02	260	318	30	

* = Gripping force at 5 bar, gripping point 30 mm

Ambient temperature: -10 ÷ 60 °C

Low Profile Parallel Pneumatic Gripper with Linear Guide

■ YMP30



Part No.	Ø	Max frequency (cycles/min)	Gripping force (N)*		Stroke (mm)	Sensor
			Opening	Closing		
YMP30008	8	180	19	19	8-16-32	DF-T200
YMP30012	12		48	48	12-24-48	
YMP30016	16		91	91	16-32-64	
YMP30020	20		138	138	20-40-80	

* = Gripping force at 5 bar, gripping point 30 mm (for version 15 mm YMP30008)

Working pressure: 1,5 ÷ 7 bar
Ambient temperature: -5 ÷ 60 °C

Wide-type Parallel Pneumatic Gripper

■ YMP40



Part No.	Ø	Max frequency (cycles/min)	Gripping force (N)*		Stroke (mm)	Sensor
			Opening	Closing		
YMP40010	10	40	14	14	20-40-60	DF-...
YMP40016	16	40	44	44	30-60-80	
YMP40020	20	40	77	77	40-80-100	
YMP40025	25	40	128	128	50-100-120	
YMP40032	32	20	227	227	70-120-160	

* = Gripping force at 5 bar, gripping point 30 mm

Working pressure: 1 ÷ 6,1 bar
Ambient temperature: -10 ÷ 60 °C
Repeatability: ±0,1

Self-centering 3 Jaw Pneumatic Gripper

■ YMP50



Part No.	Ø	Pressure (Bar)	Max frequency cycles/min	Gripping force (N)*		Stroke (mm)	Sensor
				Opening	Closing		
YMP50-16	16	2 - 6	120	14	16	4	DF-...
YMP50-25	25	2 - 6	120	41	46	6	
YMP50-32	32	1 - 6	60	73	81	8	
YMP50-40	40	1 - 6	60	117	127	8	
YMP50-50	50	1 - 6	60	180	204	12	
YMP50-63	63	1 - 6	60	332	359	16	
YMP50-80	80	1 - 6	30	495	520	20	
YMP50-100	100	1 - 6	30	745	775	24	
YMP50-125	125	1 - 6	30	1265	1310	32	









* = Gripping force at 5 bar, gripping point 20 mm (Ø16-25) 30 mm (Ø 32÷63) 50 mm (Ø 80 ÷125)

Ambient temperature: -10 ÷ 60 °C
Repeatability: ±0,01

3

Valves



	Electropilots	B11 B10 B12 B A AA AB	3 4 5 7 8 9 10
	Standards-based Valves	BE/BE12 AE BD AC-N	12 15 17 22
	Spool Valves	CL/CM E F G6/GL6 G7 PS	23 30 33 34/37 41 43
	Poppet Valves	AC CH AF/AG AI AI-JET AI-JET2 AM	48 50 52/54 56 57 59 60
	COMPACT Valves	P10 P15 P15E	62 71 80
	Serial Connections	TC	84
	Accessories	COILS OPERATORS	86 88
	Complementary Valves	YR AP/AM HZ9N YF YG-6300	90 92 94 95 96

Standard
Low consumption
High flow rate
Magnetic memory
B11
B10
B12
LATCHING

 1 w
 15 NI/min

 0,3 w
 15 NI/min

 0,6 w
 30 NI/min

 Special version
40 NI/min

 Energizing through short impulse,
 de-energizing through the same
 impulse with inverted polarity.


B11 / B10 / B12

ISO 15218 Nanovalves


NEW

 Sub-base with
 integrated electrical
 connection

 Manual override
 (standard)

 ISO 15218
 interface

 No manual override
 (upon request)


LED

 90°
 connector

 In-line
 connector

 In-line
 PIN

 90°
 cables

 In-line
 cables


CHARACTERISTICS

Ambient temperature	-5 ÷ +50 °C
Fluid	10 µm filtered air, with or without lubrication
Max pressure	9 bar
Operating frequency	5 Hz
Fixing	2 screws M1,6
Connections	ISO 15218 interface
Nominal bore (mm)	0,8 (3/2 NC) 1,3 (3/2 NO)
Nominal flow rate (NI/min)	15
Valve body	self-extinguishing technopolymer
Seals	VITON/NBR
Voltage	24 V DC (12V DC upon request)
Power consumption	1 W
Electrical connection	D-535U40 (IP65), solder pin (IP00), Molex
Led	yellow (standard)
Manual override	monostable button



CODIFICATION KEY

B	1	1	-	4	0	1	L	2	4	D
	1			2	3	4	5		6	

1 Series B11 = ISO 15218 - 10 mm Nanovalves - 1 W standard	2 Model 4 = Monostable	3 Type 0 = 3/2 NC Ø 0,8 mm (1 W) 1 = 3/2 NO Ø 1,3 mm (1 W)
4 Function 1 = Manual override, in-line PIN 2 = No manual override, in-line PIN 3 = Manual override, PIN on interface side 4 = No manual override, PIN on interface side 5 = Manual override, PIN opposed to the interface 6 = No manual override, PIN opposed to the interface	5 Variant L = 90° Connector (protected PIN) M = In-line connector (protected PIN, Molex connection) P = In-line PIN (suitable for mounting on circuit boards)	6 Voltage 24D = 24 V DC 12D = 12 V DC (upon request)

Fixing screws standard supplied. Max tightening torque 0,15 Nm
Other versions upon request: in-line cables and 90° cables

Connector	Pin
<p>■ 90° Connector</p> <p>B11-401L24D B11-411L24D</p>	<p>■ In-line connector NEW</p> <p>B11-405M24D B11-415M24D</p>
	<p>■ In-line PIN</p> <p>B11-403P24D B11-413P24D</p>

D-535U40300/500	D-530-30/50/200
<p>Single connector with wire D-535U40300 = wire length 300 mm D-535U40500 = wire length 500 mm</p>	<p>Miniature connector with loose cables D-530-30 = wire length 300 mm D-530-50 = wire length 500 mm D-530-200 = wire length 2000 mm</p>

CHARACTERISTICS

Ambient temperature	-5 ÷ +50 °C
Fluid	10 µm filtered air, with or without lubrication
Max pressure	7 bar
Operating frequency	5 Hz
Assembly	2 screws M1,6
Connections	ISO 15218 interface
Nominal bore (mm)	0,8
Nominal flow rate (NI/min)	15
Valve body	self-extinguishing technopolymer
Seals	VITON/NBR
Voltage	24 V DC (12V DC upon request)
Power consumption	0,3 W (speed-up 1 W)
Electrical connection	D-535U40 (IP65), solder pin (IP00), Molex
Led	yellow (standard)
Manual override	monostable button


CODIFICATION KEY

B	1	0	-	4	0	1	L	2	4	D
	1			2	3	4	5		6	

1 Series B10 = ISO 15218 - 10 mm Nanovalves - low power consumption	2 Model 4 = Monostable	3 Type 0 = 3/2 NC Ø 0,8 mm (0,3 W)
---	----------------------------------	--

4 Function 1 = Manual override, in-line PIN 2 = No manual override, in-line PIN 3 = Manual override, PIN on interface side 4 = No manual override, PIN on interface side 5 = Manual override, PIN opposed to the interface 6 = No manual override, PIN opposed to the interface	5 Variant L = 90° Connector (protected PIN) M = In-line connector (protected PIN, Molex connection) P = In-line PIN (suitable for mounting on circuit boards)	6 Voltage 24D = 24 V DC 12D = 12 V DC (upon request)
--	---	---

Fixing screws standard supplied. Max tightening torque 0,15 Nm
Other versions upon request: in-line cables and 90° cables, nominal flow rate 40 NI/min

Connector	PIN		
<ul style="list-style-type: none"> 90° Connector <p>B10-401L24D</p>	<ul style="list-style-type: none"> In-line connector NEW <p>B10-405M24D</p>	<ul style="list-style-type: none"> In-line PIN <p>B10-403P24D</p>	<ul style="list-style-type: none"> Latching in-line PIN (with magnetic memory) <p>This version is energized by an electrical impulse and de-energized by a similar impulse with inverted polarity.</p> <p>For further information please contact our Sales Office</p>

D-535U40300/500	D-530-30/50/200
<p>Single connector with wire D-535U40300 = wire length 300 mm D-535U40500 = wire length 500 mm</p>	<p>Miniature connector with loose cables D-530-30 = wire length 300 mm D-530-50 = wire length 500 mm D-530-200 = wire length 2000 mm</p>

CHARACTERISTICS


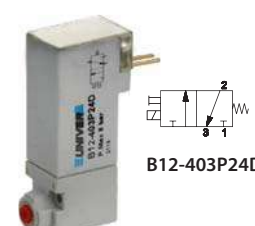
Ambient temperature	-5 ÷ +50 °C
Fluid	10 µm filtered air, with or without lubrication
Max pressure	7 bar
Operating frequency	5 Hz
Fixing	2 screws M1,6
Connections	ISO 15218 interface
Nominal bore (mm)	1,3
Nominal flow rate (NI/min)	30
Valve body	self-extinguishing technopolymer
Seals	VITON/NBR
Voltage	24 V DC (12 V DC upon request)
Power consumption	0,6 W (speed-up 1 W)
Electrical connection	D-535U40 (IP65), solder pin (IP00), Molex
Led	yellow (standard)
Manual override	monostable button

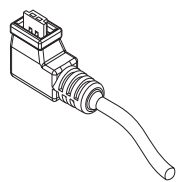
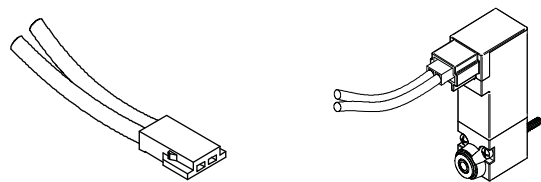

CODIFICATION KEY

B	1	2	-	4	0	1	L	2	4	D
	1			2	3	4	5		6	

1 Series B12 = ISO 15218 - 10 mm Nanovalves - high flow rate	2 Model 4 = Monostable	3 Type 0 = 3/2 NC Ø 1,3 mm (0,6 W)
4 Function 1 = Manual override, in-line PIN 2 = No manual override, in-line PIN 3 = Manual override, PIN on interface side 4 = No manual override, PIN on interface side 5 = Manual override, PIN opposed to the interface 6 = No manual override, PIN opposed to the interface	5 Variant L = 90° connector (protected PIN) M = In-line connector (protected PIN, Molex connection) P = In-line PIN (suitable for mouting on circuit boards)	6 Voltage 24D = 24 V DC 12D = 12 V DC (upon request)

Fixing screws standard supplied. Max tightening torque 0,15 Nm
 Other versions (upon request): In-line cables and 90° cables, nominal flow rate 40 NI/min

Connector	PIN	
■ 90° Connector  B12-401L24D	■ In-line connector NEW  B12-405M24D	■ In-line PIN  B12-403P24D

D-535U40300/500	D-530-30/50/200
 <p>Single connector with wire D-535U40300 = wire length 300 mm D-535U40500 = wire length 500 mm</p>	 <p>Miniature connector with loose cables D-530-30 = wire length 300 mm D-530-50 = wire length 500 mm D-530-200 = wire length 2000 mm</p>

B 10 mm

1,2 w
12 NI/min

NEW
0,5 w



A 15 mm

2 w
38 NI/min



DETENT SYSTEM UNIVER Original since 1988

B 10 mm

3/2 NC - NO



Revolving coil
180° x 180°



Manual
override



Atmosphere
exhaust



Conveyed
exhaust

A 15 mm

2/2 NC - NO, 3/2 NC - NO



Revolving coil
90° x 90°



Manual
override



ISO 15218
interface



90° connector

In-line connector

Loose cables



Faston

90° connector

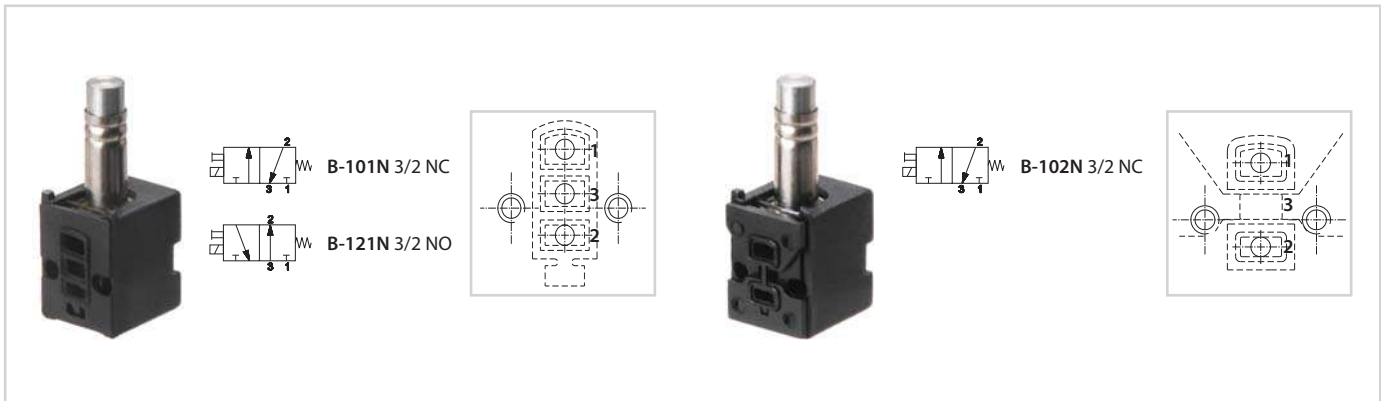
In-line connector

Loose cables

CHARACTERISTICS		
Ambient temperature	-5 ÷ +50 °C	
Fluid	10 µm filtered air, with or without lubrication	
Commutation system	poppet	
Max pressure	8 bar	
Fixing	2 screws M1,6	
Connections	on sub-base	
Nominal bore (mm)	0,5	0,6
Nominal flow rate (NI/min)	9	12
Max frequency	2300 ÷ 3000 cycles/min	
Valve body	technopolymer (aluminium external cover)	
Seals	NBR	
Power consumption	1,2 W (1,35 W with LED) - 0,5 W (speed-up 1,2 W)	
Electrical connection	Molex bipolar connector or loose cables	
Voltage	12 V DC - 24 V DC	
Manual override	recessed button - 1 position	



Valves with conveyed exhaust Valves with atmosphere exhaust



Revolving coil 180°x180°

Coils

DE-352 24 V DC 1,2 W DE-452 24 V DC 1,35 W DE-355 24 V DC 0,5 W NEW	DE-552 24 V DC 1,2 W DE-652 24 V DC 1,35 W DE-555 24 V DC 0,5 W NEW	DE-052L030 24 V DC 1,2 W	DE-642I 12 V DC 1,35 W DE-652I 24 V DC 1,35 W DE-655I 24 V DC 0,5 W NEW
--	--	--------------------------	--

Coil with 90° upward connector 12 V DC upon request	Coil with integrated in-line connector 12 V DC upon request	Coil with loose cables 12 V DC upon request	Coil with in-line connector with protection for a complete tightness
--	--	--	---

D-500	D-530-30/50/200	D-535-30/50/200	NEW 0,5 W Low power consumption
Miniature connector without wires	Miniature connector with loose cables D-530-30 = wire length 300 mm D-530-50 = wire length 500 mm D-530-200 = wire length 2000 mm	Miniature connector with cables D-535-30 = wire length 300 mm D-535-50 = wire length 500 mm D-535-200 = wire length 2000 mm	

Solenoid valves are supplied without coil and connector

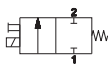
CHARACTERISTICS

Ambient temperature	-5 ÷ +50 °C	
Fluid	10 µm filtered air, with or without lubrication	
Commutation system	poppet	
Max pressure	9 bar	
Fixing	nr. 2 screws M3	
Connections	ISO 15218 interface	
Nominal bore (mm)	1,2	1,5
Nominal flow rate (NI/min)	26	38
Max frequency	2700 cycles/min	
Valve body	technopolymer (aluminium external cover)	
Seals	NBR	
Power consumption	2 W DC / 2,3 VA AC (Ø 1,2) - 2,5 W DC / 3,5 VA AC (Ø 1,5)	
Electrical connection	15 mm connector - Molex bipolar connector or loose cables	
Voltage	24 V DC - 12 V DC - 24 V AC - 110 V AC - 230 V AC	
Manual override	recessed button - 1 position (other manual overrides upon request)	
Protection degree with connector	IP65	



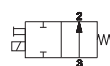
15 mm Microvalves

■ NC



	Ø	Voltage
A-141N	1,2	2 W DC
A-142N	1,5	2,5 W DC
A-151N	1,2	V DC/AC 2W/2 VA
A-101N	1,2	2 W DC
A-102N	1,5	2,5 W DC
A-111N	1,2	V DC/AC 2W/2 VA
A-112N	1,5	V DC/AC 2,5W/3,5 VA

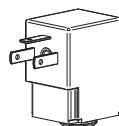
■ NO



	Ø	Voltage
A-161N	1,2	2 W DC
A-162N	1,5	2,5 W DC
A-171N	1,2	V DC/AC 2W/2 VA
A-121N	1,2	2 W DC
A-122N	1,5	2,5 W DC
A-131N	1,2	V DC/AC 2W/2 VA

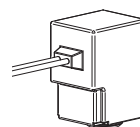
Revolving coil 90°x90°

Coils



DD-011	24 V AC - 50/60 Hz - 3,5 VA
DD-013	230 V AC - 50/60 Hz - 3,5 VA
DD-040	24 V AC - 50/60 Hz - 2,3 VA
DD-041	12 V DC - 2 W
DD-042	12 V DC 2,5 W

DD-050	48 V AC - 50/60 Hz - 2,3 VA
DD-051	24 V DC - 2 W
DD-052	24 V DC - 2,5 W
DD-060	110 V AC - 50/60 Hz - 2,3 VA
DD-070	230 V AC - 50/60 Hz - 2,3 VA



DD-051L030	24 V DC - 2 W
DD-052L030	24 V DC - 2,5 W

24 V DC Faston connector
12 V DC upon request

24 V DC Coil with loose cables
12 V DC upon request

Sub-base for external electrical connection



A-326A	- __ G1/8 (standard)
A-326B	- __ M5 (upon request)
A-326D	- __ tube 4 (upon request)

__ = Number of positions

Sub-base for integrated electrical connection



For further information please contact our Sales Office

A-299-11

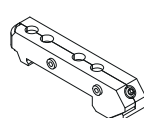
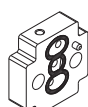
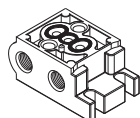
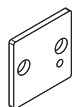
A-301

A-305

A-350

A-345

Manual override



Sealing plate

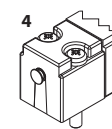
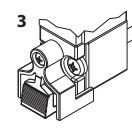
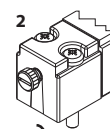
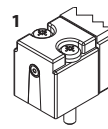
Blank end-plate

Single base

Inverter plate

46277/3
(EN50022) DIN
rail adaptor

- 1 = Recessed button - 1 position (standard supplied) →
- 2 = Impulse screw - 1-2 positions (upon request) ⊖
- 3 = Front button - 1 position (upon request) →
- 4 = Key button - 1 position (upon request) →



Solenoid valves are supplied without coil and connector

CHARACTERISTICS

Ambient temperature	-10 ÷ +50 °C			
Fluid	50 µm filtered air, with or without lubrication; neutral gases (versions for different fluids available upon request)			
Commutation system	direct intervention poppet with cushioned seals			
Pressure	0 ÷ 10 bar (2/2, 3/2 NC), 3 ÷ 10 bar (3/2 NO)			
Connections	on sub-base / threaded on the body			
	sub-base	G 1/8	M5	CNOMO
Nominal bore (mm)	1,2 ÷ 1,5	1 ÷ 1,5	1 ÷ 1,5	1,2 ÷ 1,5
Nominal flow rate (NI/min)	30 ÷ 60	28 ÷ 60	30 ÷ 60	33 ÷ 45
Power consumption	3,5 W (DC) - 5 VA (AC)		2,5 W (DC) - 3,3 VA (AC)	
Connector	AM-5110		AM-5111	
Sleeve	U1			
Coil	DA - DC			
Voltage	12 V DC - 24 V DC - 24 V AC - 110 V AC - 230 V AC			
Protection degree	IP65			

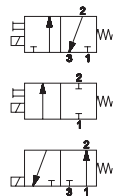

U1 Sleeves - with moving core
Coil-sleeve locking nuts

 AA-0150 3/2 NO
 AA-0157 3/2 NC
 AA-0170 2/2 NC

 AM-5213A 3/2 NO
 AM-5211A 3/2 NC
 AM-5211B 2/2 NC

2/2 - 3/2 U1 Electropilot
2/2 - 3/2 U1 Electropilot G1/8

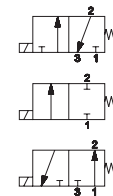
■ For mounting on U1 G1/8 sub-base



AA-0184

AA-0186

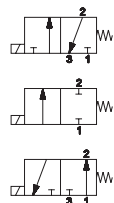
AA-0188



AA-0211

AA-0219

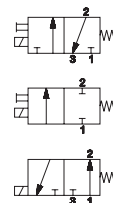
AA-0213

2/2 - 3/2 U1 Electropilot M5
2/2 - 3/2 U1 CNOMO Electropilot


AA-0231

AA-0239

AA-0233


 AA-0400
 AA-0400U

AA-0402

AA-0404

SPEED Series modular sub-base

■ U1 sub-base G1/8

■ CNOMO sub-base G1/8



AA-0450


 2/2 - 3/2
 U1 Electropilot


AB-0900


 2/2 - 3/2
 U1 CNOMO Electropilot

Manual override:

Impulse screw – 2 positions (standard supplied). Recessed button - 1 position, Impulse screw - 1-2 positions, Locking nut with button – 1 position (upon request)

Solenoid valves are supplied without coil and connector

CHARACTERISTICS

Ambient temperature	-10 ÷ +50 °C			
Fluid	10 µm filtered air, with or without lubrication; neutral gases (versions for different fluids available upon request)			
Commutation system	direct intervention poppet with cushioned seals			
Pressure	0 ÷ 10 bar (2/2, 3/2 NC), 3 ÷ 10 bar (3/2 NO)			
Connections	on sub-base / threaded on the body			
	sub-base	G 1/8	G1/4	CNOMO
Nominal bore (mm)	2,1 ÷ 2,4	2,1 ÷ 2,4	1,6 ÷ 6	2,1 ÷ 2,4
Nominal flow rate (NI/min)	92 ÷ 150	100 ÷ 155	95 ÷ 650	92 ÷ 110
Power consumption	11W (DC) - 10 VA (AC)			
Connector	AM-5111			
Sleeve	U2			
Coil	DB			
Voltage	12 V DC - 24 V DC - 24 V AC - 110 V AC - 230 V AC			
Protection degree	IP65			


U2 Sleeves - with moving core
Coil-sleeve locking nuts


AB-0600 3/2 NO
 AB-0613 3/2 NC
 AB-0640 2/2 NC^(a)
 AB-0643 2/2 NC

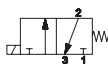


AM-5214A 3/2 NO
 AM-5212A 3/2 NC
 AM-5212B 2/2 NC

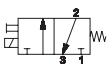
(a) = Suitable for bases with diameter 3 ÷ 6 mm

2/2 - 3/2 U2 Electropilot
2/2 - 3/2 U2 Electropilot G1/8

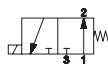
■ For mounting on U2 sub-base G1/8



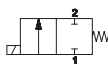
AB-0681



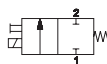
AB-0687



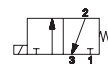
AB-0685



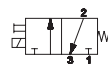
AB-0722



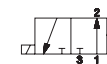
AB-0728



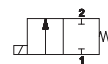
AB-0751



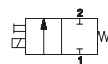
AB-0757



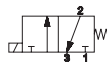
AB-0755



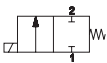
AB-0765



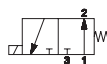
AB-0771

2/2 - 3/2 U2 Electropilot G1/4
2/2 - 3/2 U2 CNOMO Electropilot


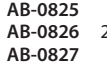
AB-0822



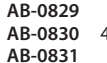
AB-0824



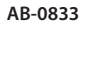
AB-0819



AB-0825



AB-0826



AB-0827



AB-0828



AB-0829



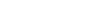
AB-0830



AB-0831



AB-0832



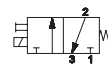
AB-0833

Ø Max Pressure (bar)

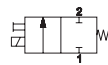
AB-0824	1,6	30
AB-0825	2	20
AB-0826	2,4	15
AB-0827	3	10
AB-0828	3,5	9
AB-0829	4	8
AB-0830	4,5	7
AB-0831	5	6,5
AB-0832	5,5	6
AB-0833	6	5

■ U2 - 17 VA Coil for version 2/2
 DB-0607 24V AC - 50/60 Hz
 DB-0608 110V AC - 50/60 Hz
 DB-0610 220V AC - 50/60 Hz

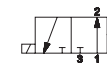
■ For mounting on U2 G1/8 SPEED sub-base



AB-0885



AB-0886



AB-0888

The bore (mm) indicated on 3/2 valves refers to the exhaust

SPEED Series modular sub-base

■ U2 G1/8 sub-base



AB-0900



2/2 - 3/2
U2 Electropilot



2/2 - 3/2
U2 CNOMO Electropilot

Manual override:

Impulse screw – 2 positions (standard supplied). Recessed button - 1 position, Impulse screw - 1-2 positions, Locking nut with button – 1 position (upon request)

Solenoid valves are supplied without coil and connector

ORIGINAL

Valves and sub-bases UNIVER Original since 1980

MIXED and SPOOL SYSTEM

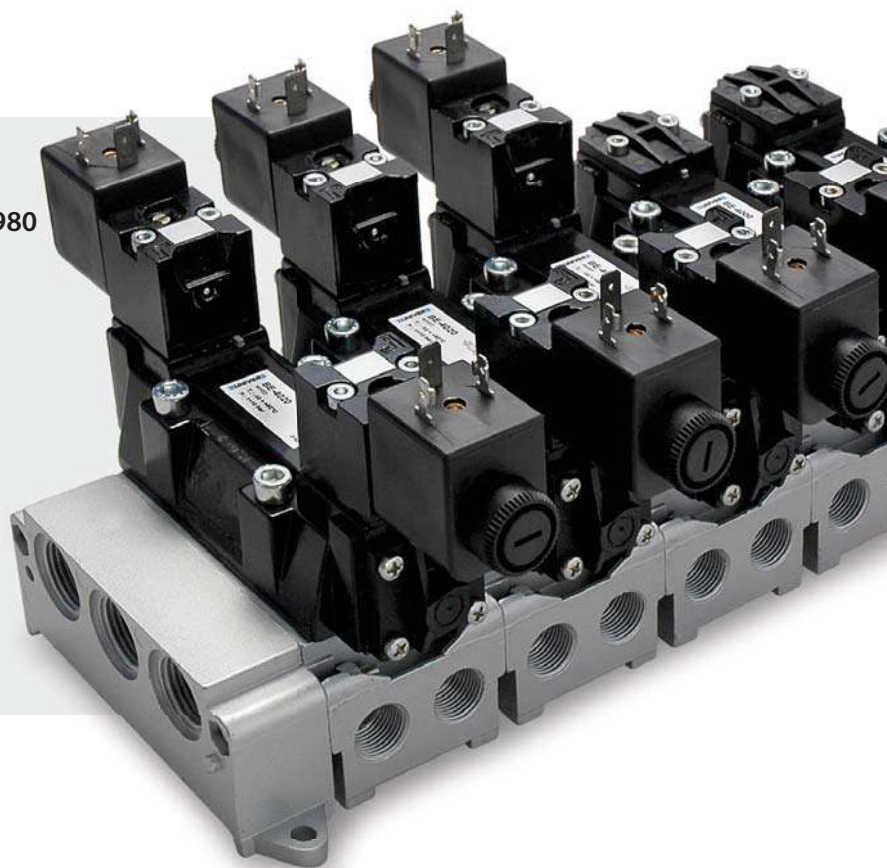
Versions with either mixed or spool system available for all series



MIXED
for heavy applications



SPOOL
for all applications



BE 3

ISO 1



M12

1480
NI/min

BE 4

ISO 2



M12

2300
NI/min

BE 5

ISO 3



M12

4200
NI/min

BE 6

ISO 4



6600
NI/min

CHARACTERISTICS

Ambient temperature	-10 ÷ +50 °C			
Fluid	50 µm filtered air (mixed system)			
	50 µm filtered air, with or without lubrication (spool system)			
Commutation system	mixed and spool			
Max pressure	10 bar			
Connection	ISO 5599/1 interface			
	size 1	size 2	size 3	size 4
Nominal bore (mm)	8	10	15	19
Nominal flow rate (NI/min)	1480	2300	4200	6600
Valve body	acetalic resin with zamak cover			
Seals	NBR and polyurethane (mixed system), NBR (spool system)			
Electropilot/Coil	AA series/U3			
Power consumption	2,5 W (DC) - 5 VA (AC)			
Voltage	12 V DC - 24 V DC - 24 V AC - 110 V AC - 230 V AC			
Manual override	impulse screw - 2 positions (BE), recessed button - 1 position (BE12)			



BE Single/double pneumatic impulse

	■ MIXED SYSTEM		size		size		size
		BE-3100 1 BE-4100 2 BE-5100 3 BE-6100 4		BE-3150 1 BE-4150 2 BE-5150 3 BE-6150 4		BE-3170 1 BE-4170 2 BE-5170 3 BE-6170 4	
	■ SPOOL SYSTEM		size		size		size
		BE-3800 1 BE-4800 2 BE-5800 3 BE-6800 4		BE-3850 1 BE-4850 2 BE-5850 3 BE-6850 4		BE-3870 1 BE-4870 2 BE-5870 3 BE-6870 4	

BE Single electrical impulse

	■ MIXED SYSTEM		size		size
		BE-3000 1 BE-4000 2 BE-5000 3 BE-6000 4		BE-3060 1 BE-4060 2 BE-5060 3 BE-6060 4	
	■ SPOOL SYSTEM		size		size
		BE-3700 1 BE-4700 2 BE-5700 3 BE-6700 4		BE-3760 1 BE-4760 2 BE-5760 3 BE-6760 4	

BE Double electrical impulse

	■ MIXED SYSTEM		size		size
		BE-3020 1 BE-4020 2 BE-5020 3 BE-6020 4		BE-3030 1 BE-4030 2 BE-5030 3 BE-6030 4	
		BE-3200* 1 BE-4200* 2 BE-5200* 3 BE-6200* 4		BE-3205 1 BE-4205 2 BE-5205 3 BE-6205 4	
	■ SPOOL SYSTEM		size		size
	BE-3720 1 BE-4720 2 BE-5720 3 BE-6720 4		BE-3730 1 BE-4730 2 BE-5730 3 BE-6730 4		
	BE-3900 1 BE-4900 2 BE-5900 3 BE-6900 4		BE-3940 1 BE-4940 2 BE-5940 3 BE-6940 4		

* = For version with manual override contact our Sales Department

For versions with recessed button 1 position, add suffix U to part number
Solenoid valves are supplied without coil and connector

BE12 Single electrical impulse

	■ MIXED SYSTEM		■ SPOOL SYSTEM	
		size		size
		BE12-3000 1	BE12-3700 1	
		BE12-4000 2	BE12-4700 2	
		BE12-5000 3	BE12-5700 3	

BE12 Double electrical impulse

	■ MIXED SYSTEM		■ SPOOL SYSTEM	
		size		size
		BE12-3020 1	BE12-3720 1	BE12-3940 1
		BE12-4020 2	BE12-4720 2	BE12-4940 2
		BE12-5020 3	BE12-5720 3	BE12-5940 3
		BE12-3205 1	BE12-3900 1	
		BE12-4205 2	BE12-4900 2	
		BE12-5205 3	BE12-5900 3	

Single sub-base, side connections

■ ISO 1	■ ISO 2	■ ISO 3	■ ISO 4
BF-1060 G1/8	BF-1150 G1/4	BF-3060 G1/2	BF-4060 G3/4
BF-1061 G1/4	BF-1151 G3/8	BF-3061 G3/4	BF-4061 G1

Single sub-base, bottom connections

■ ISO 1	■ ISO 2
BF-1062 G1/8	BF-1152 G1/4
BF-1063 G1/4	BF-1153 G3/8
Single or Manifold with separate exhausts	
■ ISO 3	■ ISO 4
BF-3063 G3/4	BF-4062 G3/4
	BF-4063 G1

Manifold universal system sub-base, bottom and side connections, conveyed exhaust

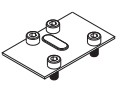
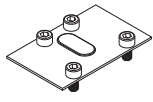
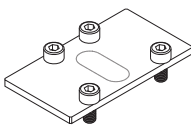

■ ISO 1	■ ISO 2	■ ISO 3
BF-1071 G1/8	BF-1160 G1/4	BF-3071 G1/2
BF-1072 G1/4	BF-1161 G3/8	BF-3072 G3/4
BF-1071S G1/8		
BF-1072S G1/4		

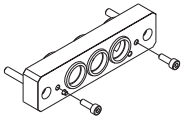
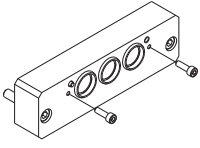
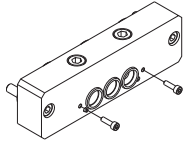
Manifold universal system inlet plate

<p>■ ISO 1</p>  <p>BF-1065 G3/8</p>  <p>BF-1066 G3/8</p>  <p>BF-1068 G3/8</p>	<p>■ ISO 2</p>  <p>BF-1154 G1/2</p>  <p>BF-1155 G1/2</p>	<p>■ ISO 3</p>  <p>BF-3064 G1</p>
--	--	--

Manifold universal system diaphragm

<p>■ ISO 1</p>  <p>BF-1070</p>	<p>■ ISO 2</p>  <p>BF-1162</p>
---	---

BF-1085	BF-1175	BF-3175	BF-3082
			
closing plate for ISO 1 sub-base	closing plate for ISO 2 sub-base 2	closing plate for ISO 3 sub-base 3	universal system plug for ISO 3 sub-base

BF-1190	BF-3190	BF-3191
		
connecting interface for universal sub-bases size 1 - 2	connecting interface for universal sub-bases size 2 - 3	connecting interface for universal sub-bases size 1 - 3

CHARACTERISTICS

Ambient temperature	-10 ÷ +50 °C	
Fluid	50 µm filtered air, with or without lubrication	
Commutation system	mixed	
Max pressure	10 bar	
Connections	ISO 5599/1 interface (BF series sub-bases)	
Nominal bore (mm)	size 1	size 2
Nominal flow rate (NI/min)	8	10
Valve body	acetalic resin	
Seals	NBR, polyurethane	
Electropilot/Coil	AA series/U1	
Power consumption	3,5 W (DC) - 5 VA (AC)	
Voltage	12 V DC - 24 V DC - 24 V AC - 110 V AC - 230 V AC	
Connector	AM-5110	
Manual override	impulse screw - 2 positions	



Single/double pneumatic impulse

	size	AE-1009	1	AE-1120	2
--	------	---------	---	---------	---

	size	AE-1010	1	AE-1121	2
--	------	---------	---	---------	---

Single electrical impulse

Double electrical impulse

	size	AE-1000	1	AE-1100	2
--	------	---------	---	---------	---

	size	AE-1003	1	AE-1103	2
--	------	---------	---	---------	---

ISO 1 Sub-base and plate

BF-1060	BF-1061	BF-1062	BF-1063	BF-1071	BF-1071S	BF-1072	BF-1072S	BF-1065	BF-1066	BF-1068	BF-1070
G1/8	G1/4	G1/8	G1/4	G1/8	G1/8	G1/4	G1/4	On top	Rear	In line	

ISO 2 Sub-base and plate

BF-1150	BF-1151	BF-1152	BF-1153	BF-1160	BF-1161	BF-1154	BF-1155	BF-1162
G1/4	G3/8	G1/4	G3/8	G1/4	G3/8	In line	Rear	

Solenoid valves are supplied without coil and connector


BDE

Integrated electrical connection (ISO 15407/2)


BDB

M12 connector (Automotive)


BDA

Single electrical connection (ISO 15407/1)


BDA

Pneumatic connection (ISO 15407/1)



ISO 02

18 mm



■ ISO Interface



■ OVERSIZED interface (UNIVER original)


620
NI/min

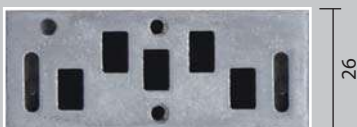
800
NI/min

ISO 01

26 mm



■ ISO Interface



■ OVERSIZED interface (UNIVER original)


1250
NI/min

1700
NI/min

CHARACTERISTICS

Ambient temperature	-20 ÷ +50 °C
Fluid	50 µm filtered air, with or without lubrication
Commutation system	spool
Max pressure	9 bar (electrical) 10 bar (pneumatic)
Connections	ISO 15407-1/2 interface
Nominal bore (mm)	6 (18 mm) 8 (26 mm)
Nominal flow rate (NI/min)	see table below
Valve body	acetalic resin with aluminium cover
Seals	nitrile rubber
Spool	aluminium
Electropilot/Coil	A series/U05
Voltage	12 V DC - 24 V AC/DC - 48 V AC - 110 V AC - 230 V AC
Power consumption	2 W
Manual override	recessed button - 1 position
Protection degree	IP65


CODIFICATION KEY

B	D	E	-	3	3	4	4	2	4	
1				2	3	4	5	6	7	

1 Series	2 Size	3 Type
BDE = Solenoid valves with integrated electrical connection 24 V DC	BDB = Solenoid valves with electrical connection 24 V DC, with connector M12	2 = 5/2 6 = 3/2+3/2 NC-NC 3 = 5/3 c.c. 7 = 3/2+3/2 NC-NO 4 = 5/3 o.c. 8 = 3/2+3/2 NO-NO 5 = 5/3 p.c.

Coils and connectors included

4 Control 14	5 Return 12	6 Coil voltage	7 Options
4 = Electrical amplified	0 = Pneumomechanical spring 1 = Mechanical spring 4 = Electrical amplified 7 = Electrical not amplified	24 = 24 V DC (standard) 12 = 12 V DC (upon request)	D = External pilot supply

B	D	A	-	3	3	4	4	
1				2	3	4	5	6

1 Series	2 Size	3 Type
BDA = Valves and solenoid valves	3 = 18 mm 4 = 26 mm	2 = 5/2 6 = 3/2+3/2 NC-NC 3 = 5/3 c.c. 7 = 3/2+3/2 NC-NO 4 = 5/3 o.c. 8 = 3/2+3/2 NO-NO 5 = 5/3 p.c.

Coils and connectors not included, to be purchased separately

4 Control 14	5 Return 12	6 Options
3 = Pneumatic amplified 4 = Electrical amplified only DC 5 = Electrical amplified DC/AC	0 = Pneumomechanical spring 1 = Mechanical spring 2 = Pneumatic not amplified 3 = Pneumatic amplified	4 = Electrical amplified only DC 5 = Electrical amplified DC/AC 7 = Electrical not amplified only DC 8 = Electrical not amplified DC/AC

c.c. = closed centres o.c. = open centres p.c. = pressurized centres

U05 Coils side 15 mm

Part No.	Nominal voltage		Frequency	Power consumption			
	V DC	V AC		DC W		AC VA	
			HZ	hold	speed-up	hold	speed-up
DD-040	-	24	50/60	-	-	2,3	3,2
DD-041	12	-	-	2	2	-	-
DD-050	-	48	50/60	-	-	2,3	3,2
DD-051	24	-	-	2	2	-	-
DD-060	-	110	50/60	-	-	2,3	3,2
DD-070	-	230	50/60	-	-	2,3	3,2

Nominal flow rate (NI/min)

BD 18 mm	VDMA-ISO			Oversized		
	Ø4	Ø6	Ø8	Ø4	Ø6	Ø8
5/2	200	440	620	200	480	800
5/3	200	440	580	200	460	720
3/2+3/2	200	440	600	200	460	720

BD 26 mm	VDMA-ISO				Oversized			
	Ø6	Ø8	Ø10	Ø12	Ø6	Ø8	Ø10	Ø12
5/2	500	950	1200	1250	500	1050	1500	1700
5/3	500	900	1100	1150	500	1050	1300	1400
3/2+3/2	500	950	1150	1250	500	1050	1450	1650

BDE Electrical impulse - Solenoid valve with integrated electrical connection

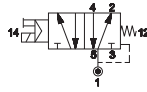
■ Single impulse



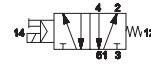
18 mm



26 mm



BDE-324024 18 mm
BDE-424024 26 mm



BDE-324124 18 mm
BDE-424124 26 mm

■ Double impulse



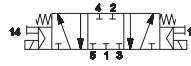
18 mm



26 mm



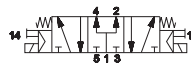
BDE-324424 18 mm
BDE-424424 26 mm



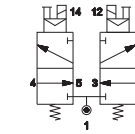
BDE-334424 18 mm
BDE-434424 26 mm



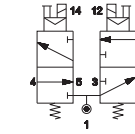
BDE-344424 18 mm
BDE-444424 26 mm



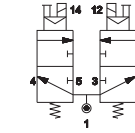
BDE-354424 18 mm
BDE-454424 26 mm



BDE-364424 18 mm
BDE-464424 26 mm



BDE-374424 18 mm
BDE-474424 26 mm



BDE-384424 18 mm
BDE-484424 26 mm

BDB Electrical impulse - Solenoid valve with connector M12

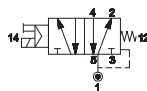
■ Single impulse



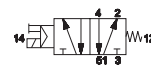
18 mm



26 mm



BDB-324024 18 mm
BDB-424024 26 mm



BDB-324124 18 mm
BDB-424124 26 mm

■ Double impulse



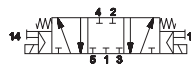
18 mm



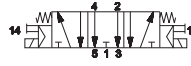
26 mm



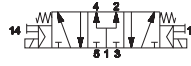
BDB-324424 18 mm
BDB-424424 26 mm



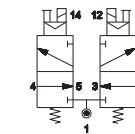
BDB-334424 18 mm
BDB-434424 26 mm



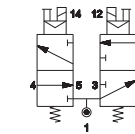
BDB-344424 18 mm
BDB-444424 26 mm



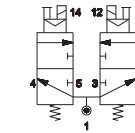
BDB-354424 18 mm
BDB-454424 26 mm



BDB-364424 18 mm
BDB-464424 26 mm



BDB-374424 18 mm
BDB-474424 26 mm



BDB-384424 18 mm
BDB-484424 26 mm

BDA Pneumatic impulse

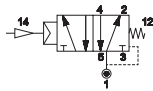
■ Single/double impulse



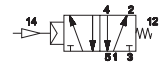
18 mm



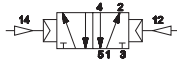
26 mm



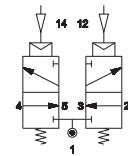
BDA-3230 18 mm
BDA-4230 26 mm



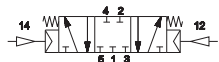
BDA-3231 18 mm
BDA-4231 26 mm



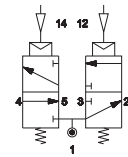
BDA-3233 18 mm
BDA-4233 26 mm



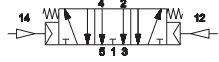
BDA-3633 18 mm
BDA-4633 26 mm



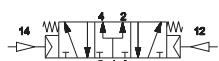
BDA-3333 18 mm
BDA-4333 26 mm



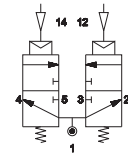
BDA-3733 18 mm
BDA-4733 26 mm



BDA-3433 18 mm
BDA-4433 26 mm



BDA-3533 18 mm
BDA-4533 26 mm



BDA-3833 18 mm
BDA-4833 26 mm

BDA Electrical impulse - External electrical connection

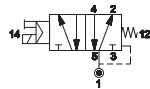
■ Single impulse



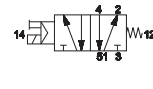
18 mm



26 mm



BDA-3240 18 mm
BDA-4240 26 mm



BDA-3241 18 mm
BDA-4241 26 mm

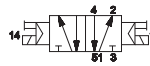
■ Double impulse



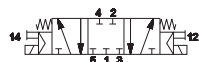
18 mm



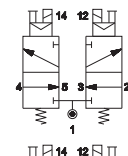
26 mm



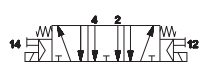
BDA-3244 18 mm
BDA-4244 26 mm



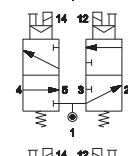
BDA-3344 18 mm
BDA-4344 26 mm



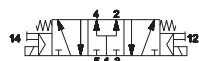
BDA-3644 18 mm
BDA-4644 26 mm



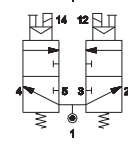
BDA-3444 18 mm
BDA-4444 26 mm



BDA-3744 18 mm
BDA-4744 26 mm



BDA-3544 18 mm
BDA-4544 26 mm



BDA-3844 18 mm
BDA-4844 26 mm



DIN C (8 mm)

For further information please contact our Sales Office.

BDE Manifold sub-bases - Integrated electrical connection

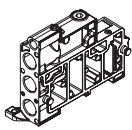
■ 18 mm

■ 26 mm

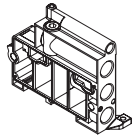


18 mm

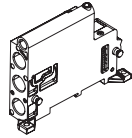
BDF-3100 BDF-3115 BDF-3120 BDF-3140TIM BDF-3180 BDF-3185 BDF-3190



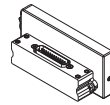
left supply plate G3/8



right supply plate G3/8



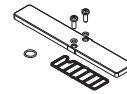
intermediate supply plate G3/8



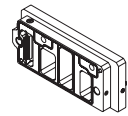
multipolar male connection module: 25 poles, type D



pressure separator

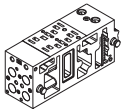


closing plate for unused valve place

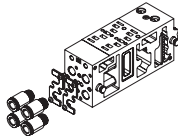


connecting interface for valves side 18-26 mm

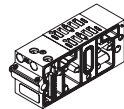
BDF-3210 BDF-3230 (a) BDF-3310 BDF-3330 (a) BDF-3400 GZR-100 GZR-V10004/06/08



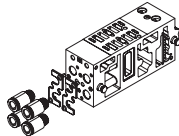
two-place sub-base in compliance with VDMA-ISO flow rate 620 NI/min



two-place sub-base in compliance with VDMA-ISO flow rate 620 NI/min fittings Ø 4-6-8 mm



two-place sub-base with increased flow rate 800 NI/min



two-place sub-base with increased flow rate 800 NI/min fittings Ø 4-6-8 mm



single one-place sub-base with increased flow rate



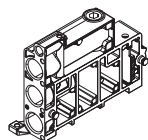
blanking plug



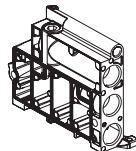
UNIVER designed fittings
GZR-V10004 Ø4 mm
GZR-V10006 Ø6 mm
GZR-V10008 Ø8 mm

26 mm

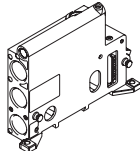
BDF-4100 BDF-4115 BDF-4120 BDF-4140TIM BDF-4180 BDF-4185



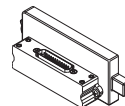
left supply plate G1/2



right supply plate G1/2



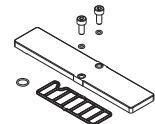
intermediate supply plate G1/2



multipolar male connection module: 25 poles, type D

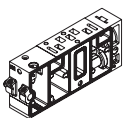


plate for separating supply pressures

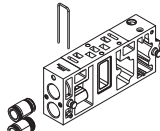


closing plate for unused valve place

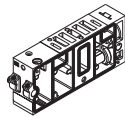
BDF-4210/20 BDF-4230 (a) BDF-4310/20 BDF-4330/31/32 (a) BDF-4400 GZR-VV1006/08/10



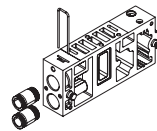
one-place sub-base in compliance with VDMA-ISO flow rate 1250 NI/min
BDF-4210 G1/4 connections
BDF-4220 G3/8 connections



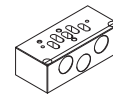
one-place sub-base in compliance with VDMA-ISO flow rate 1250 NI/min fittings Ø 6-8-10 mm



one-place sub-base with increased flow rate 1700 NI/min
BDF-4310 G1/4 connections
BDF-4320 G3/8 connections



one-place sub-base with increased flow rate 1700 NI/min fittings Ø 6-8-10 mm



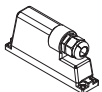
single one-place sub-base with increased flow rate



UNIVER designed fittings
GZR-VV1006 Ø6 mm
GZR-VV1008 Ø8 mm
GZR-VV1010 Ø10 mm

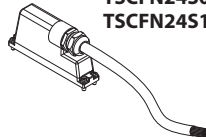
Electrical connections

TSCFN24S000

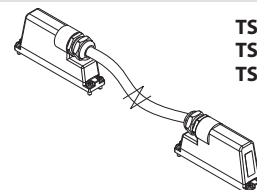


female connector 25 poles sub-D type
no cable - M3x8 fixing screws

**TSCFN24S0300
TSCFN24S0500
TSCFN24S1000**



female connector: 25 poles, sub-D type,
prewired for 26 coils (3-5-10m length)
M3x8 fixing screws



sub-D type male/female flying connector (upon request)
prewired for 16 coils with cable Ø 8 mm (3-5-10 m length)
suitable for dynamic laying - M3 x 8 fixing screws

(a) = sub-base including fixing plate for fittings (fittings excluded)

BDA/BDB Manifold sub-bases - Electrical connection with external connector

■ 18 mm

■ 26 mm



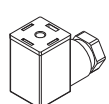
18 mm

BDF-3110	BDF-3115	BDF-3125	BDF-3180	BDF-3185	BDF-3191	BDF-3400
left supply plate G3/8	right supply plate G3/8	intermediate supply plate G3/8	pressure separator	closing plate for unused valve place	interface for connecting valves side 18-26 mm	single one-place sub-base with increased flow rate
BDF-3211/2 (b)	BDF-3231/2 (a) - (b)	BDF-3311/2 (b)	BDF-3331/2 (a) - (b)	GZR-100	GZR-V10004/6/8	DD-...
two-place sub-base in compliance with VDMA-ISO flow rate 620 NI/min G1/8 connections	two-place sub-base in compliance with VDMA-ISO flow rate 620 NI/min fittings Ø 4-6-8 mm	two-place sub-base with increased flow rate 800 NI/min G1/8 connections	two-place sub-base with increased flow rate 800 NI/min fittings Ø 4-6-8 mm	blanking plug	UNIVER designed fittings GZR-V10004 Ø4 mm GZR-V10006 Ø6 mm GZR-V10008 Ø8 mm	U05 coil side 15 mm

26 mm

BDF-4110	BDF-4115	BDF-4125	BDF-4180	BDF-4185	BDF-4400
left supply plate G1/2	right supply plate G1/2	intermediate supply plate G1/2	pressure separator	closing plate for unused valve place	single one-place sub-base with increased flow rate
BDF-4211/.. (b)	BDF-4231/2 (a) - (b)	BDF-4311/.. (b)	BDF-4331/2 (a) - (b)	GZR-VV1006/8/10	DD-...
one-place sub-base in compliance with VDMA-ISO flow rate 1250 NI/min G1/4 connect. G3/8 connect. BDF-4211 BDF-4221 BDF-4212 BDF-4222	one-place sub-base in compliance with VDMA-ISO flow rate 1250 NI/min fittings Ø 6-8-10 mm BDF-4231 BDF-4232	one-place sub-base with increased flow rate 1700 NI/min G1/4 connect. G3/8 connect. BDF-4311 BDF-4321 BDF-4312 BDF-4322	one-place sub-base with increased flow rate 1700 NI/min fittings Ø 6-8-10 mm	UNIVER designed fittings GZR-VV1006 Ø6 mm GZR-VV1008 Ø8 mm GZR-VV1010 Ø10 mm	U05 coil side 15 mm

Electrical connections



AM-5109

15 mm connector

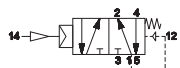
(a) = sub-base including fixing plate for fittings (fittings excluded)
 (b) = part no. ending: 1 = electrical non integrated 2 = only pneumatic

CHARACTERISTICS

Ambient temperature	-10 ÷ +45 °C
Fluid	50 µm filtered air, with or without lubrication
Commutation system	poppet mixed
Max pressure	10 bar
Connections	G1/4 (1-3-5), NAMUR interface (2-4)
Nominal bore (mm)	8
Nominal flow rate (NI/min)	1200
Valve body	zamak
Seals	NBR, polyurethane
Spool	aluminium
Electropilot/Coil	AA series/U1-U3
Power consumption	3,5 W (DC), 5 VA (AC)
Connector	AM-5110
Voltage	2 V DC - 24 V DC - 24 V AC - 110 V AC - 230 V AC
Manual override	impulse screw - 2 positions

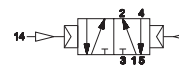

Pneumatic impulse

■ Single impulse



AC-N8100

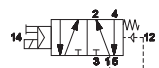
■ Double impulse



AC-N8120

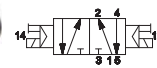
Electrical impulse

■ Single impulse



AC-N8500

■ Double impulse



AC-N8520

Version 3/2: valves are supplied with proper flat plug for closing unused way
 Solenoid valves are supplied without coil / connector / locking nut

■ AC-N8500 with YR2 actuator



CHARACTERISTICS

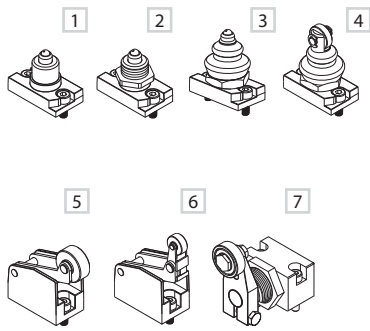
Ambient temperature	-10 ÷ +45 °C	
Fluid	50 µm filtered air, with or without lubrication	
Commutation system	spool	
Max pressure	10 bar	
Connections	G1/8	G1/4
Nominal bore (mm)	6,5	8,5
Nominal flow rate (NI/min)	890	1480
Valve body	die-cast zamak (G1/8), aluminium (G1/4)	
Seals	NBR	
Spool	aluminium	
Electropilot/Coil	AA series/U1-U3	
Power consumption	3,5W (DC) - 5 VA (AC)	
Connector	AM-5110	
Voltage	12 V DC - 24 V DC - 24 V AC - 110 V AC - 230 V AC	
Manual override	impulse screw - 2 positions	



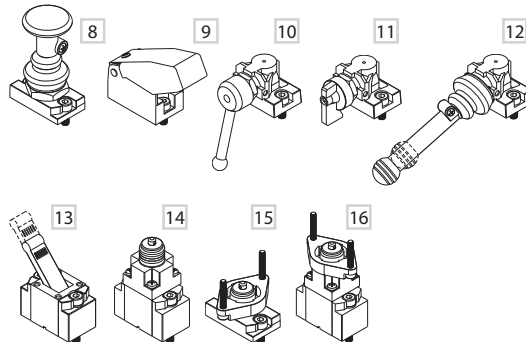
NOTE: some versions with high temperature seals are available upon request (for further information please contact our Sales Office)

UNIVERSAL Modular System

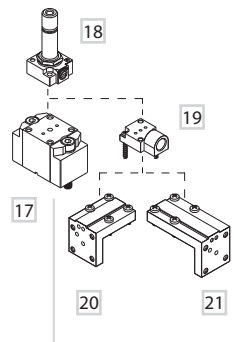
MECHANICAL



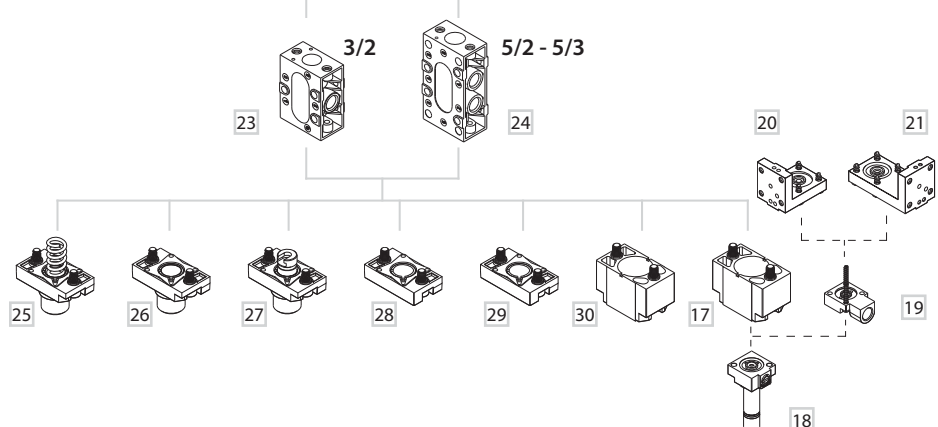
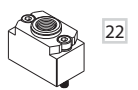
MANUAL



ELECTRICAL



PNEUMATIC



MECHANICAL CONTROL

- 1 Ball push
- 2 Ball push for screw panel mounting
- 3 Ball push with dust protection
- 4 Roller with dust protection
- 5 Roller lever
- 6 One-way roller lever
- 7 Two-way side roller lever

MANUAL CONTROL

- 8 Push-pull
- 9 Push button
- 10 Rotating lever
- 11 Selector

- 12 90° short/long lever

- 13 Short/long lever
- 14 Threaded indirect operation
- 15 Panel direct operation
- 16 Panel indirect operation

ELECTRICAL CONTROL

- 17 Electrical amplified
- 18 U1 electropilot
- 19 Plate for external pilot supply
- 20 Angle plate for "H" solenoid option
- 21 Angle plate for "P" solenoid option

PNEUMATIC CONTROL

- 22 Pneumatic amplified

BODY

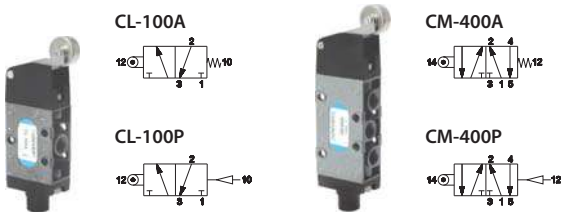
- 23 3/2 body
- 24 5/2 body

RETURN

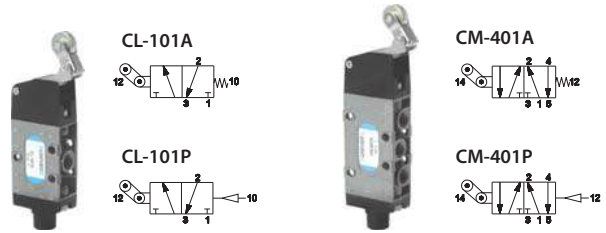
- 25 Mechanical spring
- 26 Pneumatic not amplified
- 27 Bottom plate - 2/3 positions
- 28 Bottom plate
- 29 Pneumatic spring
- 30 Pneumatic amplified

Valves G1/8 with direct mechanical operation

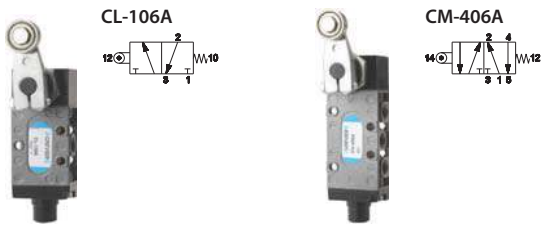
■ Roller lever



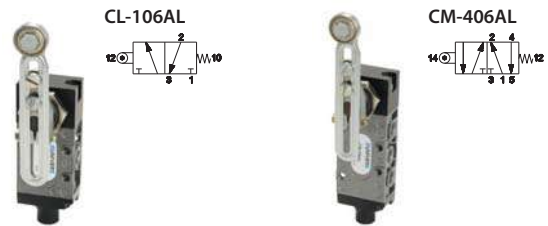
■ One-way roller lever



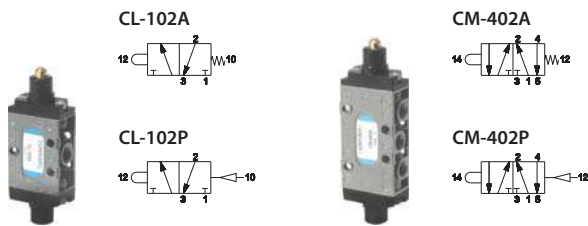
■ NEW - Two-way side roller lever



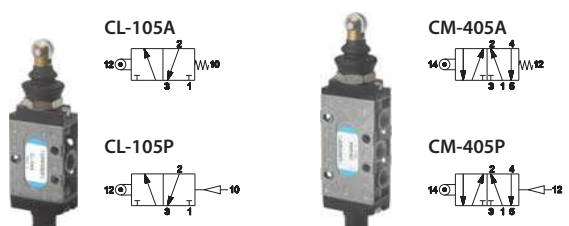
■ NEW - Adjustable two-way side roller lever



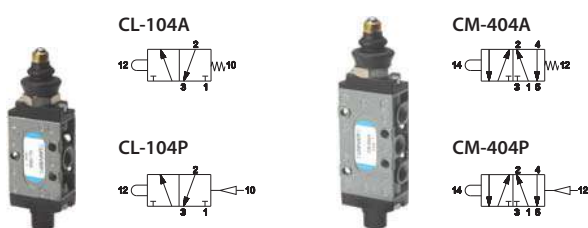
■ Ball-push



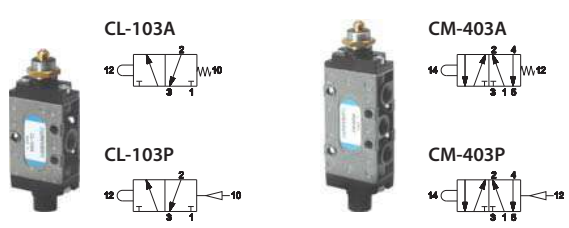
■ Roller with dust protection



■ Ball push with dust protection

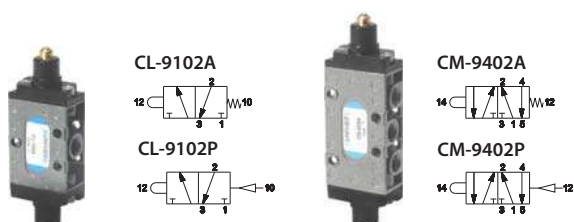


■ Ball push for screw panel mounting

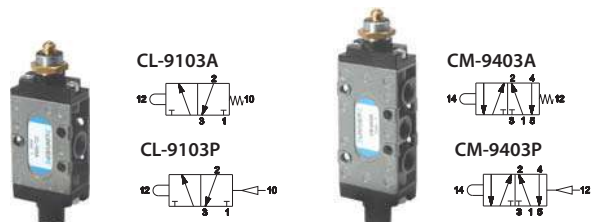


Valves G1/4 with direct mechanical operation

■ Ball push



■ Ball push for screw panel mounting



Valves G1/8 - G1/4 with indirect mechanical operation for pneumatic and mechanical operators

Ball push				Sensible ball push			
	CL-110A G 1/8				CL-111A G 1/8		
	CL-9110A G 1/4				CL-9111A G 1/4		
	CL-110P G 1/8				CL-111P G 1/8		
	CL-9110P G 1/4				CL-9111P G 1/4		
	CM-410A G 1/8				CM-411A G 1/8		
	CM-9410A G 1/4				CM-9411A G 1/4		
	CM-410P G 1/8				CM-411P G 1/8		
	CM-9410P G 1/4				CM-9411P G 1/4		

AI-3550	AI-3551	AI-3560	AI-3562	AI-3563	AI-3570	AI-3571	AI-3572	AI-3511	AI-3514	AI-3515	AI-3520	AI-3522	AI-3524	AI-3525	AI-3526
								AI-3512	AI-3516	AI-3517	AI-3521	AI-3523			
								AI-3513	AI-3514D	AI-3519					
								AI-3516D							

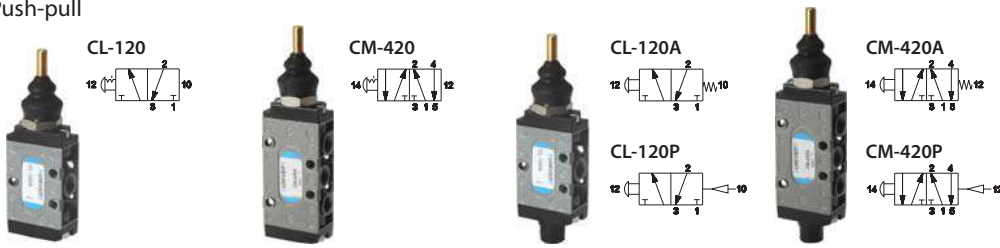
Valves G1/8 - G1/4 with direct and indirect operation for panel operators

Ball push (direct operation)				Ball push (indirect operation)			
	CL-112A				CL-113A G 1/8		
	CL-9113A G 1/4				CL-9113P G 1/4		
	CL-112P				CL-113P G 1/8		
	CL-9113P G 1/4				CL-9113P G 1/4		
	CM-412A				CM-413A G 1/8		
	CM-9413A G 1/4				CM-413P G 1/8		
	CM-412P				CM-9413P G 1/4		
	CM-9413P G 1/4				CM-9413P G 1/4		

AI-3511Q	AI-3514Q	AI-3515Q	AI-3524Q	AI-3511Q	AI-3514Q	AI-3515Q	AI-3520Q	AI-3524Q	AI-3522Q	AI-3525Q	AI-3526Q
AI-3512Q	AI-3516Q	AI-3517Q		AI-3512Q	AI-3516Q	AI-3517Q	AI-3521Q		AI-3523Q		
AI-3513Q	AI-3514QD	AI-3519Q		AI-3513Q	AI-3514QD	AI-3519Q					
AI-3516QD				AI-3516QD							

Valves G1/8 with manual operation

■ Push-pull

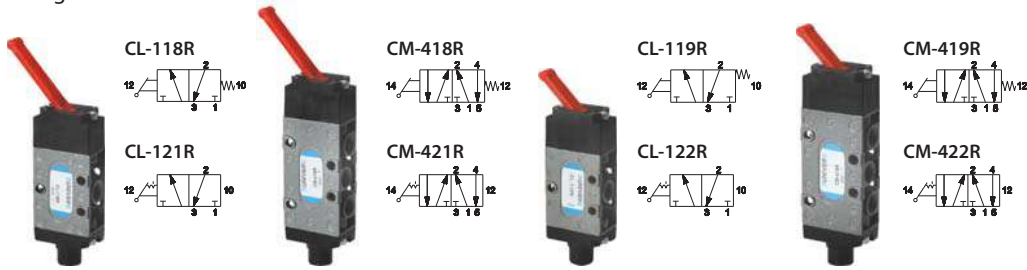


- YELLOW
CP-911G
- RED
CP-911R
- BLACK
CP-911N
- GREEN
CP-911V

Valves are supplied without operator

■ Long lever

■ Short lever



LONG LEVER

STANDARD

- RED

UPON REQUEST

- YELLOW
- BLACK

SHORT LEVER

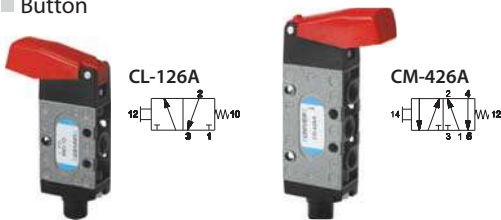
STANDARD

- RED

UPON REQUEST

- YELLOW
- BLACK
- GREEN

■ Button



STANDARD

- RED

■ Rotating lever



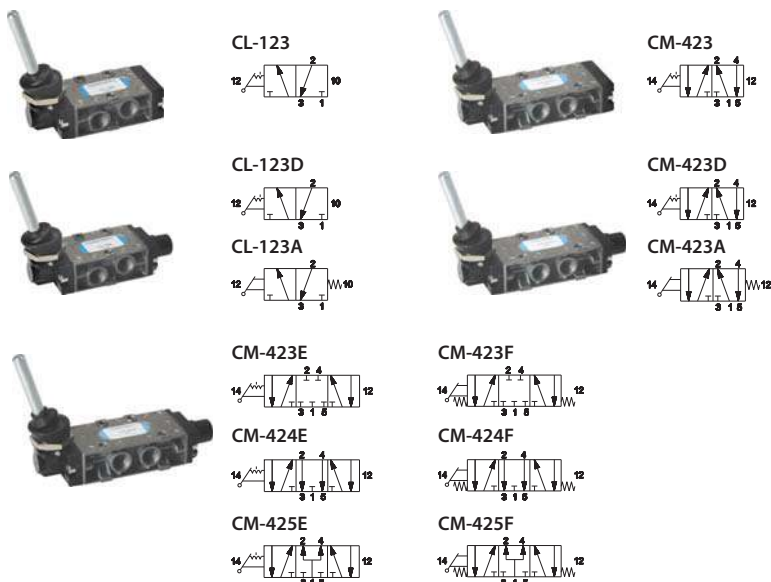
- RED
CP-915R



- RED
CP-916R

Valves are supplied without operator

■ 90° Lever



LONG LEVER



- RED
CP-913R

SHORT LEVER



- YELLOW
CP-912G
- RED
CP-912R
- BLACK
CP-912N

Valves are supplied without operator

Valves G1/4 with manual operation

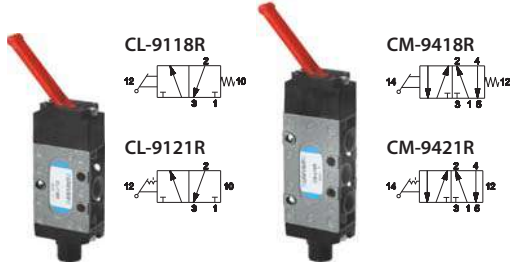
■ Push-pull



- YELLOW CP-911G
- RED CP-911R
- BLACK CP-911N
- GREEN CP-911V

Valves are supplied without operator

■ Long lever



- STANDARD
■ RED

- UPON REQUEST
■ YELLOW
■ BLACK

■ Rotating lever



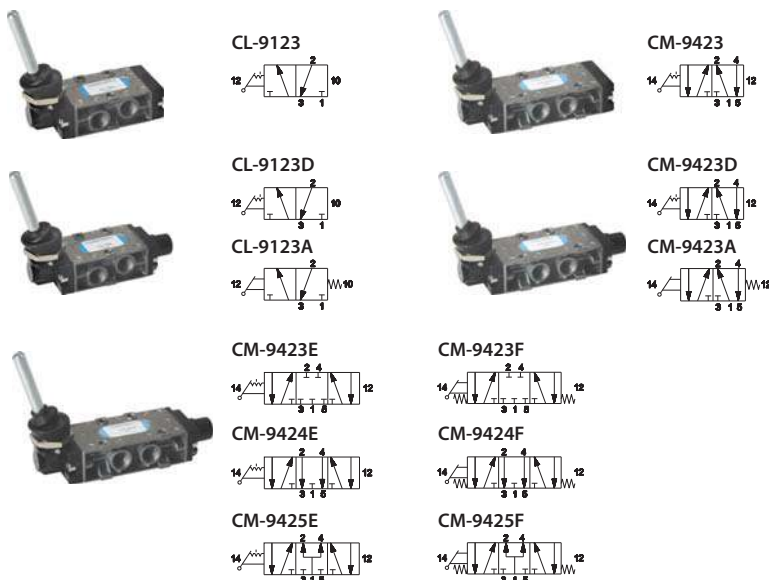
- RED CP-915R



- RED CP-916R

Valves are supplied without operator

■ 90° Lever



LONG LEVER



- RED CP-913R

SHORT LEVER


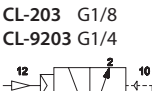





- YELLOW CP-912G
- RED CP-912R
- BLACK CP-912N







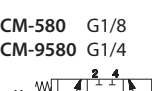
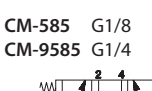
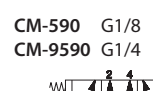
Valves are supplied without operator

Valves G1/8 - G1/4 with pneumatic operation

■ Single impulse


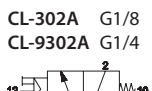




	CL-200 G1/8 CL-9200 G1/4		CL-203 G1/8 CL-9203 G1/4		CL-200A G1/8 CL-9200A G1/4
	CM-500 G1/8 CM-9500 G1/4		CM-500A G1/8 CM-9500A G1/4		

■ Double impulse


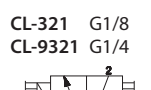


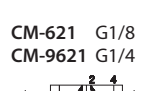

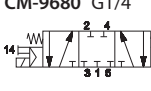
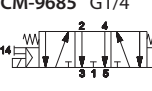
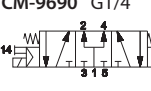
	CL-220 G1/8 CL-9220 G1/4		CL-221 G1/8 CL-9221 G1/4		CL-224 G1/8 CL-9224 G1/4
	CM-521 G1/8 CM-9521 G1/4		CM-524 G1/8 CM-9524 G1/4		
	CM-520 G1/8 CM-9520 G1/4		CM-580 G1/8 CM-9580 G1/4		CM-585 G1/8 CM-9585 G1/4
					CM-590 G1/8 CM-9590 G1/4

Valves G1/8 - G1/4 with electrical operation

■ Single impulse

	CL-300 G1/8 CL-9300 G1/4		CL-302A G1/8 CL-9302A G1/4		CL-301 G1/8 CL-9301 G1/4
	CL-303A G1/8 CL-9303A G1/4		CM-600 G1/8 CM-9600 G1/4		CM-602A G1/8 CM-9602A G1/4

■ Double impulse

	CL-320 G1/8 CL-9320 G1/4		CL-321 G1/8 CL-9321 G1/4		CL-322 G1/8 CL-9322 G1/4
	CM-620 G1/8 CM-9620 G1/4		CM-621 G1/8 CM-9621 G1/4		CM-622 G1/8 CM-9622 G1/4
	CM-680 G1/8 CM-9680 G1/4		CM-685 G1/8 CM-9685 G1/4		CM-690 G1/8 CM-9690 G1/4

Solenoid valves are supplied without coil, connector and locking nut

AM-5148

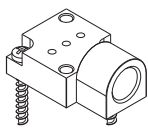
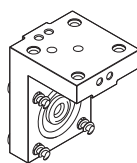


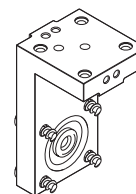
Plate for external pilot supply

AM-5151



Angle plate for "H" solenoid option

AM-5152



Angle plate for "P" solenoid option

CLIPS Modular sub-base G1/8 - G1/4 for 3/2 - 5/2 - 5/3 valves

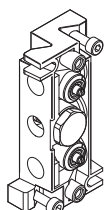


G1/8



G1/4

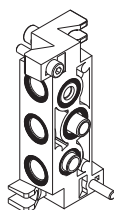
CP-100/CP-9100



modular sub-base with adjustable and conveyed exhausts
CP-100 for G1/8, CP-9100 for G1/4
material: zamak

standard supplied: screws, seals, exhaust regulator and coupling for valve fixing

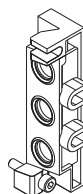
CP-101/CP-9101



modular sub-base without adjustable exhausts
CP-101 for G1/8, CP-9101 for G1/4
material: zamak

standard supplied: screws, seals and coupling for valve fixing

CP-105/CP-9105



side connection inlet plate
CP-105 G1/4, CP-9105 G3/8
material: zamak

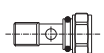
standard supplied: screws and seals

CP-106



closing plate for unused place
material: aluminium

CP-110/CP-9110



coupling
connections: CP-110 G1/8, CP-9110 G1/4
material: brass

CP-111/CP-9111



pressure separator
CP-111 for G1/8, CP-9111 for G1/4
material: aluminium

CP-112/CP-9112



plug for 3/2 valve mounting
CP-112 for G1/8, CP-9112 for G1/4
material: aluminium

CP-113/CP-9113

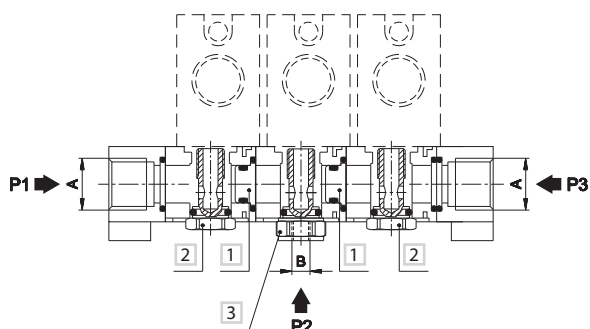


adjustment needle
CP-113 for G1/8, CP-9113 for G1/4
material: brass

For each additional pressure, one coupling and two separators are required

Plug for mounting 3/2 NC-NO valves on "CLIPS" sub-base to close unused way. Sub-base with adjustment screw (screwdriver slot) standard supplied. Upon request: adjustment needle with milled handle

Assembly Example
Manifold supplied by three different pressures



	A	B
G1/8	G1/4	G1/8
G1/4	G3/8	G1/4

- 1 Pressure separator CP-111/CP-9111
- 2 Fixing coupling for valve embodied in the sub-base
- 3 Coupling CP-110/CP-9110

CHARACTERISTICS

Ambient temperature	-10 ÷ +45 °C
Fluid	10 µm filtered air
Commutation system	spool
Max pressure	10 bar
Connections	M5, for sub-base
Nominal bore (mm)	2
Nominal flow rate (NI/min)	150
Valve body	zamak
Seals	NBR
Electropilot/Coil	A series/U05
Voltage	24 V DC - 12 V DC - 24 V AC - 110 V AC - 230 V AC



CODIFICATION KEY

E	-	0	2	2	4
1		2	3	4	

1 Series	2 Type	3 Control 14	4 Return 12
E = COMPA 2 Miniature Valves	02 = 5/2 Sub-base mounting 04 = 5/2 Threaded body M5 05 = 5/3 c.c. Sub-base mounting 06 = 5/3 o.c. Sub-base mounting 07 = 5/3 p.c. Sub-base mounting 08 = 5/3 c.c. Threaded body M5 09 = 5/3 o.c. Threaded body M5 10 = 5/3 p.c. Threaded body M5	2 = Electrical DC 4 = Pneumatic 7 = Electrical DC/AC	0 = Pneumomechanical spring 2 = Electrical DC 4 = Pneumatic impulse 7 = Electrical DC/AC

c.c. = closed centres o.c. = open centres p.c. = pressurized centres

Pneumatic impulse

Single impulse	Double impulse
<p>E-0240</p>	<p>E-0244</p>

Electrical impulse

Single impulse	Double impulse
<p>E-0220 E-0270</p>	<p>E-0222 E-0277 E-0522 E-0622 E-0722</p>

Inlet plate G1/8

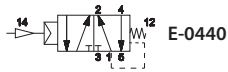
Manifold sub-base, side connections M5

<p>E-4500</p>	<p>E-4505</p>
---------------	---------------

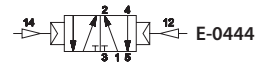
Solenoid valves are supplied without coil and connector

Pneumatic impulse - 5/2 Valves M5

■ Single impulse

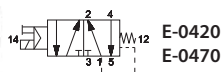


■ Double impulse

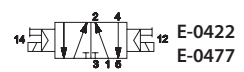


Electrical impulse - 5/2 Valves M5

■ Single impulse

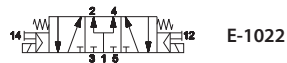
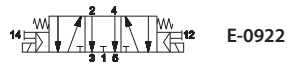
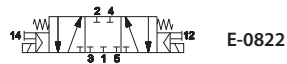


■ Double impulse



Electrical impulse - 5/3 Valves M5

■ Double impulse



DIN C (8 mm)

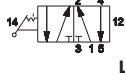
For further information please contact our Sales Office

Solenoid valves are supplied without coil and connector

5/2 Valves M5 - Mechanical and manual operation

3

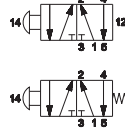
■ Lever valve



LEVER

- E-15422G ■ YELLOW
- E-15422N ■ BLACK
- E-15422R ■ RED

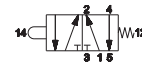
■ Push-pull valve



E-15420

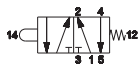
E-15420A

■ Ball push valve



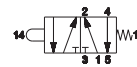
E-15402A

■ Ball push valve for mechanical screw operation



E-15403A

■ Ball push valve for mechanical panel operation



E-15412A

AI-3550	AI-3551	AI-3560	AI-3562	AI-3563	AI-3570	AI-3571	AI-3572	AI-3511Q ■	AI-3514Q ■	AI-3515Q ■	AI-3520Q ■	AI-3524Q ■	AI-3522Q ■	AI-3525Q ■	AI-3526Q ■
								AI-3512Q ■	AI-3516Q ■	AI-3517Q ■	AI-3521Q ■				
								AI-3513Q ■	AI-3514QD ■	AI-3519Q ■					
								AI-3516QD ■							
AI-3511 ■	AI-3514 ■	AI-3515 ■	AI-3520 ■	AI-3522 ■	AI-3524 ■	AI-3525 ■	AI-3526 ■								
AI-3512 ■	AI-3516 ■	AI-3517 ■	AI-3521 ■	AI-3523 ■											
AI-3513 ■	AI-3514D ■	AI-3519 ■													
	AI-3516D ■														

CHARACTERISTICS

Ambient temperature	-10 ÷ +45 °C
Fluid	10 µm filtered air
Commutation system	spool
Max pressure	10 bar
Connections	for sub-base
Nominal bore (mm)	4
Nominal flow rate (NI/min)	390
Valve body	acetalic resin
Seals	NBR
Electropilot/Coil	A series/U05
Voltage	24 V DC - 12 V DC - 24 V AC - 110 V AC - 230 V AC



CODIFICATION KEY

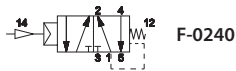
F	-	0	2	2	4
1		2	3	4	

1 Series	2 Type	3 Control 14	4 Return 12
F = COMPA 4 Miniature Valves	02 = 5/2 Sub-base mounting 05 = 5/3 c.c. Sub-base mounting 06 = 5/3 o.c. Sub-base mounting 07 = 5/3 p.c. Sub-base mounting	2 = Electrical DC 4 = Pneumatic 7 = Electrical DC/AC	0 = Pneumomechanical spring 2 = Electrical DC 4 = Pneumatic impulse 7 = Electrical DC/AC

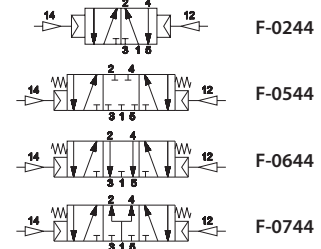
c.c. = closed centres o.c. = open centres p.c. = pressurized centres

Pneumatic impulse

■ Single impulse

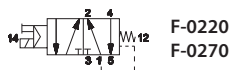


■ Double impulse

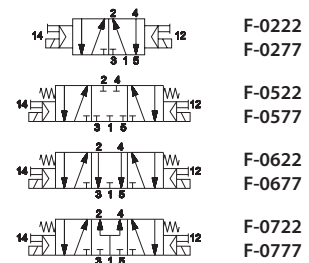


Electrical impulse

■ Single impulse



■ Double impulse



DIN C (8 mm)
For further information please contact our Sales Office

Inlet plate G1/8



F-4500

Manifold sub-base, threaded connections G1/8



F-4505

Solenoid valves are supplied without coil and connector

CHARACTERISTICS

Ambient temperature	-5 ÷ +50 °C
Fluid	50 µm filtered air, with or without lubrication
Commutation system	spool
Pressure	1,5 ÷ 9 bar
Nominal bore (mm)	5
Nominal flow rate (NI/min)	770 (5/2) 700 (5/3) 670 (3/2+3/2)
Connections	G1/8
Valve body	zamak
Seals	NBR
Spool	aluminium
Electropilot/Coil	A series/U05 - B series/U04
Voltage	24 V DC - 12 V DC - 24 V AC - 110 V AC - 230 V AC (only for version with integrated electrical connection)
Power consumption	U05 = 2 W (DC) 2,3 VA (AC) U04 = 1,2 W (DC)
Manual override	recessed button - 1 position



CODIFICATION KEY

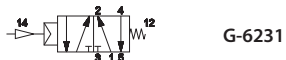
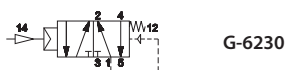
G	-	6	6	4	4	
1	2	3	4	5		

1 Series	2 Type	3 Control 14
G-6 = 20 mm - Valves and solenoid valves threaded body G1/8	2 = 5/2 3 = 5/3 c.c. 4 = 5/3 o.c. 5 = 5/3 p.c.	3 = Pneumatic amplified 4 = Electrical amplified DC 5 = Electrical amplified DC/AC 6 = Electrical amplified DC - B series 10 mm electropilot
4 Return 12	5 Option	
0 = Pneumomechanical spring 1 = Mechanical spring 3 = Pneumatic amplified	4 = Electrical amplified DC 5 = Electrical amplified DC/AC 6 = Electrical amplified DC - B series 10 mm electropilot	D = External pilot supply

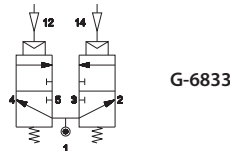
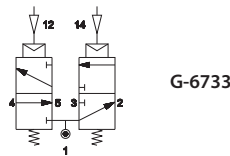
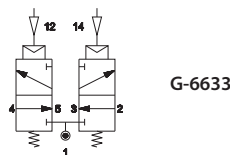
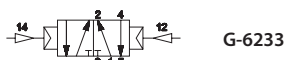
c.c. = closed centres o.c. = open centres p.c. = pressurized centres

Pneumatic impulse

Single impulse



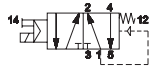
Double impulse



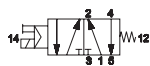
Solenoid valves are supplied without coil and connector

Electrical impulse - A series 15 mm Electropilot

■ Single impulse



G-6240 DC
G-6250 AC/DC



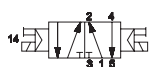
G-6241 DC
G-6251 AC/DC



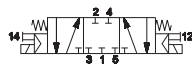
Coil with intergrated connector for multipolar version
DD-051-2C 24 V DC
DD-040-2C 24 V AC

Single/double impulse

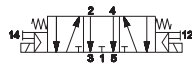
■ Double impulse



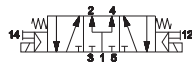
G-6244 DC
G-6255 AC/DC



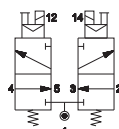
G-6344 DC
G-6355 AC/DC



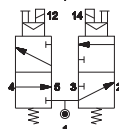
G-6444 DC
G-6455 AC/DC



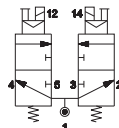
G-6544 DC
G-6555 AC/DC



G-6644 DC
G-6655 AC/DC



G-6744 DC
G-6755 AC/DC



G-6844 DC
G-6855 AC/DC

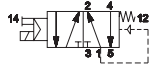


DIN C (8 mm)

For further information please contact our Sales Office

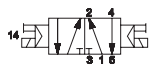
Electrical impulse - B series 10 mm Electropilot

■ Single impulse

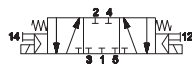


G-6260
G-6261

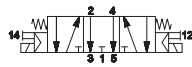
■ Double impulse



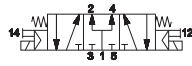
G-6266



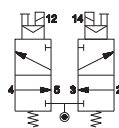
G-6366



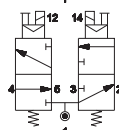
G-6466



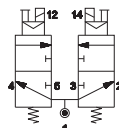
G-6566



G-6666



G-6766



G-6866

Solenoid valves are supplied without coil and connector

Electrical sub-base

■ Multipolar connection

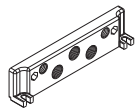
■ External connection

■ Connector with loose cables

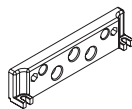
3



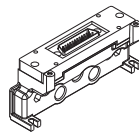
GP-6100 **GP-6110** **GP-611212** **GP-611806** **GP-6310/1/2** **GP-6320/1/2**



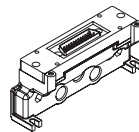
threaded end plate



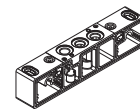
blank end plate



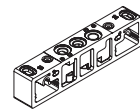
threaded end plate with male connector
25 poles
12+12 coils control 12-14



threaded end plate with male connector
25 poles
18 coils control 14
6 coils control 12

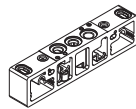


sub-base with open diaphragms
GP-6310 without electrical connection
GP-6311 monostable
GP-6312 bistable

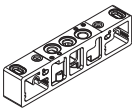


sub-base with closed diaphragms
GP-6320 without electrical connection
GP-6321 monostable
GP-6322 bistable

GP-6330/1/2 **GP-6340/1/2** **GP-6380** **GP-6385** **GP-6400-1** **GP-6400-2** **GP-6400-5**



3 1 5
sub-base with closed air supply and open exhausts
GP-6330 without electrical connection
GP-6331 monostable
GP-6332 bistable



3 1 5
sub-base with open air supply and closed exhausts
GP-6340 without electrical connection
GP-6341 monostable
GP-6342 bistable



intermediate supply plate
(to be used only with GP-63... sub-base)



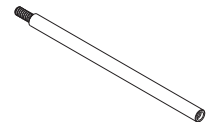
closing plate for unused valve place



modular tie-rod
1 valve place



modular tie-rod
2 valve places



modular tie-rod
5 valve places

AZ4-SN004A

No. 100 hexagonal nuts M4

AZ4-VN0416

No. 100 allen screws M4x16 for tie rods

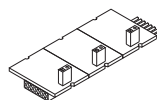
GP-6512-01/..MF **GP-6514-01/..MF** **GP-651418** **DD-...** **DD-051-2C/DD-040-2C** **DE-6521**



BUS connection card control side 12 with 12 pins
GP-6512-01MF 1 place
GP-6512-02MF 2 places
GP-6512-03MF 3 places
GP-6512-05MF 5 places
GP-6512-06MF 6 places



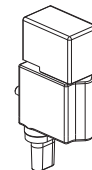
BUS connection card control side 14 with 12 pins
GP-6514-01MF 1 place
GP-6514-02MF 2 places
GP-6514-03MF 3 places
GP-6514-05MF 5 places
GP-6514-06MF 6 places



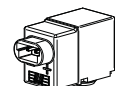
BUS connection card control side 14 with 18 pins (only 12 places) for manifolds with control 14 and more than 12 coils (up to 18) use GP-651418 card 12 places and then GP-6514-...



24 V DC 2 W coil for single connection



24 V DC 2 W coil with integrated connector for multipolar version

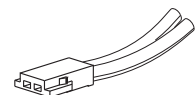


24 V DC 1,35 W coil with in-line connector with protection for a complete tightness

D-530-30/50/200

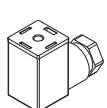
Customized solutions up to 12 places available upon request

Electrical connections



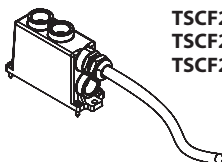
Miniature connector with loose cables

D-530-30 = wire length 300 mm
D-530-50 = wire length 500 mm
D-530-200 = wire length 2000 mm



AM-5109

15 mm connector



TSCF24S0300
TSCF24S0500
TSCF24S1000

sub-D flying female connector in compliance with CEI 20-22 O.R. II prewired for 24 coils (3-5-10 length) M3x12 fixing screws

CHARACTERISTICS

Ambient temperature	-5 ÷ +50 °C
Fluid	50 µm filtered air, with or without lubrication
Commutation system	spool
Pressure	1,5 ÷ 9 bar
Connections	sub-base interface
Nominal bore (mm)	5
Nominal flow rate (NI/min)	140 ÷ 740 (depending on the type of fittings)
Valve body	zamak
Seals	NBR
Spool	aluminium
Electropilot/Coil	A series/U05 - B series/U04
Voltage	24 V DC - 12 V DC - 24 V AC - 110 V AC - 230 V AC (only version with external connection)
Power consumption	U05 = 2 W (DC) 2,3 VA (AC) U04 = 1,2 W (DC)
Manual override	recessed button - 1 position



CODIFICATION KEY

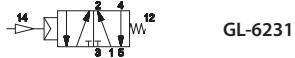
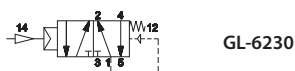
G	L	-	6	6	4	4	
			1	2	3	4	5

1 Series	2 Type	3 Control 14	4 Return 12	5 Option
GL-6 = 20 mm - Valves and Solenoid Valves for sub-base mounting	2 = 5/2 3 = 5/3 c.c. 4 = 5/3 o.c. 5 = 5/3 p.c. 6 = 3/2+3/2 NC-NC 7 = 3/2+3/2 NC-NO 8 = 3/2+3/2 NO-NO	3 = Pneumatic amplified 4 = Electrical amplified DC 5 = Electrical amplified DC/AC 6 = Electrical amplified DC B series 10 mm electropilot	0 = Pneumomechanical spring 1 = Mechanical spring 3 = Pneumatic amplified 4 = Electrical amplified DC 5 = Electrical amplified DC/AC 6 = Electrical amplified DC B series 10 mm electropilot	D = External pilot supply

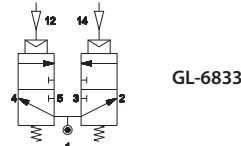
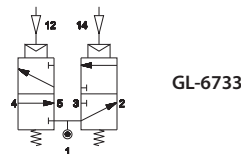
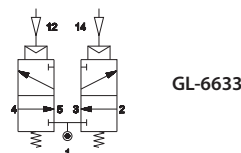
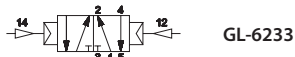
c.c. = closed centres o.c. = open centres p.c. = pressurized centres

Pneumatic impulse

Single impulse



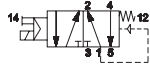
Double impulse



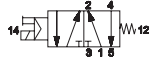
Solenoid valves are supplied without coil and connector

Electrical impulse - A series 15 mm Electropilot

■ Single impulse



GL-6240 DC
GL-6250 AC/DC



GL-6241 DC
GL-6251 AC/DC



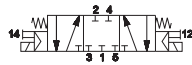
Coil with intergrated connector for multipolar version
DD-051-2C 24 V DC
DD-040-2C 24 V AC

Single/double impulse

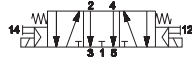
■ Double impulse



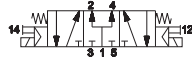
GL-6244 DC
GL-6255 AC/DC



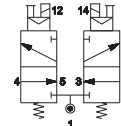
GL-6344 DC
GL-6355 AC/DC



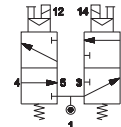
GL-6444 DC
GL-6455 AC/DC



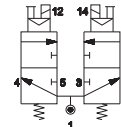
GL-6544 DC
GL-6555 AC/DC



GL-6644 DC
GL-6655 AC/DC



GL-6744 DC
GL-6755 AC/DC



GL-6844 DC
GL-6855 AC/DC

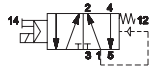


DIN C (8 mm)

For further information please contact our Sales Office

Electrical impulse - B series 10 mm Electropilot

■ Single impulse

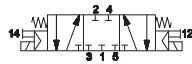


GL-6260
GL-6261

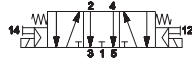
■ Double impulse



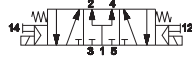
GL-6266



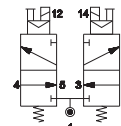
GL-6366



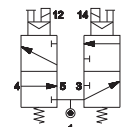
GL-6466



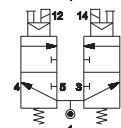
GL-6566



GL-6666



GL-6766



GL-6866

Solenoid valves are supplied without coil and connector

Electrical sub-base

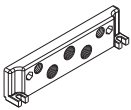
■ Multipolar connection

■ External connection

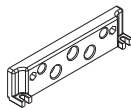
■ Connector with loose cables



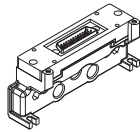
GP-6100 GP-6110 GP-611212 GP-611806 GP-6210/1/2 GP-6220/1/2



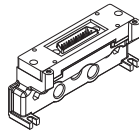
threaded end plate



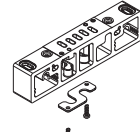
blank end plate



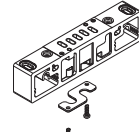
threaded end plate with male connector
25 poles
12+12 coils control 12-14



threaded end plate with male connector
25 poles
18 coils control 14
6 coils control 12

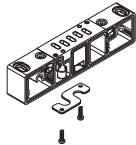


sub-base with open diaphragms
GP-6210 without electrical connection
GP-6211 monostable
GP-6212 bistable



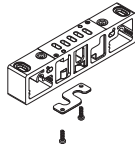
sub-base with closed diaphragms
GP-6220 without electrical connection
GP-6221 monostable
GP-6222 bistable

GP-6230/1/2 GP-6240/1/2 GP-6380 GP-6285 GP-6411



3 1 5

sub-base with closed air supply and open exhausts
GP-6230 without electrical connection
GP-6231 monostable
GP-6232 bistable



3 1 5

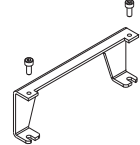
sub-base with open air supply and closed exhausts
GP-6240 without electrical connection
GP-6241 monostable
GP-6242 bistable



intermediate supply plate
(to be used only with GP-63... sub-bases)



closing plate for unused valve place



lifting bracket

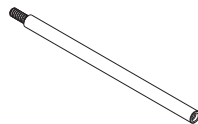
GP-6400-1 GP-6400-2 GP-6400-5 GP-6512-01/..MF GP-6514-01/..MF GP-651418



modular tie-rod
1 valve place



modular tie-rod
2 valve places



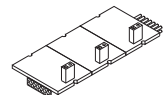
modular tie-rod
5 valve places



BUS connection card control side 12 with 12 pins
GP-6512-01MF 1 place
GP-6512-02MF 2 places
GP-6512-03MF 3 places
GP-6512-05MF 5 places
GP-6512-06MF 6 places



BUS connection card control side 14 with 12 pins
GP-6514-01MF 1 place
GP-6514-02MF 2 places
GP-6514-03MF 3 places
GP-6514-05MF 5 places
GP-6514-06MF 6 places



BUS connection card control side 14 with 18 pins
(only 12 places)
for manifolds with control 14 with more than 12 coils (up to 18) use GP-651418 card 12 places and then GP-6514-...

AZ4-SN004A

No. 100 nuts M4 for tie-rods

AZ4-VN0416

No. 100 screws M4x16 for tie-rods

customized solutions up to 12 places available upon request

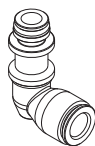
GZR-100 GZR-V10004/6/8 GZR-V20004/6/8 GZR-V20L004/6/8



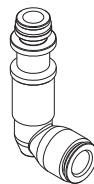
blanking plug



straight fitting
GZR-V10004 tube: 4 mm
GZR-V10006 tube: 6 mm
GZR-V10008 tube: 8 mm



low elbow fitting
GZR-V20004 tube: 4 mm
GZR-V20006 tube: 6 mm
GZR-V20008 tube: 8 mm



high elbow fitting
GZR-V20L004 tube: 4 mm
GZR-V20L006 tube: 6 mm
GZR-V20L008 tube: 8 mm

For sub-bases preset for external pilot supply, add suffix S to part number (e.g. GP-6210S)

DD-...

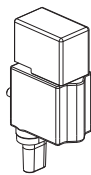
DD-051-2C/DD-040-2C

DE-652I

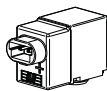
D-530-30/50/200



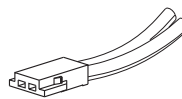
24 V DC 2 W coil for single connection



24 V DC 2 W coil with integrated connector for multipolar version



24 V DC 1,35 W coil with in-line connector with protection for a complete tightness

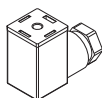


Miniature connector with loose cables

D-530-30 = wire length 300 mm
 D-530-50 = wire length 500 mm
 D-530-200 = wire length 2000 mm

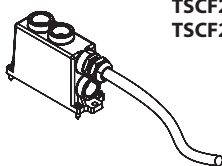
Electrical connections

AM-5109



15 mm connector

TSCF24S0300
 TSCF24S0500
 TSCF24S1000



sub-D flying female connector in compliance with CEI 20-22 O.R. II prewired for 24 coils (3-5-10 m length) M3x12 fixing screws

■ Example of panel mounting



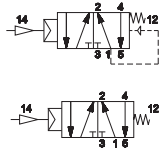
CHARACTERISTICS

Ambient temperature	-10 ÷ +45 °C
Fluid	50 µm filtered air, with or without lubrication
Commutation system	spool
Max pressure	10 bar
Nominal bore (mm)	6
Nominal flow rate (NI/min)	860
Connector	G1/8
Valve body	zamak
Seals	NBR
Spool	aluminium
Electropilot/Coil	AA series/U1-U3
Power consumption	3,5 W (DC), 5 VA (AC)
Connector	AM-5110
Voltage	12 V DC - 24 V DC - 24 V AC - 110 V AC - 230 V AC
Manual override	impulse screw – 2 positions



Pneumatic impulse

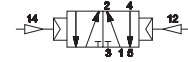
■ Single impulse



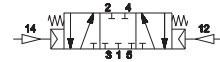
G-7230

G-7231

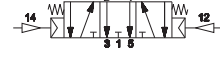
■ Double impulse



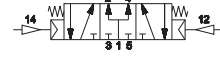
G-7233



G-7333



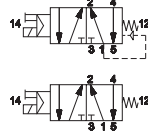
G-7433



G-7533

Electrical impulse

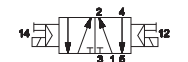
■ Single impulse



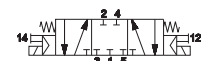
G-7290

G-7291

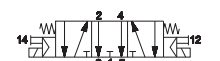
■ Double impulse



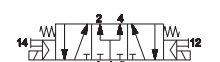
G-7299



G-7399



G-7499



G-7599

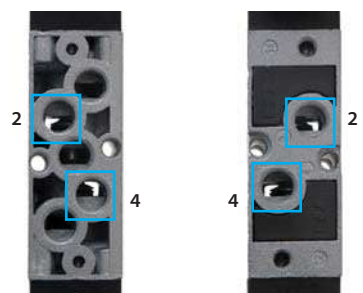
The valve is supplied with two plugs to be fixed with sealants on unused connections 2-4
Solenoid valves are supplied without coil/connector/locking nut

Multiple sub-base G1/8



	Places		Places
G-7900-02	2	G-7900-08	8
G-7900-03	3	G-7900-09	9
G-7900-04	4	G-7900-10	10
G-7900-05	5	G-7900-11	11
G-7900-06	6	G-7900-12	12
G-7900-07	7		

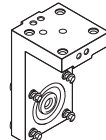
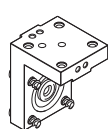
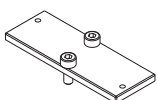
Threaded connections 2 - 4 on both sides of the valve



G-7885

AM-5151

AM-5152



Closing plate for sub-base place

Angle plate for "H" solenoid option

Angle plate for "P" solenoid option

INTEGRATED SUB-BASE

MANIFOLD valve with no sub-base

REDUCED DIMENSIONS

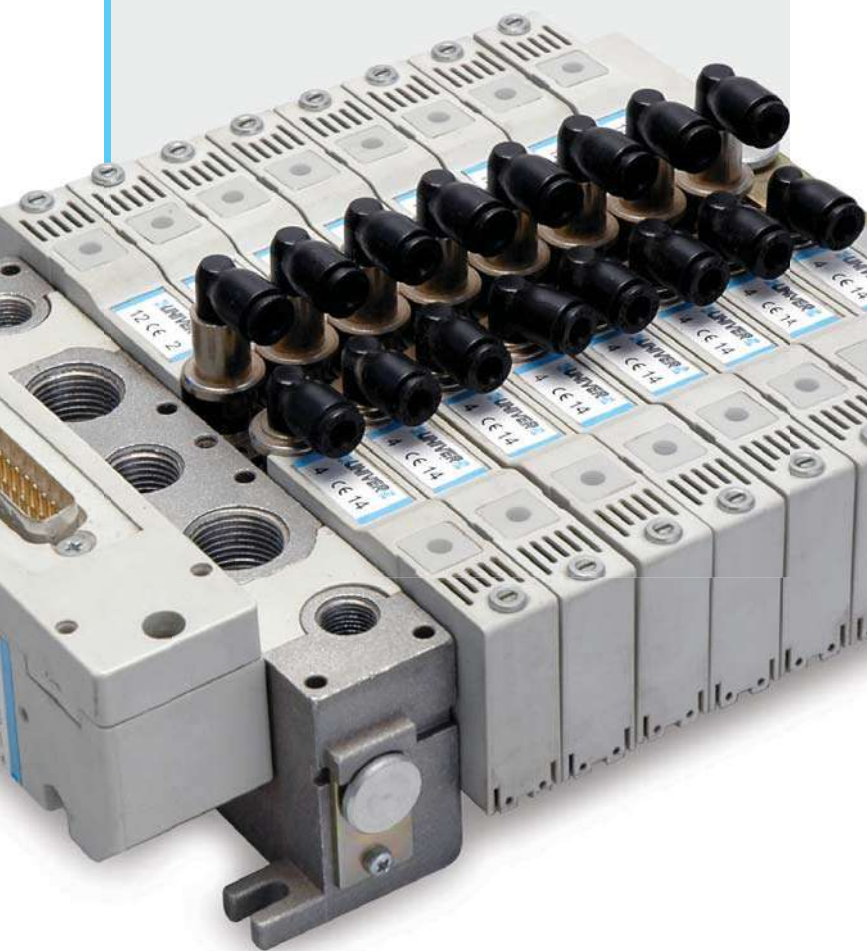
Space saving up to 30% in comparison with standard valve MANIFOLDS

HIGH FLOW RATE

830 NI/min spool system UNIVER Original

READY TO USE

Prewired configurations of 2 to 20 valves for a quick installation



PSC

Single electrical connection



PSP

Multipolar connection

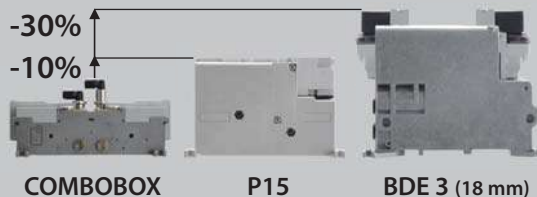


PSR

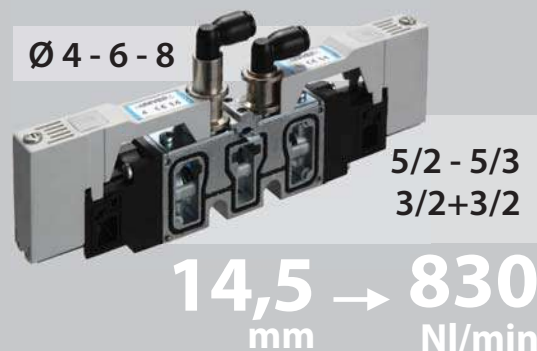
Pneumatic operation connection



REDUCED DIMENSIONS



MANIFOLD VALVE without sub-base



CHARACTERISTICS

Ambient temperature	-5 ÷ +50 °C (PSC-PSP), -15 ÷ +50 °C (PSR)
Fluid	10 µm filtered air, with or without lubrication
Commutation system	spool
Max pressure	9 bar (electrical control), 10 bar (pneumatic control)
Nominal bore (mm)	6
Nominal flow rate (NI/min)	depending on the type of fittings (see table)
Connections	tube Ø 4, 6, 8
Valve body	zamak
Seals	NBR
Spool	aluminium
Electropilot/Coil	B series/U04
Power consumption	1,35 W
Voltage	24 V DC (12 V DC upon request)
Protection degree	IP65
Manual override	recessed button - 1 position (PSC), impulse screw - 1-2 positions (PSP)



Nominal flow rate (NI/min)

	Ø4	Ø6	Ø8
Straight fitting	200	510	830
Elbow fitting	140	370	700

CODIFICATION KEY

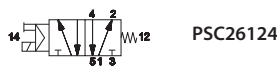
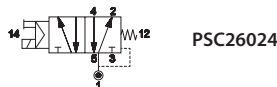
P	S	C	2	6	0	2	4
1	2	3	4	5			

1 Series	2 Type	3 Control 14	4 Return 12	5 Voltage and coil
PSC = Separate wires PSP = Plug-in PSR = Pneumatic	2 = 5/2 3 = 5/3 c.c. 4 = 5/3 o.c. 5 = 5/3 p.c. 6 = 3/2+3/2 NC-NC 7 = 3/2+3/2 NC-NO 8 = 3/2+3/2 NO-NO	2 = Pneumatic amplified 6 = Electrical amplified	0 = Pneumatic spring 1 = Mechanical spring 2 = Pneumatic amplified 3 = Pneumatic not amplified 6 = Electrical amplified 7 = Electrical not amplified	Only for PSC and PSP series, assembled coils with standard supplied led 24 = 24 V (standard) 12 = 12 V (upon request)

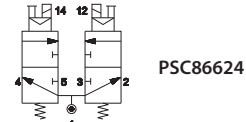
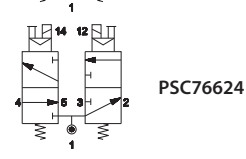
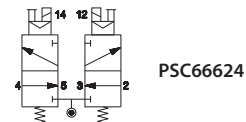
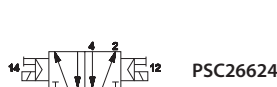
c.c. = closed centres o.c. = open centres p.c. = pressurized centres

PSC Electrical impulse - Electrical connection with separate wires

Single impulse

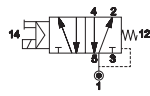


Double impulse

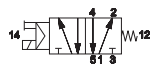


PSP Electrical impulse - Plug-in integrated electrical connection

Single impulse

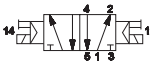


PSP26024

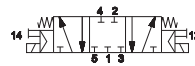


PSP26124

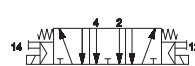
Double impulse



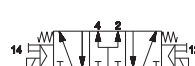
PSP26624



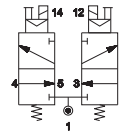
PSP36624



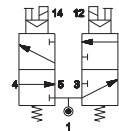
PSP46624



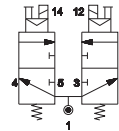
PSP56624



PSP66624



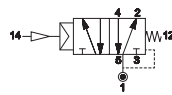
PSP76624



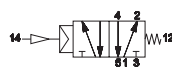
PSP86624

PSR Pneumatic impulse - Pneumatic operation

Single impulse

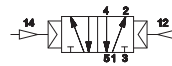


PSR220



PSR221

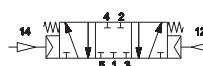
Double impulse



PSR222



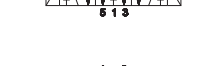
PSR223



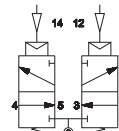
PSR322



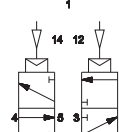
PSR422



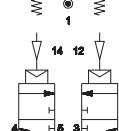
PSR522



PSR622



PSR722



PSR822

PSC Manifold with single electrical connection

- With 26 mm inlet plate and 14,5 mm end plate with DIN rail (EN50022)



- With 14,5 mm inlet and end plate



PSP Manifold with multipolar connection

- With 26 mm inlet plate and 14,5 mm end plate with multipolar connector



- With 26 mm inlet plate and 14,5 mm end plate with multipolar connector and intermediate plate



PSR Manifold with pneumatic operation

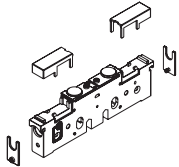
- With 26 mm inlet plate and 14,5 mm end plate



PS14100	PS14200	PS15000	PS15100	PS15200	PS15300*
26 mm inlet plate internal pilot supply	26 mm inlet plate external pilot supply	blank plate	14,5 mm inlet plate internal pilot supply	14,5 mm inlet plate external pilot supply	14,5 mm intermediate plate, closed air supply, open exhausts

PS15310*	PS15320*	PS15330*	PS15340	PS15350	PS15360
14,5 mm intermediate plate, open supply, closed exhausts	14,5 mm intermediate blank plate	14,5 mm intermediate open plate	intermediate supply plate with closed exhausts and internal pilot supply	intermediate supply plate with closed exhausts and external pilot supply	intermediate supply plate with open exhausts and internal pilot supply

PS15370



intermediate supply plate with open exhausts and external pilot supply

* = For intermediate plate with closed pilot supply ports add suffix 1 to part number. The intermediate plate takes one valve place. This needs to be considered for a proper purchase of modular tie rods.

Electropilots are supplied through end plates for internal as well as external supply. In case two different working pressures are applied to the end plates, it is possible to supply either all pilots with one of the two pressures (in general the higher one) or the pilots of each valve group with the working pressure of the same. This is made possible by means of a proper pressure separator. This same principle applies also in presence of more than two different pressures: in this case it is necessary to use intermediate supply plates suitably coupled with pressure separators.

PSK100145	PSK200145	PSK200290	PSK200725	PSK300145	PSK401
tie-rod with hexagonal ends	modular tie-rod L1 = 14,5 mm for each place	modular tie-rod L2 = 29 mm for 2 places	modular tie-rod L5 = 72,5 mm for 5 places	counter tie-rod	Fixing plate for DIN rail connection; with screws

GZR-100	GZR-101	GZR-102	GZR-V10004/6/8	GZR-V20004/6/8	GZR-V20L004/6/8
blanking plug	G1/8 Fitting seat reduction - gas thread for silencer mounting	G1/4 Fitting seat reduction - gas thread for silencer mounting	straight fitting GZR-V10004 tube: 4 mm GZR-V10006 tube: 6 mm GZR-V10008 tube: 8 mm	swivel low elbow fitting GZR-V20004 tube: 4 mm GZR-V20006 tube: 6 mm GZR-V20008 tube: 8 mm	swivel high elbow fitting GZR-V20L004 tube: 4 mm GZR-V20L006 tube: 6 mm GZR-V20L008 tube: 8 mm

TIM06M/10M/20M	TIM06B/10B	D-530C-100/200
male connector 25 poles, prewired for monostable valves (M) TIM06M (Max 6M) TIM10M (Max 10M) TIM20M (Max 20M)	male connector 25 poles, prewired for bistable valves (B) TIM06B (Max 6B) TIM10B (Max 10B)	miniature bipolar flying connector: stripped and tinned for protection D-530C-100 (wire length 1000 mm) D-530C-200 (wire length 2000 mm)

Electrical connections

sub-D female connector 25 poles without cable	sub-D flying female connector in compliance with CEI 20-22 O.R. II prewired for 24 coils (3-5-10 m length) M3x12 fixing screws

MIXED SYSTEM



For heavy applications
Fast commutation
Large number of cycles
High flow rate



AC 7

G1/8



1080
NI/min

AC 8

G1/4



1600
NI/min

AC 9

G1/2



4600
NI/min

Angle plate for "H"
solenoid option



Angle plate for "P"
solenoid option



Plate for external pilot
supply



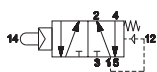
CHARACTERISTICS

Ambient temperature	-10 ÷ +45 °C		
Fluid	50 µm filtered air, with or without lubrication		
Commutation system	poppet mixed system		
Max pressure	10 bar		
Connections	G1/8	G1/4	G1/2
Nominal bore (mm)	6	8	15
Nominal flow rate (NI/min)	1080	1600	4600
Valve body	zamak	zamak	die-cast aluminium
Seals	NBR, polyurethane		
Spool	aluminium		
Electropilot	U1	U1	U2
Coil	DA	DA	DB
Power consumption	3,5 W (DC) - 5 VA (AC)	3,5 W (DC) - 5 VA (AC)	11 W (DC) - 10 VA (AC)
Connector	AM-5110	AM-5110	AM-5111
Voltage	12 V DC - 24 V DC - 24 V AC - 110 V AC - 230 V AC		
Manual override	impulse screw - 2 positions		



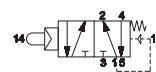
Indirect mechanical operation

■ Preset for pneumatic, mechanical and manual operators

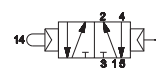


AC-7010 G1/8
AC-8010 G1/4
AC-9010 G1/2

■ Preset for panel operators Ø22



AC-7013 G1/8
AC-8013 G1/4
AC-9013 G1/2

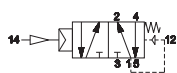


AC-7013P G1/8
AC-8013P G1/4
AC-9013P G1/2

AI-3550	AI-3551	AI-3560	AI-3562	AI-3563	AI-3570	AI-3571	AI-3572	AI-3511Q	AI-3514Q	AI-3515Q	AI-3520Q	AI-3522Q	AI-3524Q	AI-3525Q	AI-3526Q
AI-3511	AI-3514	AI-3515	AI-3520	AI-3522	AI-3524	AI-3525	AI-3526	AI-3512Q	AI-3516Q	AI-3517Q	AI-3521Q	AI-3523Q			
AI-3512	AI-3516	AI-3517	AI-3521	AI-3523				AI-3513Q	AI-3514QD	AI-3519Q					
AI-3513	AI-3514D	AI-3519	AI-3516D					AI-3516QD							

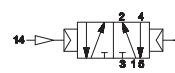
Pneumatic impulse

■ Single impulse



AC-7100 G1/8
AC-8100 G1/4
AC-9100 G1/2

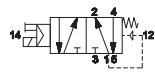
■ Double impulse



AC-7120 G1/8
AC-8120 G1/4
AC-9120 G1/2

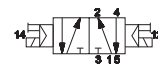
Electrical impulse

■ Single impulse



AC-7500 G1/8
 AC-8500 G1/4
 AC-9500 G1/2

■ Double impulse



AC-7520 G1/8
 AC-8520 G1/4
 AC-9520 G1/2

Solenoid valves are supplied without coil/connector/locking nut

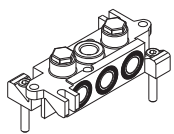
Modular sub-base

■ G1/8



AC-7900

AC-7905



Sub-base with connections
 G1/8

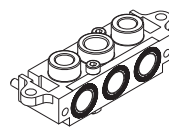


5/2 MIXED system inlet
 plate - G1/8

■ G1/4



AC-8900



Sub-base with threaded
 connections G1/4

Sub-bases are supplied with fixing screws

AM-5148

AM-5151

AM-5152

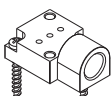
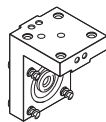
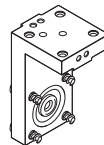


plate for external pilot supply
 G1/8 - G1/4



Angle plate for "H" solenoid
 option G1/8 - G1/4



Angle plate for "P" solenoid
 option G1/8 - G1/4

CHARACTERISTICS

Ambient temperature	-10 ÷ +45 °C
Fluid	50 µm filtered air, with or without lubrication
Commutation system	poppet
Max pressure	10 bar
Connections	G1/8
Nominal bore (mm)	5
Nominal flow rate (NI/min)	600 (NC), 550 (NO)
Valve body	zamak
Seals	NBR
Spool	nickel-plated brass



Roller lever - spring

One-way roller lever - spring

		CH-250			CH-260
		CH-252			CH-262
		CH-254			CH-264
		CH-256			CH-266

Ball push - spring

Button lever - spring

		CH-270			CH-280
		CH-272			CH-282
		CH-274			CH-284
		CH-276			CH-286

AF-AG

Poppet Valves G1/8 ÷ G1 1/2

WIDE RANGE

G1/8 ÷ G1 1/2
2/2 - 3/2 NC-NO

COMPRESSED AIR VERSION








VACUUM VERSION

Available also with external pilot
vacuum supply

HIGH FLOW RATE

Up to **35000 NI/min**
(G1 1/2)



		AF NI/min Compressed air	AG m ³ /h Vacuum
	G1/8 (Ø 5,5)	580	1,5
	G1/4 (Ø 8)	1100	4
	G3/8 (Ø 10)	1500	10
	G1/2 (Ø 15)	5400	20
	G3/4 (Ø 19)	6500	35
	G1 (Ø 25)	13500	90
	G1 1/2 (Ø 39)	35000	180

Poppet system

UNIVER Original since 1973



CHARACTERISTICS

Ambient temperature	Max +50 °C						
Fluid	50 µm filtered air, with or without lubrication						
Commutation system	poppet						
Max pressure	10 bar						
Connections	G1/8	G1/4	G3/8	G1/2	G3/4	G1	G1 1/2
Nominal bore (mm)	5,5	8	10	15	19	25	39
Nominal flow rate (l/min)	580	1100	1500	5400	6500	13500	35000
Valve body	zamak (G1/8 ÷ G1), aluminium (G1 1/2)						
Seals	polyurethane conical poppets and Vulkollan diaphragm						
Spool	aluminium (G1/8 ÷ G3/8), steel + plastic (G1/2 ÷ G1 1/2)						
	G1/8 ÷ G3/8			G1/4 ÷ G1 1/2			
Electropilot	U1			U2			
Coil	DA			DB			
Power consumption	3,5 W (DC) - 5 VA (AC)			11 W (DC) - 10 VA (AC)			
Connector	AM-5110			AM-5111			
Voltage	12 V DC - 24 V DC - 24 V AC - 110 V AC - 230 V AC						
Manual override	impulse screw - 2 positions						



Solenoid valves G1/8 ÷ G3/8

		3/2 NC AF-2500 G1/8 U1			3/2 NC AF-2510 G1/4 U1 AF-2517 G1/4 U2 AF-2520 G3/8 U1 AF-2524 G3/8 U2
		3/2 NO AF-2501 G1/8 U1			3/2 NO AF-2511 G1/4 U1 AF-2518 G1/4 U2 AF-2521 G3/8 U1 AF-2525 G3/8 U2

Solenoid valves G1/2 ÷ G1 1/2

		3/2 NC AF-2530 G1/2 U2 AF-2540 G3/4 U2 AF-2545 G1 U2			3/2 NC AF-2565 G1 1/2 U2
		3/2 NO AF-2531 G1/2 U2 AF-2541 G3/4 U2 AF-2546 G1 U2			3/2 NO AF-2561 G1 1/2 U2

Pneumatic valves with external operation G1/8 ÷ G3/8

		3/2 NC AF-2600 G1/8			3/2 NC AF-2601 G1/4 AF-2606 G3/8
		3/2 NO AF-2700 G1/8			3/2 NO AF-2701 G1/4 AF-2706 G3/8

Solenoid valves are supplied without coil/connector/locking nut

Pneumatic valves with external operation G1/2 ÷ G1 1/2

		<p>3/2 NC-NO AF-2603 G1/2 AF-2610 G3/4 AF-2615 G1</p>			<p>3/2 NC-NO AF-2620 G1 1/2</p>
--	--	--	--	--	--

2/2 Solenoid valve for blowing G1

2/2 Pneumatic valve for blowing with ext. operation G1

		<p>2/2 NC AF-2550 G1 2/2 NC AF-2551 G1 2/2 NC AF-2552 G1</p>			<p>2/2 NC AF-2617 G1</p>
--	--	---	--	--	---

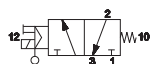
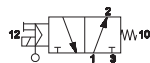
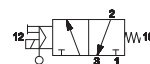
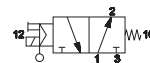
Solenoid valves are supplied without coil/connector/locking nut

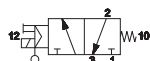
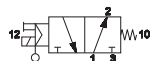
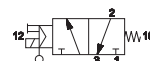
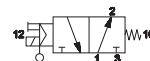
CHARACTERISTICS

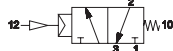
Ambient temperature	Max +50 °C						
Fluid	50 µm filtered air, with or without lubrication - vacuum						
Commutation system	poppet						
Max vacuum	759,5 mm Hg						
Connections	G1/8	G1/4	G3/8	G1/2	G3/4	G1	G1 1/2
Nominal bore (mm)	5,5	8	10	15	19	25	39
Valve body	zamak (G1/8 ÷ G1), aluminium (G1 1/2)						
Seals	polyurethane conical poppets and Vulkollan diaphragm ^(a) ; silicon poppets ^(b)						
Spool	aluminium (G1/8 ÷ G3/8), steel + plastic (G1/2 ÷ G1 1/2)						
	G1/8 ÷ G3/8			G1/4 ÷ G1 1/2			
Electropilot	U1			U2			
Coil	DA			DB			
Power consumption	3,5 W (DC) - 5 VA (AC)			11 W (DC) - 10 VA (AC)			
Connector	AM-5110			AM-5111			
Voltage	12 V DC - 24 V DC - 24 V AC - 110 V AC - 230 V AC						
Manual override	impulse screw - 2 positions						

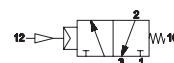
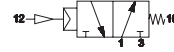
(a) = valve for vacuum with external air operation

(b) = valve for direct vacuum with external vacuum operation


3/3 Solenoid valve for vacuum with external pilot air supply G1/8 ÷ G3/8

 3/2 NC
 AG-3001 G1/8

 3/2 NO
 AG-3002 G1/8

 3/2 NC
 AG-3009 G1/4
 AG-3011 G3/8

 3/2 NO
 AG-3010 G1/4
 AG-3012 G3/8

3/2 Solenoid valve for vacuum with external pilot air supply G1/2 ÷ G1 1/2

 3/2 NC
 AG-3020 G1/2
 AG-3040 G3/4
 AG-3050 G1

 3/2 NO
 AG-3021 G1/2
 AG-3041 G3/4
 AG-3051 G1

 3/2 NC
 AG-3062 G1 1/2

 3/2 NO
 AG-3063 G1 1/2

3/2 Pneumatic valve for vacuum with external air operation G1/8 ÷ G3/8

 3/2 NC
 AG-3071 G1/8

 3/2 NO
 AG-3072 G1/8

 3/2 NC
 AG-3073 G1/4
 AG-3075 G3/8

 3/2 NO
 AG-3074 G1/4
 AG-3076 G3/8

2/2 NC-NO version available upon request

Solenoid valves are supplied without coil/connector/locking nut

3/2 Pneumatic valve for vacuum with external air operation G1/2 ÷ G1 1/2

		3/2 NC AG-3081 G1/2 AG-3091 G3/4 AG-3100 G1			3/2 NC AG-3110 G1 1/2
		3/2 NO AG-3082 G1/2 AG-3092 G3/4 AG-3101 G1			3/2 NO AG-3111 G1 1/2

3/2 Solenoid valve for direct vacuum with pilot vacuum supply G1/4 ÷ G1 1/2

		3/2 NC AG-3210 G1/4 AG-3214 G3/8			3/2 NC AG-3222 G1/2 AG-3232 G3/4 AG-3242 G1
		3/2 NO AG-3211 G1/4 AG-3215 G3/8			3/2 NO AG-3223 G1/2 AG-3233 G3/4 AG-3243 G1
		3/2 NC AG-3256 G1 1/2			3/2 NO AG-3257 G1 1/2
		3/2 NO AG-3257 G1 1/2			

2/2 - 3/2 Solenoid valve for vacuum with direct operation G1/4 - G1/2

		3/2 NC AG-3310 G1/4 AG-3311 G1/4 AG-3312 G1/4 AG-3313 G1/4			3/2 NC AG-3330 G1/2 AG-3331 G1/2 AG-3332 G1/2
		2/2 NC AG-3300 G1/4 AG-3301 G1/4 AG-3302 G1/4 AG-3303 G1/4			2/2 NC AG-3320 G1/2 AG-3321 G1/2 AG-3322 G1/2

■ U2 - 17 VA coil

	DB-0607 24V AC - 50/60 Hz
	DB-0608 110V AC - 50/60 Hz
	DB-0610 220V AC - 50/60 Hz

Solenoid valves are supplied without coil/connector/locking nut

CHARACTERISTICS

Ambient temperature	-10 ÷ +90 °C	
Fluid	50 µm filtered air, with or without lubrication	
Commutation system	poppet	
Max pressure	10 bar	
Connections	interface for sub-base	
	standard	sensible
Nominal bore (mm)	2,3	1,5
Nominal flow rate (l/min)	110	55
Force (N)	5	4
Valve body	zamak	
Seals	NBR	
Spool	nickel-plated brass	



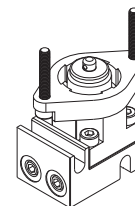
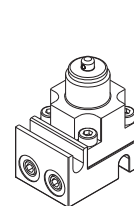
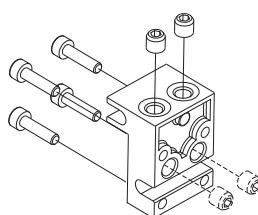
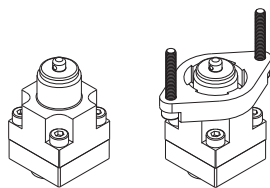
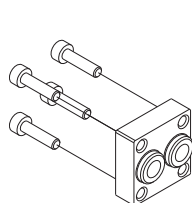
Mechanical push button - spring

Mechanical push button for panel operation - spring

		AI-3500 standard													
		AI-3500S sensible													
		AI-3501 standard													
		AI-3501S sensible													
		AI-3502 standard													
		AI-3503 2/2 NO Available upon request													
		AI-3500Q standard													
		AI-3500SQ sensible													
		AI-3501Q standard													
		AI-3501SQ sensible													
		AI-3502Q standard													
		AI-3503Q 2/2 NO Available upon request													
AI-3550	AI-3551	AI-3560	AI-3562	AI-3563	AI-3570	AI-3571	AI-3572	AI-3511Q	AI-3514Q	AI-3515Q	AI-3520Q	AI-3524Q	AI-3522Q	AI-3525Q	AI-3526Q
								AI-3512Q	AI-3516Q	AI-3517Q	AI-3521Q			AI-3523Q	
								AI-3513Q	AI-3514QD	AI-3519Q					
								AI-3516QD							
AI-3511	AI-3514	AI-3515	AI-3520	AI-3522	AI-3524	AI-3525	AI-3526								
AI-3512	AI-3516	AI-3517	AI-3521	AI-3523											
AI-3513	AI-3514D	AI-3519													
	AI-3516D														

AI-3610

AI-3612



Sub-base with bottom connections M5

Sub-base with side or bottom connections M5

Sub-bases are supplied with M3x12 fixing screws (4 pcs) and M5x5 grub screws (2pcs) to close the unused ways.

Grub screws must be fixed with sealing loctite (243 type), being sure that loctite does not obstruct the ports or sink inside the valve.



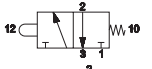
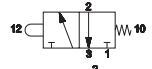
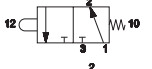
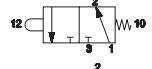
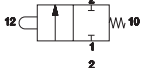
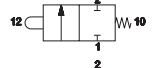
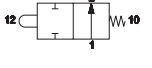
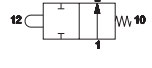
Grub screws must be screwed until reaching the base surface. Avoid screwing them completely.

CHARACTERISTICS

Ambient temperature	-10 ÷ +90 °C
Fluid	50 µm filtered air, with or without lubrication
Commutation system	poppet
Max pressure	10 bar
Connections	M5, tube Ø4
Nominal bore (mm)	2,5
Nominal flow rate (NI/min)	70
Valve body	zamak
Seals	NBR
Spool	nickel-plated brass





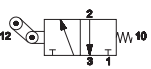
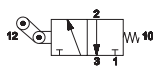
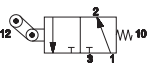
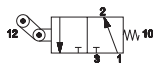
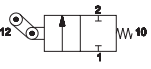
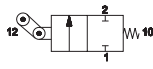
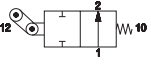
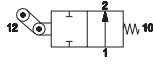
Ball push - spring

<p>■ Tube Ø4</p> 	<p>■ M5</p> 
<p>AI-9000</p> 	<p>AI-9000M</p> 
<p>AI-9010</p> 	<p>AI-9010M</p> 
<p>AI-9020</p> 	<p>AI-9020M</p> 
<p>AI-9030</p> 	<p>AI-9030M</p> 

Roller lever - spring

<p>■ Tube Ø4</p> 	<p>■ M5</p> 
<p>AI-9100</p> 	<p>AI-9100M</p> 
<p>AI-9110</p> 	<p>AI-9110M</p> 
<p>AI-9120</p> 	<p>AI-9120M</p> 
<p>AI-9130</p> 	<p>AI-9130M</p> 

One-way roller lever - spring

<p>■ Tube Ø4</p> 	<p>■ M5</p> 
<p>AI-9200</p> 	<p>AI-9200M</p> 
<p>AI-9210</p> 	<p>AI-9210M</p> 
<p>AI-9220</p> 	<p>AI-9220M</p> 
<p>AI-9230</p> 	<p>AI-9230M</p> 


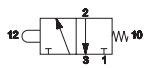

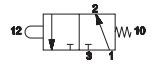
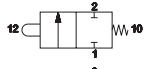
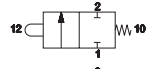
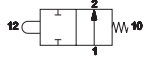
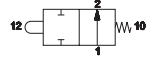
Bulkhead mechanical push button - spring









■ Tube Ø4		■ M5	
		AI-9300	
		AI-9310	
		AI-9320	
		AI-9330	

Button lever - spring

■ Tube Ø4		■ M5	
		AI-9350	
		AI-9360	
		AI-9370	
		AI-9380	

Mechanical push button for panel operation - spring

■ Tube Ø4		■ M5	
		AI-9400	
		AI-9410	
		AI-9420	
		AI-9430	

							
AI-3511Q ■	AI-3514Q ■	AI-3515Q ■	AI-3520Q ■	AI-3524Q ■	AI-3522Q ■	AI-3525Q ■	AI-3526Q ■
AI-3512Q ■	AI-3516Q ■	AI-3517Q ■	AI-3521Q ■		AI-3523Q ■		
AI-3513Q ■	AI-3514QD ■	AI-3519Q ■					
	AI-3516QD ■						

CHARACTERISTICS

Ambient temperature	-10 ÷ +90 °C
Fluid	50 µm filtered air, with or without lubrication
Commutation system	poppet
Max pressure	10 bar
Connections	M5, tube Ø4
Nominal bore (mm)	2,5
Nominal flow rate (NI/min)	70
Valve body	zamak
Seals	NBR
Spool	nickel-plated brass


Mechanical push button for panel mounting

■ Tube Ø4		■ M5	
	 AI-9500B 3/2 NC AI-9510B 3/2 NO AI-9520B 2/2 NC		 AI-9500BM 3/2 NC AI-9510BM 3/2 NO AI-9520BM 2/2 NC
	 AI-9550B 5/2 AI-9560B 5/3 o.c. AI-9570B 5/3 p.c.		 AI-9550BM 5/2 AI-9560BM 5/3 o.c. AI-9570BM 5/3 p.c.

o.c. = open centres p.c. = pressurized centres

Recessed button AI-35B10N ■ AI-35B10R ■ AI-35B10V ■	Protruding button AI-35B11N ■ AI-35B11R ■ AI-35B11V ■	Two-position head button AI-35B13N ■ AI-35B13R ■	Short lever selector AI-35B20 2 steady positions AI-35B21 3 unsteady positions AI-35B22 3 steady positions	Long lever selector AI-35B25 2 steady positions AI-35B26 3 unsteady positions AI-35B27 3 steady positions	Key selector AI-35B30 2 steady positions AI-35B31 3 unsteady positions AI-35B32 3 steady positions

CHARACTERISTICS

Ambient temperature	-10 ÷ +70 °C	
Fluid	filtered air 50 µm, with or without lubrication	
Commutation system	poppet	
Max pressure	10 bar	
Connections	G1/8	G1/4
Nominal bore (mm)	2,3	8
Nominal flow rate (NI/min)	98	800
PNEUMATIC FOOT VALVE:		
Valve body	zamak	
Foot valve lever	aluminium	
Pedal body and protection	plastic material with reinforcing steel plate	
Seals	oil and wear resistant compound	
Spool	aluminium	
SOLENOID FOOT VALVE		
Valve body, foot valve lever, protection	dielectric plastic material	


Pneumatic foot valve G1/4 with protection

■ Spring return

AM-5000

AM-5001

AM-5002

■ Bistable

AM-5003

AM-5004

AM-5005

■ With safety control

AM-5015

AM-5011

AM-5012

■ External operation - Spring return

AM-5021

■ External operation - bistable

AM-5031

■ External operation with safety control

AM-5041

Pneumatic foot valve G1/4 without protection

■ Spring return

AM-5000A

AM-5001A

■ Bistable

AM-5003A

AM-5004A

Pneumatic foot valve G1/8 with protection

■ Spring return

AM-5043

AM-5043B

AM-5043C

AM-5043D

Solenoid foot valve

AM-5050
No electrical microswitch

AM-5051
Electrical microswitch

AM-5052
Double electrical microswitch

Version without protection available upon request

HIGH FLOW RATE

310 NI/min (UNIVER traditional spool technology)

COMPACT SIZE: 10 mm

Highest reduction of overall dimensions

EASY INSTALLATION

All pneumatic connections on the same side

COMPLETE SOLUTION

Threaded body and body for sub-base mounting
5/2 - 5/3 - 3/2+3/2

1 w
Standard

0,3 w
Low consumption



P10F



P10B



P10F

Threaded ports (M5)

Electrical connection with external connector



Integrated electrical connection



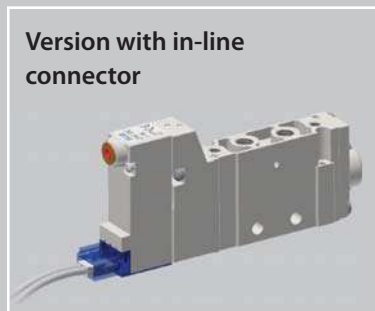
P10B

For sub-base (M5-M7-Tube 4)

Integrated electrical connection



Version with in-line connector



TC Series

Connection to modular serial communication system



CHARACTERISTICS

Ambient temperature	-5 ÷ +50 °C	
Fluid	10 µm filtered air, with or without lubrication	
Commutation system	spool	
Max pressure	9 bar (electrical control) * 10 bar (pneumatic control)	
Connections	M5 (P10F) - M5, M7, tube Ø 4 (P10B)	
Nominal flow rate (NI/min)	310 (5/2) 230 (5/3) 250 (3/2+3/2)	
Valve body	zamac	
Seals	NBR	
Electropilot	B10 (0,3W) - B11 (1 W)	
Spool	aluminium	
Voltage	24 V DC (± 10%)	
Power consumption	B10 = 0,3 W, Speed-up 1 W (25 ms) B11 = 1 W	
Protection degree	IP65	
Manual override	recessed button - 1 position	



* = At pressure higher than 7bar with B10 pilot (0.3W) it is recommended to use solenoid valves with external pilot supply

CODIFICATION KEY

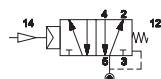
P	1	0	F	2	4	4	2	4	
	1	2	3	4	5	6			

1 Series	2 Type	3 Control 14	4 Return 12
P10F = Threaded body P10B = Body for sub-base	2 = 5/2 3 = 5/3 c.c. 4 = 5/3 o.c. 5 = 5/3 p.c.	6 = 3/2+3/2 NC-NC 7 = 3/2+3/2 NC-NO 8 = 3/2+3/2 NO-NO	3 = Pneumatic amplified 4 = Electrical amplified 90° (0,3W) 6 = Electrical amplified 90° (1W)
5 Voltage	6 Option		
24 = 24 V DC	D = External pilot supply on valve body (P10 = M3)		

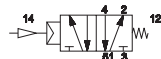
c.c. = closed centres o.c. = open centres p.c. = pressurized centres

Pneumatic impulse - Threaded connections M5

■ Single impulse



P10F230

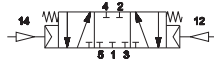


P10F231

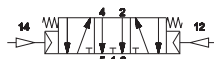
■ Double impulse



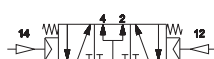
P10F233



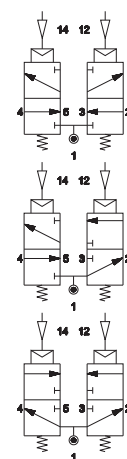
P10F333



P10F433



P10F533



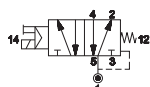
P10F633

P10F733

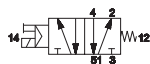
P10F833

Electrical impulse - Threaded connections M5

Single impulse



P10F24024 0,3 W
P10F26024 1 W



P10F24124 0,3 W
P10F26124 1 W

B10



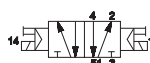
Low power consumption 0,3 W

NEW - B11

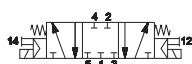


Standard 1 W

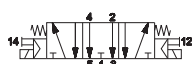
Double impulse



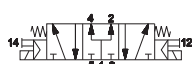
P10F24424 0,3 W
P10F26624 1 W



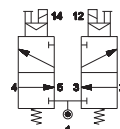
P10F34424 0,3 W
P10F36624 1 W



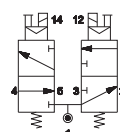
P10F44424 0,3 W
P10F46624 1 W



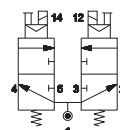
P10F54424 0,3 W
P10F56624 1 W



P10F64424 0,3 W
P10F66624 1 W



P10F74424 0,3 W
P10F76624 1 W

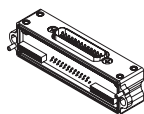


P10F84424 0,3 W
P10F86624 1 W

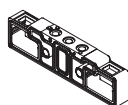
Integrated electrical connection



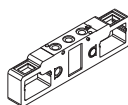
TIM1024 P10SF100 P10SF110 P10SF200 P10SF210 P10SF500



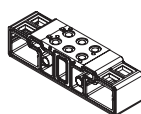
male connection module
25 poles, type sub-D



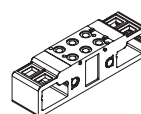
sub-base 1 place



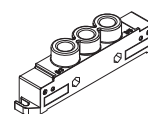
sub-base 1 place
1-3-5 closed



sub-base 2 places

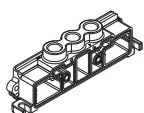


sub-base 2 places
1-3-5 closed

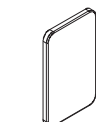


left supply plate G1/8
for TIM module

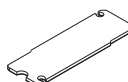
P10SF505 P10SF550 P10SF560 P10SF570 P10SS14**M P10SS12**M



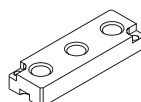
right supply plate G1/8



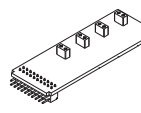
pressure separator



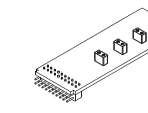
closing plate for unused
valve place



intermediate supply plate
for threaded version



bus connection card,
side 14
** = 04, 06, 08, 10, 12 places



bus connection card,
side 12
** = 04, 06, 08, 10, 12 places

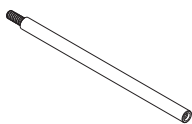
P10STR01 P10STR02 P10STR05



modular tie-rods
1 valve place



modular tie-rods
2 valve places



modular tie-rods
5 valve places

AZ4-SN003A

No. 100 nuts M3 for tie-rods

AZ4-VN0310

No. 100 screws M3x10 for tie-rods

Electrical connection with external connector

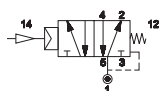
3



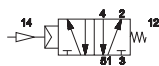
P10SF300	P10SF310	P10SF400	P10SF410	P10SF515	P10SF550
sub-base 1 place	sub-base 1 place 1-3-5 closed	sub-base 2 places	sub-base 2 places 1-3-5 closed	right/left supply place G1/8	pressure separator
P10SF560	P10SF570	P10STR01	P10STR02	P10STR05	
closing plate for unused valve place	intermediate supply plate for threaded version	modular tie-rods 1 valve place	modular tie-rods 2 valve places	modular tie-rods 5 valve places	
					AZ4-SN003A No. 100 nuts M3 for tie-rods
					AZ4-VN0310 No. 100 screws M3x10 for tie-rods

Pneumatic impulse - Body for sub-base mounting

Single impulse



P10B230

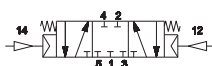


P10B231

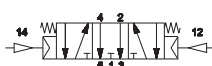
Double impulse



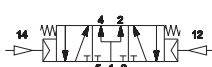
P10B233



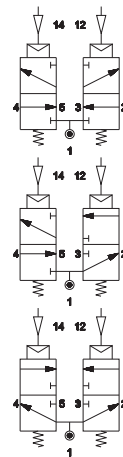
P10B333



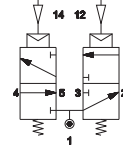
P10B433



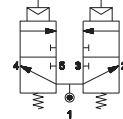
P10B533



P10B633



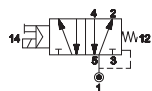
P10B733



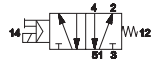
P10B833

Electrical impulse - Body for sub-base mounting

Single impulse



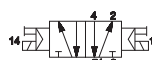
P10B24024 0,3 W
P10B26024 1 W



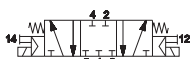
P10B24124 0,3 W
P10B26124 1 W

<p>B10</p> <p>Low power consumption 0,3 W</p>	<p>NEW - B11</p> <p>Standard 1 W</p>
---	--------------------------------------

Double impulse



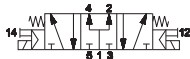
P10B24424 0,3 W
P10B26624 1 W



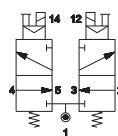
P10B34424 0,3 W
P10B36624 1 W



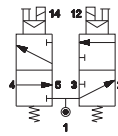
P10B44424 0,3 W
P10B46624 1 W



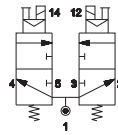
P10B54424 0,3 W
P10B56624 1 W



P10B64424 0,3 W
P10B66624 1 W



P10B74424 0,3 W
P10B76624 1 W



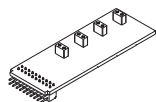
P10B84424 0,3 W
P10B86624 1 W

Integrated electrical connection

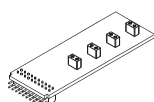


TIM1024	P10SB100/107	P10SB110/117	P10SB200/207	P10SB210/217	P10SB304	P10SB314
male connection module 25 poles, type sub-D	sub-base 1 place side outlets M5, M7	sub-base 1 place side outlets M5, M7 1-3-5 closed	sub-base 2 places side outlets M5, M7	sub-base 2 places side outlets M5, M7 1-3-5 closed	sub-base 1 place side outlets with push-in connections tube 4	sub-base 1 place side outlets with push-in connections tube 4 1-3-5 closed
P10SB404	P10SB414	P10SB500	P10SB505	P10SB550	P10SB560	P10SB570
sub-base 2 places side outlets with push-in connections tube 4	sub-base 2 places side outlets with push-in connections tube 4 1-3-5 closed	supply plate G1/8 for TIM module	right supply plate G1/8	pressure separator	closing plate for unused valve place	intermediate supply plate for sub-base version

P10SS14M P10SS12**M P10STR01 P10STR02 P10STR05**



bus connection card, side 14
** = 04, 06, 08, 10, 12 places



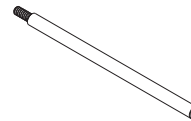
bus connection card, side 12
** = 04, 06, 08, 10, 12 places



modular tie-rods
1 valve place



modular tie-rods
2 valve places



modular tie-rods
5 valve places

AZ4-SN003A

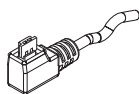
No. 100 nuts M3 for tie-rods

AZ4-VN0310

No. 100 screws M3x10 for tie-rods

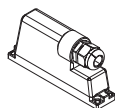
Electrical connections

**D-535U40300
D-535U40500**



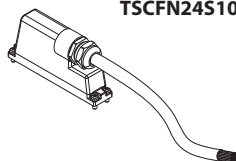
single connector cable 3-5 m

TSCFN24S000



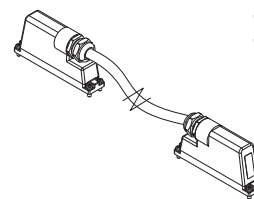
female connector
25 poles, type sub-D, no cable
M3x8 fixing screws

**TSCFN24S0300
TSCFN24S0500
TSCFN24S1000**



female connector
25 poles, type sub-D, prewired for 24
coils (3-5-10 m length)
M3x8 fixing screws

**TSCFN16D0300
TSCFN16D0500
TSCFN16D1000**



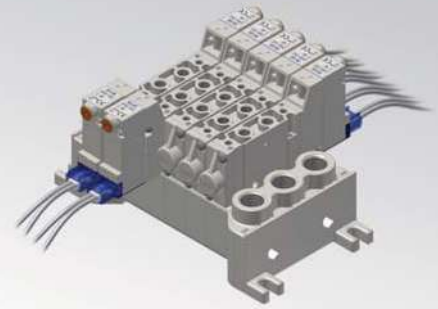
sub-D male/female flying connector (upon request)
prewired for 16 coils with cable Ø 8 mm (3-5-10 m length)
suitable for dynamic laying - M3x8 fixing screws

■ TC series Serial Communication System



CHARACTERISTICS

Ambient temperature	-5 ÷ +50 °C	
Fluid	10 µm filtered air, with or without lubrication	
Commutation system	spool	
Max pressure	9 bar (electrical control) * 10 bar (pneumatic control)	
Connections	M5 (P10F) - M5, M7, tube Ø 4 (P10B)	
Nominal flow rate (NI/min)	310 (5/2) 230 (5/3) 250 (3/2+3/2)	
Valve body	zamak	
Seals	NBR	
Electropilot	B10 (0,3W) - B11 (1 W)	
Spool	aluminium	
Voltage	24 V DC (± 10%)	
Power consumption	B10 = 0,3 W, speed -up 1 W (25 ms) B11 = 1 W	
Protection degree	IP65	
Manual override	recessed button - 1 position	



* = At pressure higher than 7bar with B10 pilot (0.3W) it is recommended to use solenoid valves with external pilot supply

CODIFICATION KEY

P	1	0	F	2	8	0	2	4	
	1	2	3	4	5	6			

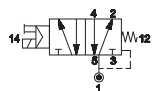
1 Series	2 Type	3 Control 14	4 Return 12
P10F = Threaded body P10B = Body for sub-base	2 = 5/2 3 = 5/3 c.c. 4 = 5/3 o.c. 5 = 5/3 p.c.	6 = 3/2+3/2 NC-NC 7 = 3/2+3/2 NC-NO 8 = 3/2+3/2 NO-NO	8 = Electrical amplified in-line (0,3W) 9 = Electrical amplified in-line (1W)
			0 = Pneumomechanical spring 1 = Mechanical spring 8 = Electrical amplified in-line (0,3W) 9 = Electrical amplified in-line (1W)

5 Voltage	6 Option
24 = 24 V DC	D = External pilot supply on valve body (P10 = M3)

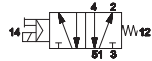
c.c. = closed centres o.c. = open centres p.c. = pressurized centres

Electrical impulse - Threaded connections M5

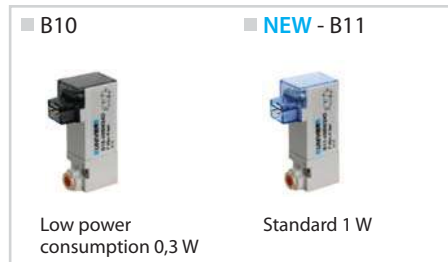
■ Single impulse



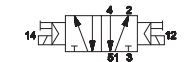
P10F28024 0,3 W
 P10F29024 1 W



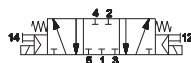
P10F28124 0,3 W
 P10F29124 1 W



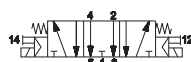
■ Double impulse



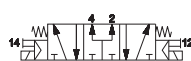
P10F28824 0,3 W
 P10F29924 1 W



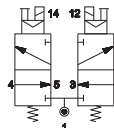
P10F38824 0,3 W
 P10F39924 1 W



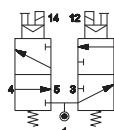
P10F48824 0,3 W
 P10F49924 1 W



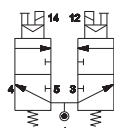
P10F58824 0,3 W
 P10F59924 1 W



P10F68824 0,3 W
 P10F69924 1 W



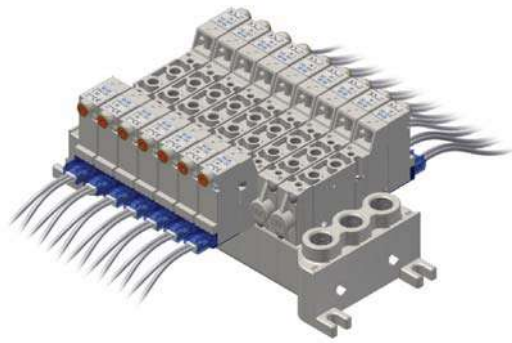
P10F78824 0,3 W
 P10F79924 1 W



P10F88824 0,3 W
 P10F89924 1 W

Electrical connection with external connector

3



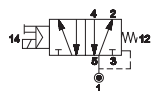
P10SF300	P10SF310	P10SF400	P10SF410	P10SF515	P10SF550
sub-base 1 place	sub-base 1 place 1-3-5 closed	sub-base 2 places	sub-base 2 places 1-3-5 closed	right/left supply plate G1/8	pressure separator
P10SF560	P10SF570	P10STR01	P10STR02	P10STR05	
closing plate for unused valve place	intermediate supply plate for threaded version	modular tie-rods 1 valve place	modular tie-rods 2 valve places	modular tie-rods 5 valve places	

AZ4-SN003A
No. 100 nuts M3
for tie-rods

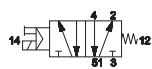
AZ4-VN0310
No. 100 screws M3x10
for tie-rods

Electrical impulse - Body for sub-base mounting

Single impulse



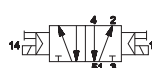
P10B28024 0,3 W
P10B29024 1 W



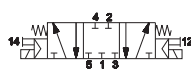
P10B28124 0,3 W
P10B29124 1 W

■ B10	■ NEW - B11
Low power consumption 0,3 W	Standard 1 W

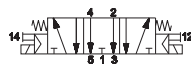
Double impulse



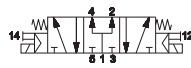
P10B28824 0,3 W
P10B29924 1 W



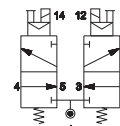
P10B38824 0,3 W
P10B39924 1 W



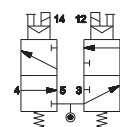
P10B48824 0,3 W
P10B49924 1 W



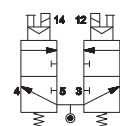
P10B58824 0,3 W
P10B59924 1 W



P10B68824 0,3 W
P10B69924 1 W

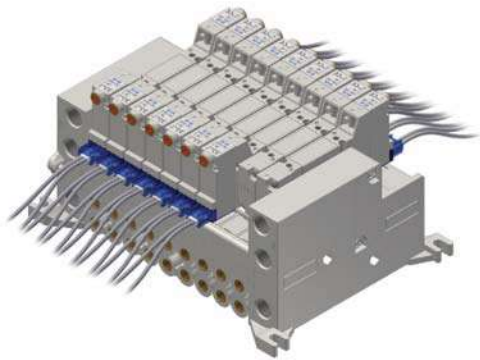


P10B78824 0,3 W
P10B79924 1 W



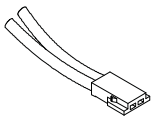
P10B88824 0,3 W
P10B89924 1 W

Electrical connection with external connector



P10SB100/107	P10SB110/117	P10SB200/207	P10SB210/217	P10SB304	P10SB314
sub-base 1 place side outlets M5, M7	sub-base 1 place side outlets M5, M7 1-3-5 closed	sub-base 2 places side outlets M5, M7	sub-base 2 places side outlets M5, M7 1-3-5 closed	sub-base 1 place side outlets with push-in connections tube 4	sub-base 1 place side outlets with push-in connections tube 4 1-3-5 closed
P10SB404	P10SB414	P10SB502	P10SB505	P10SB550	P10SB560
sub-base 2 places side outlets with push-in connections tube 4	sub-base 2 places side outlets with push-in connections tube 4 1-3-5 closed	supply plate G1/8	right supply plate G1/8	pressure separator	closing plate for unused valve place
P10SB570	P10STR01	P10STR02	P10STR05		
intermediate supply plate for sub-base	modular tie-rods 1 valve place	modular tie-rods 2 valve places	modular tie-rods 5 valve places	<p>AZ4-SN003A No. 100 nuts M3 for tie-rods</p> <p>AZ4-VN0310 No. 100 screws M3x10 for tie-rods</p>	

D-530-30/50/200



Miniature connector with loose cables
D-530-30 = wire length 300 mm
D-530-50 = wire length 500 mm
D-530-200 = wire length 2000 mm

HIGH FLOW RATE

800 NI/min (UNIVER traditional spool technology)

COMPACT SIZE: 15 mm

Highest reduction of overall dimensions

EASY INSTALLATION

All pneumatic connections on the same side

COMPLETE SOLUTION

Threaded body and body for sub-base mounting

5/2 - 5/3 - 3/2+3/2

1 w

Standard

0,3 w

Low consumption



P15F



P15B



P15F

Threaded ports (G1/8)

Electrical connection with external connector



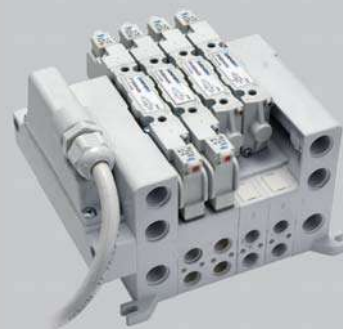
Integrated electrical connection



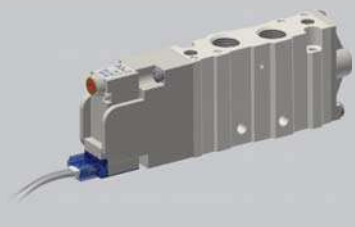
P15B

For sub-base (G1/8 - Tube 4-6-8)

Integrated electrical connection



Version with in-line connector



TC Series

Connection to modular serial communication system



CHARACTERISTICS

Ambient temperature	-5 ÷ 50 °C	
Fluid	10 µm filtered air, with or without lubrication	
Commutation system	spool	
Max pressure	9 bar (electrical control) * 10 bar (pneumatic control)	
Connections	G1/8 (P15F) - G1/8 - tube Ø 4-6-8 (P15B)	
Nominal flow rate (NI/min)	800 (5/2) 720 (5/3) 720 (3/2+3/2)	
Valve body	zamak	
Seals	NBR	
Spool	aluminium	
Electropilot	B10 (0,3W) - B11 (1 W)	
Voltage	24 V DC (± 10%)	
Power consumption	B10 = 0,3 W, speed -up 1 W (25 ms) B11 = 1 W	
Protection degree	IP65	
Manual override	recessed button - 1 position	



* = At pressure higher than 7bar with B10 pilot (0.3W) it is recommended to use solenoid valves with external pilot supply

CODIFICATION KEY

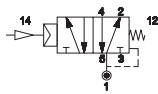
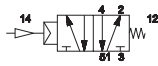
P	1	5	F	2	4	4	2	4	
	1	2	3	4	5	6			

1 Series	2 Type	3 Control 14	4 Return 12
P15F = Threaded body P15B = Body for sub-base P15D = Threaded body 15 mm connector	2 = 5/2 3 = 5/3 c.c. 4 = 5/3 o.c. 5 = 5/3 p.c.	6 = 3/2+3/2 NC-NC 7 = 3/2+3/2 NC-NO 8 = 3/2+3/2 NO-NO	3 = Pneumatic amplified 4 = Electrical amplified 90° (0,3W) 6 = Electrical amplified 90° (1W)
			0 = Pneumomechanical spring 1 = Mechanical spring 3 = Pneumatic amplified 4 = Electrical amplified 90° (0,3W) 6 = Electrical amplified 90° (1W)
5 Voltage	6 Option		
24 = 24 V DC	D = External pilot supply on valve body (P15 = M5)		

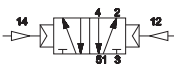
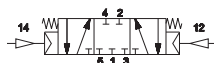
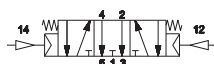
c.c. = closed centres o.c. = open centres p.c. = pressurized centres

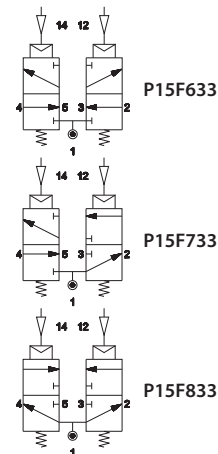
Pneumatic impulse - Threaded connections G1/8

■ Single impulse


P15F230

P15F231

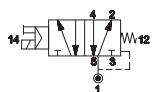
■ Double impulse


P15F233

P15F333

P15F433

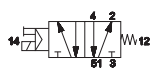
P15F533

P15F633
P15F733
P15F833

Electrical impulse - Threaded connections G1/8

Single impulse



P15F24024 0,3 W
P15F26024 1 W



P15F24124 0,3 W
P15F26124 1 W

B10



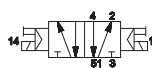
Low power consumption 0,3 W

NEW - B11

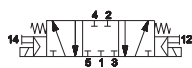


Standard 1 W

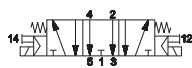
Double impulse



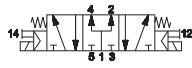
P15F24424 0,3 W
P15F26624 1 W



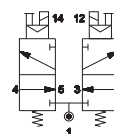
P15F34424 0,3 W
P15F36624 1 W



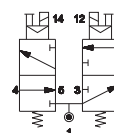
P15F44424 0,3 W
P15F46624 1 W



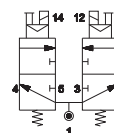
P15F54424 0,3 W
P15F56624 1 W



P15F64424 0,3 W
P15F66624 1 W



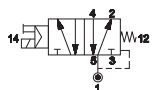
P15F74424 0,3 W
P15F76624 1 W



P15F84424 0,3 W
P15F86624 1 W

Electrical impulse - Threaded connections G1/8 - 15 mm connector

Single impulse

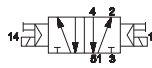


P15D24024 0,3 W
P15D26024 1 W

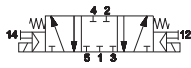


P15D24124 0,3 W
P15D26124 1 W

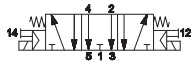
Double impulse



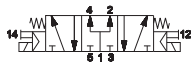
P15D24424 0,3 W
P15D26624 1 W



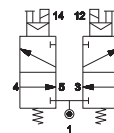
P15D34424 0,3 W
P15D36624 1 W



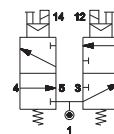
P15D44424 0,3 W
P15D46624 1 W



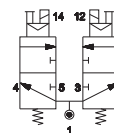
P15D54424 0,3 W
P15D56624 1 W



P15D64424 0,3 W
P15D66624 1 W



P15D74424 0,3 W
P15D76624 1 W



P15D84424 0,3 W
P15D86624 1 W

Integrated electrical connection



TIM1524	TIM151806	TIM1536	P15SF100	P15SF110	P15SF200	P15SF210
male connection module 25 poles 12+12 coils type sub-D	male connection module 25 poles 18 coils, side 14 6 coils, side 12 type sub-D	male connection module 37 poles 16+16 coils type sub-D	sub-base 1 place	sub-base 1 place 1-3-5 closed	sub-base 2 places	sub-base 2 places 1-3-5 closed
P15SF500	P15SF505	P15SF550	P15SF560	P15SF570	P15SS**..M	
left supply plate G1/4 for TIM module	right supply plate G1/4	pressure separator	closing plate for unused valve place	intermediate supply plate for threaded version	male bus connection card, ** = side 14 or 12 .. = 04, 06, 08 places	
P15SS**08MF	P15SS**04MFP	P15SS**04MP	P15STR01	P15STR02	P15STR05	
male/female bus connection card ** = side 14 or 12 8 places	male/female bus connection card extension ** = side 14 o 12 4 places	bus card extension ** = side 14 o 12 4 places	modular tie-rods 1 valve place	modular tie-rods 2 valve places	modular tie-rods 5 valve places	AZ4-SN004A No. 100 nuts M4 for tie-rods AZ4-VN0414 No. 100 screws M4x14 for tie-rods

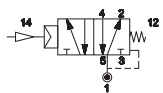
Electrical connection with external connector



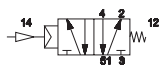
P15SF300	P15SF310	P15SF400	P15SF410	P15SF515	P15SF550	P15SF560
sub-base 1 place	sub-base 1 place 1-3-5 closed	sub-base 2 places	sub-base 2 places 1-3-5 closed	right/left supply plate G1/4	pressure separator	closing plate for unused valve place
P15SF570	P15STR01	P15STR02	P15STR05			
intermediate supply plate for threaded version	modular tie-rods 1 valve place	modular tie-rods 2 valve places	modular tie-rods 5 valve places	AZ4-SN004A No. 100 nuts M4 for tie-rods AZ4-VN0414 No. 100 screws M4x14 for tie-rods		

Pneumatic impulse - Body for sub-base mounting

Single impulse



P15B230

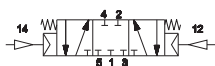


P15B231

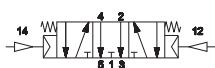
Double impulse



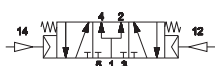
P15B233



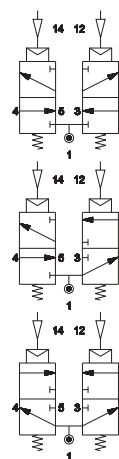
P15B333



P15B433



P15B533



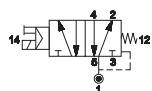
P15B633

P15B733

P15B833

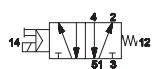
Electrical impulse - Body for sub-base mounting

Single impulse



P15B24024 0,3 W

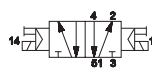
P15B26024 1 W



P15B24124 0,3 W

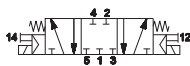
P15B26124 1 W

Double impulse



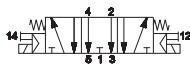
P15B24424 0,3 W

P15B26624 1 W



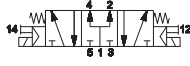
P15B34424 0,3 W

P15B36624 1 W



P15B44424 0,3 W

P15B46624 1 W



P15B54424 0,3 W

P15B56624 1 W

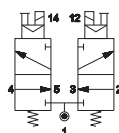
B10

NEW - B11



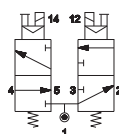
Low power consumption 0,3 W

Standard 1 W



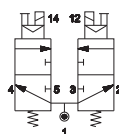
P15B64424 0,3 W

P15B66624 1 W



P15B74424 0,3 W

P15B76624 1 W



P15B84424 0,3 W

P15B86624 1 W

Integrated electrical connection



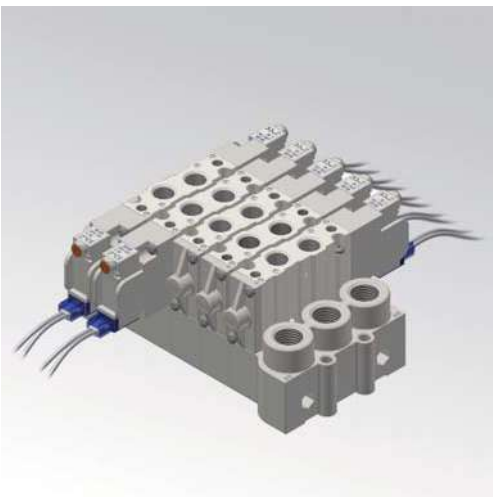
TIM1524	TIM151806	TIM1536	P15SB100	P15SB110	P15SB200	P15SB210
male connection module 25 poles 12+12 coils type sub-D	male connection module 25 poles 18 coils side 14 6 coils side 12 type sub-D	male connection module 37 poles 16+16 coils type sub-D	sub-base 1 place side outlets G1/8	sub-base 1 place side outlets G1/8 1-3-5 closed	sub-base 2 places side outlets G1/8	sub-base 2 places side outlets G1/8 1-3-5 closed
P15SB300	P15SB310	P15SB400	P15SB410	P15SB500	P15SB505	P15SB550
sub-base 1 place side outlets for push-in fittings	sub-base 1 place side outlets for push-in fittings 1-3-5 closed	sub-base 2 places side outlets for push-in fittings	sub-base 2 places side outlets for push-in fittings 1-3-5 closed	supply plate G1/4 for TIM module	right supply plate G1/4	pressure separator
P15SB560	P15SB570	P15SS**..M	P15SS**08MF	P15SS**04MFP	P15SS**04MP	
closing plate for unused valve place	intermediate supply plate for sub-base	male bus connection card ** = side 14 or 12 .. = 04, 06, 08 places	male/female bus connection card ** = side 14 or 12 8 places	male/female bus connection card extension ** = side 14 or 12 4 places	bus card connection extension ** = side 14 or 12 4 places	
P15STR01	P15STR02	P15STR05	GZR-V10004/06/08	AZ4-SN004A	AZ4-VN0414	
				No. 100 nuts M4 for tie-rods	No. 100 screws M4x14 for tie-rods	
modular tie-rods 1 valve place	modular tie-rods 2 valve places	modular tie-rods 5 valve places	straight fitting GZR-V10004 = tube Ø4 mm GZR-V10006 = tube Ø6 mm GZR-V10008 = tube Ø8 mm			

Electrical connections

D-535U40300 D-535U40500	AM-5109	TSCFN24S000 TSCFN36S000	TSCFN24S0300 TSCFN24S0500 TSCFN24S1000 TSCFN32S0300 TSCFN32S0500 TSCFN32S1000	TSCFN16D0300 TSCFN16D0500 TSCFN16D1000
single connector with cable 3-5 m	15 mm connector	female connector 25/37 poles, type sub-D, no cable M3x8 fixing screws	female connector 25/37 poles, type sub-D with cable 3-5-10 m M3x8 fixing screws	sub-D male/female flying connector prewired for 16 coils with cable Ø 8 mm (3-5-10 m length) suitable for dynamic laying M3x8 fixing screws

CHARACTERISTICS

Ambient temperature	-5 ÷ 50 °C	
Fluid	10 µm filtered air, with or without lubrication	
Commutation system	spool	
Max pressure	9 bar (electrical control) *	
	10 bar (pneumatic control)	
Connections	G1/8 (P15F) - G1/8 - tube Ø 4-6-8 (P15B)	
Nominal flow rate (NI/min)	800 (5/2) 720 (5/3) 720 (3/2+3/2)	
Valve body	zamak	
Seals	NBR	
Spool	aluminium	
Electropilot	B10 (0,3W) - B11 (1 W)	
Voltage	24 V DC (± 10%)	
Power consumption	B10 = 0,3 W, speed-up 1 W (25 ms) B11 = 1 W	
Protection degree	IP65	
Manual override	recessed button - 1 position	



* = At pressure higher than 7bar with B10 pilot (0.3W) it is recommended to use solenoid valves with external pilot supply

CODIFICATION KEY

P	1	5	F	2	8	0	2	4	
	1	2	3	4	5	6			

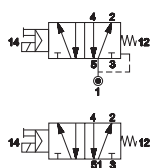
1 Series	2 Type	3 Control 14	4 Return 12
P15F = Threaded body P15B = Body for sub-base	2 = 5/2 3 = 5/3 c.c. 4 = 5/3 o.c. 5 = 5/3 p.c.	6 = 3/2+3/2 NC-NC 7 = 3/2+3/2 NC-NO 8 = 3/2+3/2 NO-NO	0 = Pneumomechanical spring 1 = Mechanical spring 8 = Electrical amplified in-line (0,3W) 9 = Electrical amplified in-line (1W)

5 Voltage	6 Option
24 = 24 V DC	D = External pilot supply on valve body (P15 = M5)

c.c. = closed centres o.c. = open centres p.c. = pressurized centres

Electrical impulse - Threaded connections G1/8

■ Single impulse



P15F28024 0,3 W
P15F29024 1 W

P15F28124 0,3 W
P15F29124 1 W

■ B10



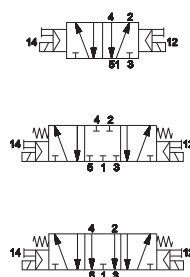
Low power consumption 0,3 W

■ NEW - B11



Standard 1 W

■ Double impulse

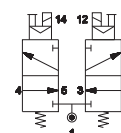


P15F28824 0,3 W
P15F29924 1 W

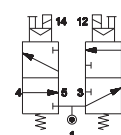
P15F38824 0,3 W
P15F39924 1 W

P15F48824 0,3 W
P15F49924 1 W

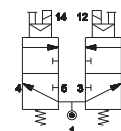
P15F58824 0,3 W
P15F59924 1 W



P15F68824 0,3 W
P15F69924 1 W



P15F78824 0,3 W
P15F79924 1 W



P15F88824 0,3 W
P15F89924 1 W

Electrical connection with external connector

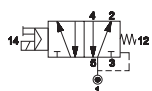
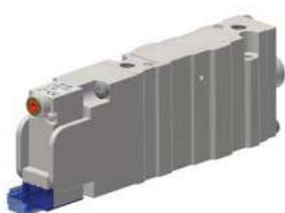


P15SF300	P15SF310	P15SF400	P15SF410	P15SF515	P15SF550	P15SF560
sub-base 1 place	sub-base 1 place 1-3-5 closed	sub-base 2 places	sub-base 2 places 1-3-5 closed	right/left supply plate G1/4	pressure separator	closing plate for unused valve place

P15SF570	P15STR01	P15STR02	P15STR05	AZ4-SN004A	AZ4-VN0414
				No. 100 nuts M4 for tie-rods	No. 100 screws M4x14 for tie-rods
intermediate supply plate for threaded version	modular tie-rods 1 valve place	modular tie-rods 2 valve places	modular tie-rods 5 valve places		

Electrical impulse - Body for sub-base mounting

Single impulse



P15B28024 0,3 W
P15B29024 1 W



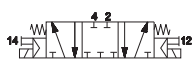
P15B28124 0,3 W
P15B29124 1 W

B10	NEW - B11
Low power consumption 0,3 W	Standard 1 W

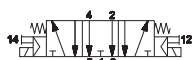
Double impulse



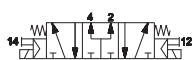
P15B28824 0,3 W
P15B29924 1 W



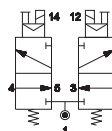
P15B38824 0,3 W
P15B39924 1 W



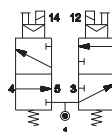
P15B48824 0,3 W
P15B49924 1 W



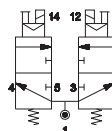
P15B58824 0,3 W
P15B59924 1 W



P15B68824 0,3 W
P15B69924 1 W



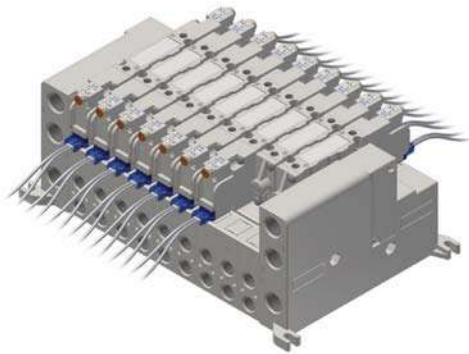
P15B78824 0,3 W
P15B79924 1 W



P15B88824 0,3 W
P15B89924 1 W

Electrical connection with external connector

3



P15SB100 P15SB110 P15SB200 P15SB210 P15SB300 P15SB310 P15SB400

sub-base 1 place side outlets G1/8	sub-base 1 place side outlets G1/8 1-3-5 closed	sub-base 2 places side outlets G1/8	sub-base 2 places side outlets G1/8 1-3-5 closed	sub-base 1 place side outlets for GZR push-in fittings	sub-base 1 place side outlets for GZR push-in fittings 1-3-5 closed	sub-base 2 places side outlets for GZR push-in fittings

P15SB410 P15SB502 P15SB505 P15SB550 P15SB560 P15SB570

sub-base 2 places side outlets for GZR push-in fittings 1-3-5 closed	left supply plate G1/4	right supply plate G1/4	pressure separator	closing plate for unused valve place	intermediate supply plate for sub-base

P15STR01 P15STR02 P15STR05 GZR-V10004/06/08

modular tie-rods 1 valve place	modular tie-rods 2 valve places	modular tie-rods 5 valve places	straight fitting GZR-V10004 = tube Ø4 mm GZR-V10006 = tube Ø6 mm GZR-V10008 = tube Ø8 mm

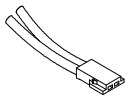
AZ4-SN004A

No. 100 nuts M4 for tie-rods

AZ4-VN0414

No. 100 screws M4x14 for tie-rods

D-530-30/50/200



Miniature connector with loose cables
D-530-30 = cable length 300 mm
D-530-50 = cable length 500 mm
D-530-200 = cable length 2000 mm



HIGH FLOW RATE

Flow rate higher than **800 NI/min**

REDUCED DIMENSIONS

Body width 15 mm

COMPLETE SOLUTION

Versions available 5/2 - 5/3 - 3/2+3/2

P15EF



P15EB



P15EF

Threaded ports (G1/8)



P15EB

For sub-base (G1/8 - Tube 4-6-8)



15 mm Electropilot - A series
UNIVER Original



Interchangeable coil - U05 type
90° x 90° revolvable
(12 - 24 V DC, 24 - 48 - 110 - 230 V AC)



Manual override (upon request)
Monostable + 2 positions



Sub-base mounting
Easy installation by means of 2 screws



Single mounting
Side holes on valve body

CHARACTERISTICS

Ambient temperature	-5 ÷ 50 °C
Fluid	10 µm filtered air, with or without lubrication
Commutation system	spool
Max pressure	9 bar
Connections	G1/8
Nominal flow rate (NI/min)	800 (5/2) 720 (5/3) 720 (3/2+3/2)
Valve body	zamak
Seals	NBR
Spool	aluminium
Electropilot	A series (15 mm)
Coil	U05 series
Voltage	12 V DC - 24 V DC - 24 V AC - 48 V AC - 110 V AC - 230 V AC
Power consumption	2 W (DC) 2,3 VA (AC)
Protection degree	IP65
Manual override	impulse screw - 1-2 positions


CODIFICATION KEY

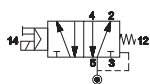
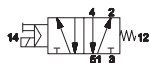
P	1	5	E	F	2	5	5	2	4	
	1	2	3	4	5	6				

1 Series P15EF = COMPACT Valves - Threaded body G1/8 A series electropilot (15 mm)	2 Type 2 = 5/2 6 = 3/2+3/2 NC-NC 3 = 5/3 c.c. 7 = 3/2+3/2 NC-NO 4 = 5/3 o.c. 8 = 3/2+3/2 NO-NO 5 = 5/3 p.c.	3 Control 14 5 = Electrical amplified 15 mm
4 Return 12 0 = Pneumomechanical spring 1 = Mechanical spring 5 = Electrical amplified 15 mm	5 Voltage 12 = 12 V DC 48 = 48 V AC 24 = 24 V DC 11 = 110 V AC 34 = 24 V AC 23 = 230 V AC	6 Option C = 2-position manual override (upon request) D = External pilot supply

c.c. = closed centres o.c. = open centres p.c. = pressurized centres

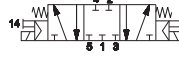
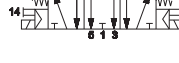
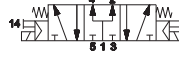
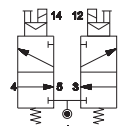
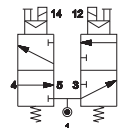
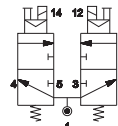
Electrical impulse - Threaded connection G1/8

■ Single impulse


P15EF250**

P15EF251**

DIN C (8 mm)
 For further information please contact
 our Sales Office

■ Double impulse


P15EF255**

P15EF355**

P15EF455**

P15EF555**

P15EF655**

P15EF755**

P15EF855**

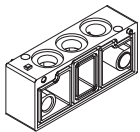
** = Voltage 12 V DC - 24 V DC - 24 V AC - 48 V AC - 110 V AC - 230 V AC (Example: P15EF25024)

Solenoid valves are supplied with coils, without connectors

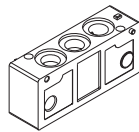
Electrical connection with external connector



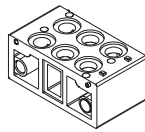
P15SF300 P15SF310 P15SF400 P15SF410 P15SF515 P15SF550 P15SF560



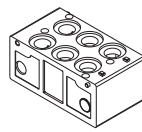
sub-base 1 place



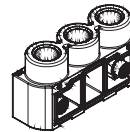
sub-base 1 place
1-3-5 closed



sub-base 2 places



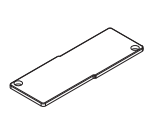
sub-base 2 places
1-3-5 closed



right/left supply plate
G1/4

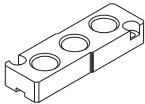


pressure separator



closing plate for
unused valve place

P15SF570 P15STR01 P15STR02 P15STR05



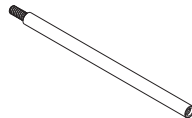
intermediate supply plate
for threaded version



modular tie-rod
1 valve place



modular tie-rod
2 valve places



modular tie-rod
5 valve places

AZ4-SN004A

No. 100 nuts M4 for tie-rods

AZ4-VN0414

No. 100 screws M4x14 for tie-rods

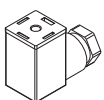
Pre-assembled sub-base



Part No.	Positions
P15SF499-02	2
P15SF499-03	3
P15SF499-04	4
P15SF499-05	5
P15SF499-06	6
P15SF499-07	7
P15SF499-08	8
P15SF499-09	9
P15SF499-10	10

Pre-assembled sub-bases include seals and screws for valve assembly

Electrical connections



AM-5109

15 mm connector

CHARACTERISTICS

Ambient temperature	-5 ÷ 50 °C
Fluid	10 µm filtered air, with or without lubrication
Commutation system	spool
Max pressure	9 bar
Connections	G1/8
Nominal flow rate (NI/min)	800 (5/2) 720 (5/3) 720 (3/2+3/2)
Valve body	zamak
Seals	NBR
Spool	aluminium
Electropilot	A series (15 mm)
Coil	U05 series
Voltage	12 V DC - 24 V DC - 24 V AC - 48 V AC - 110 V AC - 230 V AC
Power consumption	2 W (DC) 2,3 VA (AC)
Protection degree	IP65
Manual override	impulse screw - 1-2 positions


CODIFICATION KEY

P	1	5	E	B	2	5	5	2	4	
	1	2	3	4	5	6				

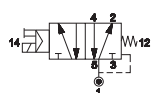
1 Series	2 Type	3 Control 14
P15EB = COMPACT Valves for sub-base mounting A series electropilot (15 mm)	2 = 5/2 3 = 5/3 c.c. 4 = 5/3 o.c. 5 = 5/3 p.c.	5 = Electrical amplified 15 mm

4 Return 12	5 Voltage	6 Variant
0 = Pneumomechanical spring 1 = Mechanical spring 5 = Electrical amplified 15 mm	12 = 12 V DC 48 = 48 V AC 24 = 24 V DC 11 = 110 V AC 54 = 24 V AC 23 = 230 V AC	C = 2-position manual override (upon request) D = External pilot supply

c.c. = closed centres o.c. = open centres p.c. = pressurized centres

Electrical impulse - Body for sub-base mounting - 15 mm connector

■ Single impulse

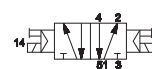
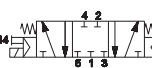
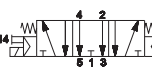
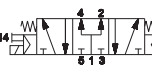
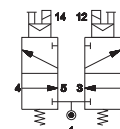
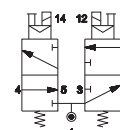
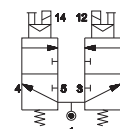

P15EB250**

P15EB251**

DIN C (8 mm)

For further information please contact our Sales Office

■ Double impulse


P15EB255**

P15EB355**

P15EB455**

P15EB555**

P15EB655**

P15EB755**

P15EB855**

** = Voltage 12 V DC - 24 V DC - 24 V AC - 48 V AC - 110 V AC - 230 V AC (Example: P15EB25024)

Solenoid valves are supplied with coils, without connectors

Electrical connection with external connector



P15SB100 P15SB110 P15SB200 P15SB210 P15SB300 P15SB310 P15SB400

sub-base 1 place side outlets G1/8	sub-base 1 place side outlets G1/8 1-3-5 closed	sub-base 2 places side outlets G1/8	sub-base 2 places side outlets G1/8 1-3-5 closed	sub-base 1 place side outlets for GZR push-in fittings	sub-base 1 place side outlets for GZR push-in fittings 1-3-5 closed	sub-base 2 places side outlets for GZR push-in fittings

P15SB410 P15SB502 P15SB505 P15SB550 P15SB560 P15SB570

sub-base 2 places side outlets for GZR push-in fittings 1-3-5 closed	left supply plate G1/4	right supply plate G1/4	pressure separator	closing plate for unused valve place	intermediate supply plate for sub-base

P15STR01 P15STR02 P15STR05 GZR-V10004/06/08

modular tie-rods 1 valve place	modular tie-rods 2 valve places	modular tie-rods 5 valve places	straight fitting GZR-V10004 = tube Ø4 mm GZR-V10006 = tube Ø6 mm GZR-V10008 = tube Ø8 mm

AZ4-SN004A
No. 100 nuts M4 for tie-rods

AZ4-VN0414
No. 100 screws M4x14 for tie-rods

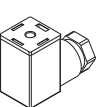
Pre-assembled sub-base



Part No.	Positions
P15SB499-02	2
P15SB499-03	3
P15SB499-04	4
P15SB499-05	5
P15SB499-06	6
P15SB499-07	7
P15SB499-08	8
P15SB499-09	9
P15SB499-10	10

Pre-assembled sub-bases include seals and screws for valve assembly

Electrical connections



AM-5109

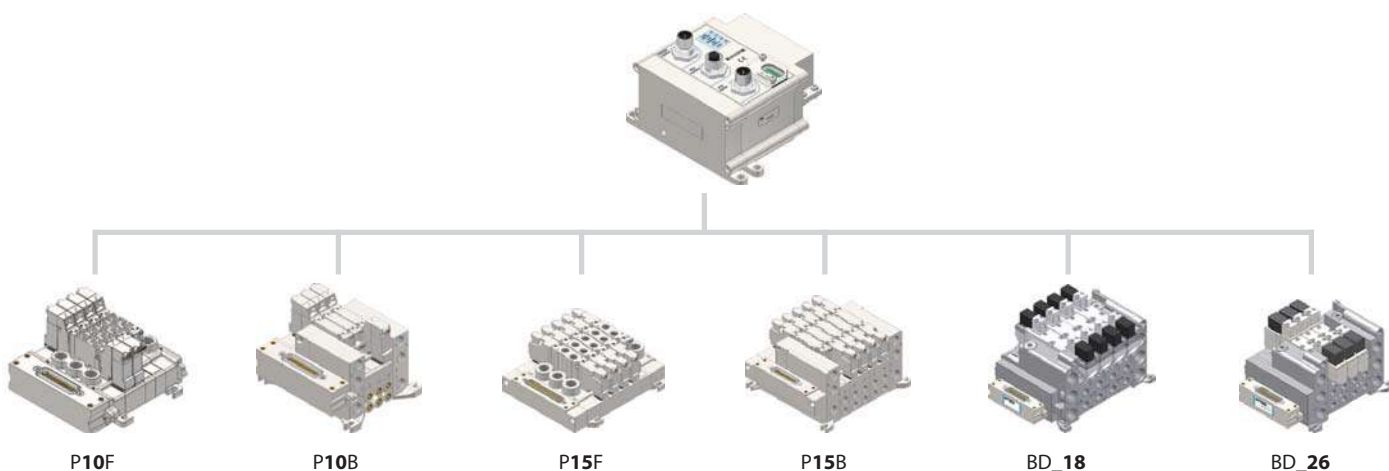
15 mm connector

CHARACTERISTICS







Controlled devices	Manifolds, Digital input M12/M8, Output M12
Handling capacity	Max 64 inputs + 64 outputs (PROFIBUS-DP, CANopen, DeviceNet)
	Max 64 inputs + 88 outputs (PROFINET, EtherNet/IP, EtherCAT)
Integrated configuration	BD series (VDMA) 18 - 26 mm P10 - P15 series (COMPACT)
Distributed configuration	Remote expansion modules for valve manifolds with sub-D 25 plug-in
FieldBus protocols	CANopen, DeviceNet, PROFINET, PROFIBUS-DP, EtherNet/IP, EtherCAT



Serial module for all manifold models



Serial module

<p>■ CANopen</p>  <table border="1"> <tr> <td>Part No.</td> <td>TCXC</td> </tr> <tr> <td>Auxiliary power supply</td> <td>1 x M12 - 4 pins male</td> </tr> <tr> <td>Fieldbus</td> <td>1 x M12 - 5 pins male</td> </tr> <tr> <td>Connectors</td> <td>1 x M12 - 5 pins female</td> </tr> <tr> <td>Diagnostics</td> <td>Optical, Primary, Extended</td> </tr> <tr> <td>Capacity max I/O</td> <td>64 In - 40 Out 24 coils</td> </tr> <tr> <td>LSS Slave</td> <td>supported</td> </tr> </table>	Part No.	TCXC	Auxiliary power supply	1 x M12 - 4 pins male	Fieldbus	1 x M12 - 5 pins male	Connectors	1 x M12 - 5 pins female	Diagnostics	Optical, Primary, Extended	Capacity max I/O	64 In - 40 Out 24 coils	LSS Slave	supported	<p>■ PROFIBUS-DP</p>  <table border="1"> <tr> <td>Part No.</td> <td>TCXP</td> </tr> <tr> <td>Auxiliary power supply</td> <td>1 x M12 - 4 pins male</td> </tr> <tr> <td>Fieldbus</td> <td>1 x M12 - 4 pins male B code</td> </tr> <tr> <td>Connectors</td> <td>1 x M12 - 4 pins female B code</td> </tr> <tr> <td>Diagnostics</td> <td>Optical, Primary, Extended</td> </tr> <tr> <td>Capacity max I/O</td> <td>64 In - 40 Out 24 coils</td> </tr> </table>	Part No.	TCXP	Auxiliary power supply	1 x M12 - 4 pins male	Fieldbus	1 x M12 - 4 pins male B code	Connectors	1 x M12 - 4 pins female B code	Diagnostics	Optical, Primary, Extended	Capacity max I/O	64 In - 40 Out 24 coils
Part No.	TCXC																										
Auxiliary power supply	1 x M12 - 4 pins male																										
Fieldbus	1 x M12 - 5 pins male																										
Connectors	1 x M12 - 5 pins female																										
Diagnostics	Optical, Primary, Extended																										
Capacity max I/O	64 In - 40 Out 24 coils																										
LSS Slave	supported																										
Part No.	TCXP																										
Auxiliary power supply	1 x M12 - 4 pins male																										
Fieldbus	1 x M12 - 4 pins male B code																										
Connectors	1 x M12 - 4 pins female B code																										
Diagnostics	Optical, Primary, Extended																										
Capacity max I/O	64 In - 40 Out 24 coils																										
<p>■ DeviceNet</p>  <table border="1"> <tr> <td>Part No.</td> <td>TCXD</td> </tr> <tr> <td>Auxiliary power supply</td> <td>1 x 7/8" - 4 pins male</td> </tr> <tr> <td>Fieldbus</td> <td>1 x 7/8" - 5 pins male</td> </tr> <tr> <td>Connectors</td> <td>1 x 7/8" - 5 pins female</td> </tr> <tr> <td>Diagnostics</td> <td>Optical, Primary, Extended</td> </tr> <tr> <td>Capacity max I/O</td> <td>64 In - 40 Out 24 coils</td> </tr> </table>	Part No.	TCXD	Auxiliary power supply	1 x 7/8" - 4 pins male	Fieldbus	1 x 7/8" - 5 pins male	Connectors	1 x 7/8" - 5 pins female	Diagnostics	Optical, Primary, Extended	Capacity max I/O	64 In - 40 Out 24 coils	<p>■ EtherNet/IP</p>  <table border="1"> <tr> <td>Part No.</td> <td>TCXEN</td> </tr> <tr> <td>Auxiliary power supply</td> <td>1 x M12 - 4 pins male</td> </tr> <tr> <td>Fieldbus</td> <td>2 x M12 - 4 pins female D code</td> </tr> <tr> <td>Connectors</td> <td></td> </tr> <tr> <td>Diagnostics</td> <td>Optical, Primary, Extended</td> </tr> <tr> <td>Capacity max I/O</td> <td>64 In - 64 Out 24 coils</td> </tr> </table>	Part No.	TCXEN	Auxiliary power supply	1 x M12 - 4 pins male	Fieldbus	2 x M12 - 4 pins female D code	Connectors		Diagnostics	Optical, Primary, Extended	Capacity max I/O	64 In - 64 Out 24 coils		
Part No.	TCXD																										
Auxiliary power supply	1 x 7/8" - 4 pins male																										
Fieldbus	1 x 7/8" - 5 pins male																										
Connectors	1 x 7/8" - 5 pins female																										
Diagnostics	Optical, Primary, Extended																										
Capacity max I/O	64 In - 40 Out 24 coils																										
Part No.	TCXEN																										
Auxiliary power supply	1 x M12 - 4 pins male																										
Fieldbus	2 x M12 - 4 pins female D code																										
Connectors																											
Diagnostics	Optical, Primary, Extended																										
Capacity max I/O	64 In - 64 Out 24 coils																										
<p>■ PROFINET</p>  <table border="1"> <tr> <td>Part No.</td> <td>TCXPN</td> </tr> <tr> <td>Auxiliary power supply</td> <td>1 x M12 - 4 pins male</td> </tr> <tr> <td>Fieldbus</td> <td>2 x M12 - 4 pins female</td> </tr> <tr> <td>Connectors</td> <td>D code</td> </tr> <tr> <td>Diagnostics</td> <td>Optical, Primary, Extended</td> </tr> <tr> <td>Capacity max I/O</td> <td>64 In - 72 Out 24 coils</td> </tr> </table>	Part No.	TCXPN	Auxiliary power supply	1 x M12 - 4 pins male	Fieldbus	2 x M12 - 4 pins female	Connectors	D code	Diagnostics	Optical, Primary, Extended	Capacity max I/O	64 In - 72 Out 24 coils	<p>■ EtherCAT</p>  <table border="1"> <tr> <td>Part No.</td> <td>TCXEC</td> </tr> <tr> <td>Auxiliary power supply</td> <td>1 x M12 - 4 pins male</td> </tr> <tr> <td>Fieldbus</td> <td>2 x M12 - 4 pins female D code</td> </tr> <tr> <td>Connectors</td> <td></td> </tr> <tr> <td>Diagnostics</td> <td>Optical, Primary, Extended</td> </tr> <tr> <td>Capacity max I/O</td> <td>64 In - 64 Out 24 coils</td> </tr> </table>	Part No.	TCXEC	Auxiliary power supply	1 x M12 - 4 pins male	Fieldbus	2 x M12 - 4 pins female D code	Connectors		Diagnostics	Optical, Primary, Extended	Capacity max I/O	64 In - 64 Out 24 coils		
Part No.	TCXPN																										
Auxiliary power supply	1 x M12 - 4 pins male																										
Fieldbus	2 x M12 - 4 pins female																										
Connectors	D code																										
Diagnostics	Optical, Primary, Extended																										
Capacity max I/O	64 In - 72 Out 24 coils																										
Part No.	TCXEC																										
Auxiliary power supply	1 x M12 - 4 pins male																										
Fieldbus	2 x M12 - 4 pins female D code																										
Connectors																											
Diagnostics	Optical, Primary, Extended																										
Capacity max I/O	64 In - 64 Out 24 coils																										

Configurable expansion modules

<p>■ TC8I412 No. 8 Digital inputs M12</p>	<p>■ TC16I812 No. 16 Digital inputs M12</p>	<p>■ TC8U412 No. 8 Digital outputs M12</p>	<p>■ TC8I808 No. 8 Digital inputs M8</p>	<p>■ TCR32ID No. 16+16 Digital inputs</p>
				<p>■ TCR32UD No. 16+16 Digital outputs</p>
				<p>■ TCR1616 No. 16 Digital inputs + No. 16 Digital outputs</p>

TZ-F4M12	TZ-F5M12	TZ-M5M12/T	TZ-F478	TZ-F578
-----------------	-----------------	-------------------	----------------	----------------



<p>CANopen, ProfiBus, ProfiNet EtherNet/IP, EtherCat Power Supply Connector M12 female 4 poles</p>	<p>CanOpen Input Bus M12 female 5 poles</p>	<p>CanOpen Output Bus M12 male 5 poles</p> <p>TZ-M5M12-T ProfiBus, Bus terminating connector M12 male 5 poles</p>	<p>DeviceNet Power Supply Connector 7/8 female 4 poles</p>	<p>DeviceNet Input Bus 7/8 female 5 poles</p>
--	---	--	--	---

TZ-M578/T	TZ-F5M12-B	TZ-M4M12-B/BT	TZ-M4M12-D	TSCFN16...
------------------	-------------------	----------------------	-------------------	-------------------



<p>TZ-M578 DeviceNet Input Bus 7/8 male 5 poles</p>	<p>ProfiBus Input Bus M12 female 5 poles B-code</p>	<p>TZ-M4M12-B ProfiBus Output Bus M12 male 4 poles B-code</p> <p>TZ-M4M12-BT ProfiBus, Bus terminating connector M12 male 4 poles B-code</p>	<p>ProfiNet, EtherNet/IP, EtherCat Input/Output Bus M12 male 4 poles D-code</p>	<p>TSCFN16D0300 Prewired cable, sub-D, 25 poles, 16 signals 3 m</p> <p>TSCFN16D0500 Prewired cable, sub-D 25 poles, 16 signals 5 m</p> <p>TSCFN16D1000 Prewired cable, sub-D 25 poles, 16 signals 10 m</p>
--	---	--	---	---

Assembly scheme

- 1 FieldBus Module
- 2 Auxiliary Module - Inputs 8 x M8
- 3 Auxiliary Module - Inputs 4 x M12
- 4 Auxiliary Module - Outputs 4 x M12
- 5 TCXX end cover included (1 pc)
- 6 TCXX cover screws included (4 pcs.)
- 7 I/O tie-rods included (4 pcs.)
- 8 TFP010 1 mm for valves P10F-P15F (2 pcs.)
TFP060 6 mm for valves BD 18-26 mm (2 pcs.)
TFP178 17,5 mm for valves P10B (2 pcs.)
TFP257 25,7 mm for valves P15B (2 pcs.)
- 9 Adaptor for 18-26 mm VDMA Manifold

MATCHING TABLE - COILS/ELECTROPILOTS - ELECTROPILOTS/SOLENOID VALVES			Electropilots					
			A (U05)	B (U04)	AA (U1)	AA (U3)		AB (U2)
Coils	U04	10 mm		■				
	U05	15 mm	■					
	U1	22 mm			■			
	U2	30 mm					■	■
	U3	30 mm				■	■	
Solenoid valves	BE	ISO 1 - ISO 2	■ (a)				■	
		ISO 3 - ISO 4						R
	AE	ISO 1 - ISO 2			■	■		
	BD	ISO 01 26 mm	■					
		ISO 02 18 mm						
	AC-N	Interface NAMUR			■	■		
	CL	G1/8			■	■		
		CM	G1/4			■	■	
	COMP 2/4		■					
	G6	G1/8	■	■				
	GL6	sub-base						
	G7	G1/8	R		■	■		
	PS	tube Ø 4						
		tube Ø 6		■				
		tube Ø 8						
	AC	G1/8 - G1/4			■	■		
		G1/2			R	R	■	
	AF	G1/8			■	■		
G1/4 - G3/8				■	■	■		
G1/2 ÷ G1				R	R	■		
AG	G1 1/2						■	
	G1/8			■	■			
AG	G1/4 ÷ G1			R	R	■		
	G1 1/2						■	
P15E	G1/8	■						

■ = Standard R = Upon request (a) = Connector M12

10 mm U04 Coils for B series electropilots

■ With integrated 90° upward connector		■ With in-line connector	
	DE-352 24 V DC 1,2 W DE-452 24 V DC 1,35 W (with led) DE-355 24 V DC 0,5 W NEW	Connector: D-500 D-530-... D-535-...	
			DE-552 24 V DC 1,2 W DE-652 24 V DC 1,35 W (with led) DE-555 24 V DC 0,5 W NEW
			Connector: D-500 D-530-... D-535-...
■ With loose cables (length 300 mm)		■ With in-line connector with protecting cover for complete tightness	
	DE-052L030 24 V DC 1,2 W		
			DE-642I 12 V DC 1,35 W DE-652I 24 V DC 1,35 W (with led) DE-655I 24 V DC 0,5 W NEW
			Connector: D-530C-100 D-530C-200

15 mm U05 Coils for A series electropilot

■ with integrated 90° upward connector



DD-351 24 V DC 2 W
Connector:
 D-500
 D-530-...
 D-535-...

■ with integrated 90° downward connector



DD-151 24 V DC 2 W
Connector:
 D-500
 D-530-...
 D-535-...

■ with in-line connector



DD-551 24 V DC 2 W
Connector:
 D-500
 D-530-...
 D-535-...

■ with loose cables



DD-051L030 12 V DC 2 W
DD-052L030 24 V DC 2,5 W

■ 15 mm - Faston



DD-013 230 V AC 50/60 Hz 3,5 VA
DD-040 24 V AC 50/60 Hz 2,3 VA
DD-041 12 V DC 2 W
DD-042 12 V DC 2,5 W
DD-050 48 V AC 50/60 Hz 2,3 VA

Connector:
 AM-5109

DD-051 24 V DC 2 W
DD-052 24 V DC 2,5 W
DD-060 110 V AC 50/60 Hz 2,3 VA
DD-070 230 V AC 50/60 Hz 2,3 VA

U1 - U2 - U3 Coil

■ 22 mm (U1)



DA-0050 12 V DC 3,5 W
DA-0051 24 V DC 3,5 W
DA-0106 24 V AC 50/60 Hz 5 VA
DA-0108 110 V AC 50/60 Hz 5 VA
DA-0124 230 V AC 50/60 Hz 5 VA

■ 30 mm (U2)



DB-0501 12 V DC 11 W
DB-0502 24 V DC 11 W
DB-0507 24 V AC 50/60 Hz 10 VA
DB-0509 110 V AC 50/60 Hz 10 VA
DB-0510 230 V AC 50/60 Hz 10 VA

■ 30 mm (U3)



DC-0301 12 V DC 2,5 W
DC-0302 24 V DC 2,5 W
DC-0307 24 V AC 50/60 Hz 3,3 VA
DC-0309 110 V AC 50/60 Hz 3,3 VA
DC-0310 230 V AC 50/60 Hz 3,3 VA



U1-U2-U3 coils are certified in compliance with CSA regulation, certificate n. LR 113373-1.

For coils certified in compliance with UL regulation, please contact our Sales Office

Connectors

■ Miniature connector without wires



D-500
Coil:
 U04/U05

■ Miniature connector with loose cables



D-530-30
D-530-50
D-530-200
Coil:
 U04/U05

■ Miniature connector with cable



D-535-30
D-535-50
D-535-200
Coil:
 U04/U05

■ 15 mm Connector



AM-5109
Coil:
 U05

■ 20 mm Connector



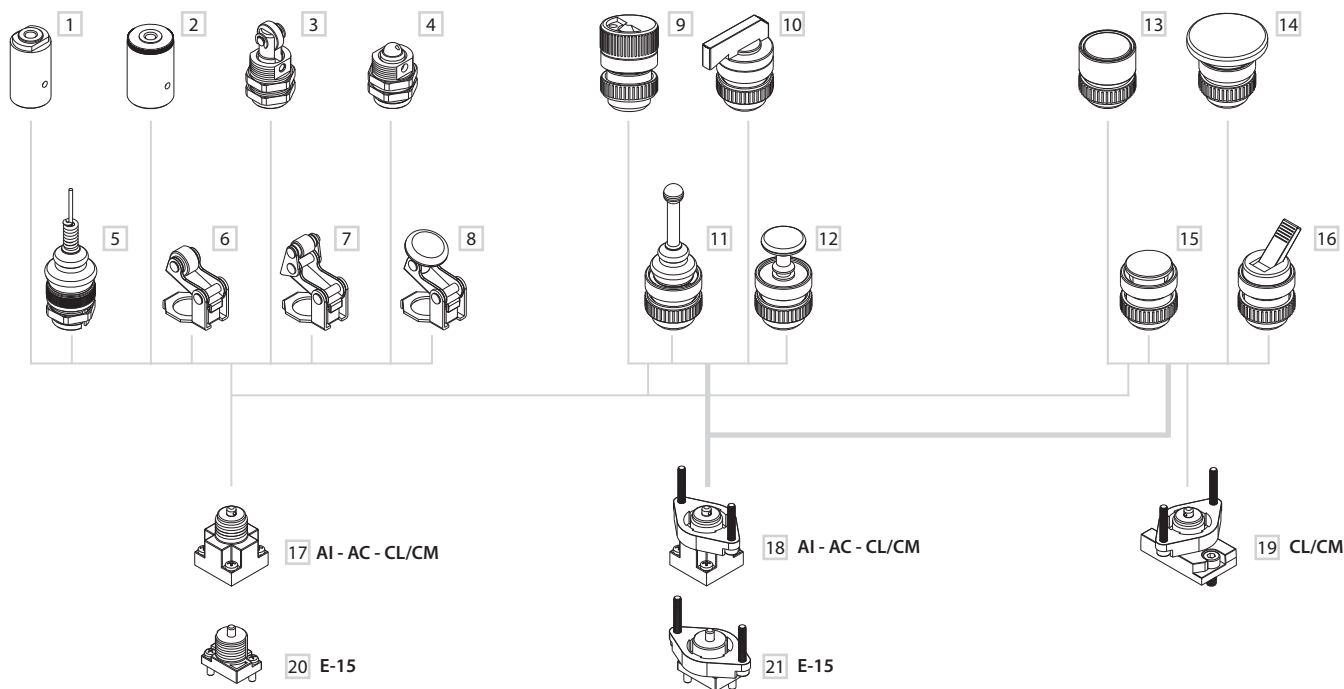
AM-5110
Coil:
 U1

■ 30 mm Connector



AM-5111
Coil:
 U2/U3

Operator/button modularity



PNEUMATIC / MECHANICAL OPERATORS

- 1 Pneumatic operator
- 2 Amplified pneumatic operator
- 3 Roller operator 1 position
- 4 Ball-push operator 1 position
- 5 Omni-directional antenna 1 position
- 6 Roller lever operator 1 position
- 7 Articulated roller lever operator 1 position
- 8 Key operator 1 position

MANUAL OPERATORS

- 9 Rotating selector
- 10 Rotating lever selector
- 11 Omni-directional operator
- 12 Push-pull operator
- 13 Recessed button
- 14 Head button
- 15 Button
- 16 Lever

OVERRIDE

- 17 Threaded indirect operation
- 18 Indirect panel operation
- 19 Direct panel operation
- 20 Ball-push direct operation
- 21 Ball-push direct panel operation

Recessed button



- 1 Position
 - AI-3511 black ■
 - AI-3512 red ■
 - AI-3513 green ■
- For panel mounting 1 Position
 - AI-3511Q black ■
 - AI-3512Q red ■
 - AI-3513Q green ■

Head button



- 1 Position
 - AI-3514 red ■
 - AI-3516 black ■
- For panel mounting 1 Position
 - AI-3514Q red ■
 - AI-3516Q black ■
- 2 Positions
 - AI-3514D red ■
 - AI-3516D black ■
- For panel mounting 2 Positions
 - AI-3514QD red ■
 - AI-3516QD black ■

Button



- 1 Position
 - AI-3515 green ■
 - AI-3517 red ■
 - AI-3519 black ■
- For panel mounting 1 Position
 - AI-3515Q green ■
 - AI-3517Q red ■
 - AI-3519Q black ■

Lever



- 2 Positions
 - AI-3524 black ■
- For panel mounting 2 Positions
 - AI-3524Q black ■

Rotating selector for accident prevention

	■ With light 1 position	■ With light 2 positions
	AI-3521 black ■	AI-3520 black ■
	■ For panel mounting with light 1 position	■ For panel mounting with light 2 positions
	AI-3521Q black ■	AI-3520Q black ■

Rotating lever selector

	■ With light 1 position	■ With light 2 positions
	AI-3523 black ■	AI-3522 black ■
	■ For panel mounting with light 1 position	■ For panel mounting with light 2 positions
	AI-3523Q black ■	AI-3522Q black ■

Omni-directional lever

Push-pull operator

	■ With centre return 1 position		■ 2 positions
	AI-3525 black ■		AI-3526 black ■
	■ For panel mounting with centre return 1 position		■ For panel mounting 2 positions
	AI-3525Q black ■		AI-3526Q black ■

AI-3529



reducer for Ø 30,5 to Ø 22,5, to be used with AI-35..Q limit switches

Pneumatic and mechanical operators

■ Pneumatic operator	■ Roller operator with dust protection	■ Omni-directional antenna 1 position with centre return	■ Roller lever 1 position
→-- [AI-3550	[AI-3560	[AI-3563	[AI-3570
■ Amplified pneumatic operator	■ Ball operator with dust protection		■ Articulated one-way roller lever 1 position
[AI-3551	[AI-3562		[AI-3571
			■ Push button 1 position
			[AI-3572

YR240 Brass ball valve 2/2 with rotary actuator

■ Double/single acting



Temperature: -20 ÷ 120 °C
Fluid: air, water, etc.
Working pressure: Max 40 bar
 (based on working temperature)

Double acting			Single acting		
Part No.	Ø	DN	Part No.	Ø	DN
YR240008DA	8	G1/4	YR240008SR	8	G1/4
YR240010DA	10	G3/8	YR240010SR	10	G3/8
YR240015DA	15	G1/2	YR240015SR	15	G1/2
YR240020DA	20	G3/4	YR240020SR	20	G3/4
YR240025DA	25	G1	YR240025SR	25	G1
YR240032DA	32	G1 1/4	YR240032SR	32	G1 1/4
YR240040DA	40	G1 1/2	YR240040SR	40	G1 1/2
YR240050DA	50	G2	YR240050SR	50	G2
YR240065DA	65	G2 1/2	YR240065SR	65	G2 1/2
YR240080DA	80	G3	YR240080SR	80	G3
YR240100DA	100	G4	YR240100SR	100	G4

YR250 Ball valve 2/2 AISI 316 with manual lever or rotary actuator

■ With manual lever



Part No.	Ø	DN
YR250008LM	8	G1/4
YR250010LM	10	G3/8
YR250015LM	15	G1/2
YR250020LM	20	G3/4
YR250025LM	25	G1
YR250032LM	32	G1 1/4
YR250040LM	40	G1 1/2
YR250050LM	50	G2
YR250065LM	65	G2 1/2
YR250080LM	80	G3

■ Double/single acting



Temperature: -25 ÷ 200 °C
Fluid: air, water, chemical agents, etc.
Working pressure: Max 63 bar
 (based on working temperature)

Double acting			Single acting		
Part No.	Ø	DN	Part No.	Ø	DN
YR250008DA	8	G1/4	YR250008SR	8	G1/4
YR250010DA	10	G3/8	YR250010SR	10	G3/8
YR250015DA	15	G1/2	YR250015SR	15	G1/2
YR250020DA	20	G3/4	YR250020SR	20	G3/4
YR250025DA	25	G1	YR250025SR	25	G1
YR250032DA	32	G1 1/4	YR250032SR	32	G1 1/4
YR250040DA	40	G1 1/2	YR250040SR	40	G1 1/2
YR250050DA	50	G2	YR250050SR	50	G2
YR250065DA	65	G2 1/2	YR250065SR	65	G2 1/2
YR250080DA	80	G3	YR250080SR	80	G3

YR260 Ball valve 2/2 AISI 316 (3 pieces) with manual lever or rotary actuator

■ With manual lever



Part No.	Ø	DN
YR260008LM	8	G1/4
YR260010LM	10	G3/8
YR260015LM	15	G1/2
YR260020LM	20	G3/4
YR260025LM	25	G1
YR260032LM	32	G1 1/4
YR260040LM	40	G1 1/2
YR260050LM	50	G2
YR260065LM	65	G2 1/2
YR260080LM	80	G3

■ Double/single acting



Temperature: -25 ÷ 200 °C
Fluid: air, water, chemical agents, etc.
Working pressure: Max 63 bar
 (based on working temperature)

Double acting			Single acting		
Part No.	Ø	DN	Part No.	Ø	DN
YR260008DA	8	G1/4	YR260008SR	8	G1/4
YR260010DA	10	G3/8	YR260010SR	10	G3/8
YR260015DA	15	G1/2	YR260015SR	15	G1/2
YR260020DA	20	G3/4	YR260020SR	20	G3/4
YR260025DA	25	G1	YR260025SR	25	G1
YR260032DA	32	G1 1/4	YR260032SR	32	G1 1/4
YR260040DA	40	G1 1/2	YR260040SR	40	G1 1/2
YR260050DA	50	G2	YR260050SR	50	G2
YR260065DA	65	G2 1/2	YR260065SR	65	G2 1/2
YR260080DA	80	G3	YR260080SR	80	G3

YR270 L-shaped ball valve 3/2 AISI 316 with manual lever or rotary actuator

■ With manual lever



Part. No	Ø	DN
YR270008LM	8	G1/4
YR270010LM	10	G3/8
YR270015LM	15	G1/2
YR270020LM	20	G3/4
YR270025LM	25	G1
YR270032LM	32	G1 1/4
YR270040LM	40	G1 1/2
YR270050LM	50	G2

■ Double/single acting



Temperature: -15 ÷ 230 °C
 Fluid: air, water, chemical agents, etc.
 Working pressure: Max 64 bar
 (based on working temperature)

Double acting			Single acting		
Part. No	Ø	DN	Part. No	Ø	DN
YR270008DA	8	G1/4	YR270008SR	8	G1/4
YR270010DA	10	G3/8	YR270010SR	10	G3/8
YR270015DA	15	G1/2	YR270015SR	15	G1/2
YR270020DA	20	G3/4	YR270020SR	20	G3/4
YR270025DA	25	G1	YR270025SR	25	G1
YR270032DA	32	G1 1/4	YR270032SR	32	G1 1/4
YR270040DA	40	G1 1/2	YR270040SR	40	G1 1/2
YR270050DA	50	G2	YR270050SR	50	G2

YR280 Brass L-shaped ball valve 3/2 with manual lever or rotary actuator

■ With manual lever



Part. No	Ø	DN
YR280008LM	8	G1/4
YR280010LM	10	G3/8
YR280015LM	15	G1/2
YR280020LM	20	G3/4
YR280025LM	25	G1
YR280032LM	32	G1 1/4
YR280040LM	40	G1 1/2
YR280050LM	50	G2

■ Double/single acting



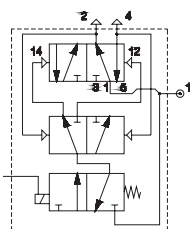
Temperature: -20 ÷ 160 °C
 Fluid: air, water, chemical agents, etc.
 Working pressure: DN 1/4" ÷ DN 3/4" PN30
 DN 1" PN16 - DN 1 1/4" ÷ DN 2" PN10

Double acting			Single acting		
Part. No	Ø	DN	Part. No	Ø	DN
YR280008DA	8	G1/4	YR280008SR	8	G1/4
YR280010DA	10	G3/8	YR280010SR	10	G3/8
YR280015DA	15	G1/2	YR280015SR	15	G1/2
YR280020DA	20	G3/4	YR280020SR	20	G3/4
YR280025DA	25	G1	YR280025SR	25	G1
YR280032DA	32	G1 1/4	YR280032SR	32	G1 1/4
YR280040DA	40	G1 1/2	YR280040SR	40	G1 1/2
YR280050DA	50	G2	YR280050SR	50	G2

Binary Counter (Flip Flop)

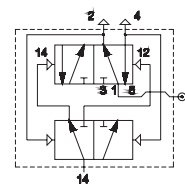
3

■ AP-500
Electrical override



Working pressure: 10 bar
Energizing pressure: 1,5 bar
Ambient temperature: -30 ÷ +80 °C
Coil: U1 - DA series

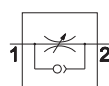
■ AP-520
Pneumatic override



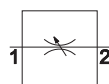
Solenoid valves are supplied without coil/connector/locking nut

Flow control valve - metallic body

■ AM-50
One-way and two-way flow control valve
M5 - G1/8 - G1/4 - G3/8 - G1/2



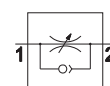
One-way regulation



Two-way regulation

		Ø mm
AM-5060	M5	1
AM-5061	G1/8	1
AM-5062	G1/8	2,25
AM-5063	G1/8	3,5
AM-5064	G1/4	5
AM-5065	G1/4	6
AM-5066	G3/8	6
AM-5067	G1/2	9
AM-5070	M5	1
AM-5071	G1/8	1
AM-5072	G1/8	2,25
AM-5074	G1/4	5
AM-5076	G3/8	6
AM-5077	G1/2	9

■ AM-50
One-way flow control valve G1/2 - G3/4 - G1

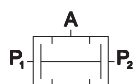


One-way regulation

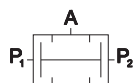
		Ø mm
AM-5090	G1/2	9
AM-5091	G3/4	9
AM-5092	G1	12

Signal processing valve

■ AM-51
Two-pressure valve "AND"

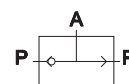


AM-5160
threaded body G1/8

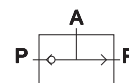


AM-5161
push-in fittings Ø4x2

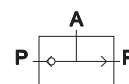
■ AM-51
Selector valve "OR"



AM-5162
threaded body G1/8




AM-5163
push-in fittings Ø4x2



AM-5164
threaded body G1/4

Gradual starter

AM-52
Gradual starter G1/8 ÷ G1




With manual regulation

Model	Thread	Ø mm
AM-5240	G1/8	6,5
AM-5241	G1/4	6,5
AM-5242	G1/4	9,5
AM-5243	G3/8	9,5

With electrical switch

Model	Thread	Ø mm
AM-5242E	G1/8	9,5
AM-5243E	G3/8	9,5



With manual regulation


Model	Thread	Ø mm
AM-5254	G1/2	15
AM-5255	G3/4	15
AM-5256	G1	24

With electrical switch

Model	Thread	Ø mm
AM-5259	G1/2	15
AM-5260	G3/4	15
AM-5261	G1	24

Economizer


AM-53
Economizer G1/8 ÷ G1



Model	Thread	Ø mm
AM-5350	G1/8	6,5
AM-5351	G1/4	6,5
AM-5352	G1/4	9,5
AM-5353	G3/8	9,5
AM-5354	G1/2	15
AM-5355	G3/4	15
AM-5356	G1	24

Check valve


AM-54
Check valve G1/2 - G3/4 - G1



Model	Thread	Ø mm
AM-5400	G1/2	15
AM-5401	G3/4	15
AM-5402	G1	24


Blocking valve

AM-55
Blocking valve



One-way

Model	Thread	Ø mm
AM-5500	G1/8	6,5
AM-5501	G1/4	6,5
AM-5502	G1/4	9,5
AM-5503	G3/8	9,5
AM-5504	G1/2	15




Two-way

Model	Thread	Ø mm
AM-5510	G1/8	6,5
AM-5511	G1/4	6,5
AM-5512	G1/4	9,5
AM-5513	G3/8	9,5
AM-5514	G1/2	15


Transducer and pressure switch

AM-5200
Pneumo-electrical transducer



AM-5200

AM-5220
Adjustable pressure switch



AM-5220

Digital pressure switch

■ HZ9N ...



Working temperature: 0 ÷ 60 °C
Voltage: 12 - 24 V DC
Repeatability: ≤ ± 2% F.S. ± 1 digit
Analog output: 1 ÷ 5 V 4 - 20 mA (upon request)
Connection: connector M8 and cable (upon request)

Part No.	Working pressure (bar)	Output	Min. adjustable unit (bar)	Cable length (m)	Thread
HZ9NC04	-1 +1	2xPNP	0,001	2 m	G1/8 - M5
HZ9NC02	-1 +1	2xNPN	0,001	2 m	G1/8 - M5
HZ9NP04	0 -10	2xPNP	0,01	2 m	G1/8 - M5
HZ9NP02	0 -10	2xNPN	0,01	2 m	G1/8 - M5

HZ9N1F



Adaptor for panel mounting + protection cover

HZ9N2F



Supports - 2 pcs

HZ9NM08-0200



M8 Extensions
2 m Cable

Adjustable diaphragm pressure switch

■ HZ9N12



Max pressure: 80 bar
Max temperature: -10 ÷ 120 °C
Max voltage: 250 V AC
Max current: 0,5 A
Body: brass

Version with NC - NC/NO contact upon request

Part No.	Adjustable range (bar)	Tolerance 20° C (bar)	Contact	Thread
HZ9N12110060	1 - 10	± 0,5	NO	R1/8
HZ9N12110080	1 - 10	± 0,5	NO	R1/4
HZ9N12111060	0,1 - 1	± 0,1	NO	R1/8
HZ9N12111080	0,1 - 1	± 0,1	NO	R1/4

ATEX



ATEX version available
For further information please contact our Sales Office

HZ9N12A



Protection cap
IP54

HZ9N12B



Protection connector
IP65

HZ9N12C



Protection connector
IP65 DIN

CHARACTERISTICS

Ambient temperature	-20 ÷ +50 °C
Fluid temperature	-10 ÷ +95 °C
Fluid	water, air, non-corrosive gases
Valve body	brass
Seals	NBR
Coil	U1
	U2
Power consumption	see coil section
Voltage	24 V DC, 24 V AC, 110 V AC, 220 V AC 50/60 Hz

Other versions available upon request

- VITON, EPDM seals; EPM seals for food industry
- Nickel-plated brass or AISI 316 stainless steel body
- NO version
- G1 1/4 - G1 1/2 - G2


2 ways NC direct action


Part No.	Connections	Nom. bore (mm)	Pressure (bar)				Coil	KV (l/min)
			Nominal	Min	Max AC	Max DC		
YF210061D (a)	G1/8	2	25	0	12	10	U1	1,5
YF210062D (b)	G1/8	2	25	0	22	20	U2	1,7
YF210082D (b)	G1/4	3,5	100	0	10	8	U2	5,4

2 ways NC servo-assisted diaphragm


Part No.	Connections	Nom. bore (mm)	Pressure (bar)				Coil	KV (l/min)
			Nominal	Min	Max AC	Max DC		
YF210151S	G1/2	12,7	25	0,15	18	16	U1	40
YF210201S	G3/4	19	25	0,15	16	13	U1	90
YF210251S	G1	25	25	0,15	12	10	U1	176

3 ways NC direct action


Part No.	Connections	Nom. bore (mm)	Pressure (bar)				Coil	KV (l/min)
			Nominal	Min	Max AC	Max DC		
YF310061D (c)	G1/8	1,5	10	0	10	10	U1	1
YF310082D (d)	G1/4	2,4	10	0	10	10	U2	2,3

Coils

U1

YFDA-0224	24 V AC - 50/60 Hz - 8 VA
YFDA-0211	110 V AC - 50/60 Hz - 8 VA
YFDA-0223	230 V AC - 50/60 Hz - 8 VA
DA-0102	24 V DC - 6 W


U2

YFDB-0224	24 V AC - 50/60 Hz - 13 VA
YFDB-0211	110 V AC - 50/60 Hz - 13 VA
YFDB-0223	230 V AC - 50/60 Hz - 13 VA
DB-0502	24 V DC - 11 W

Solenoid valves are supplied with locking nut, without coil and connector

CHARACTERISTICS

Ambient temperature	-20 ÷ +50 °C
Fluid	50 µm filtered air, with or without lubrication
Pressure	1,5 ÷ 9 bar
Connections	G1/4
Pace regulators	embodied
Function	it allows cylinders to stop with highly precise position repeatability
Solenoid Valves	GL series
Commutation system	spool
Electropilot/Coil	A series/U05 series
Voltage	24 V DC - 12 V DC - 24 V AC - 110 V AC - 230 V AC (only version with external electrical connection)
Power consumption	U05 = 2 W (DC) 2,3 VA (AC)
Manual override	recessed button - 1 position

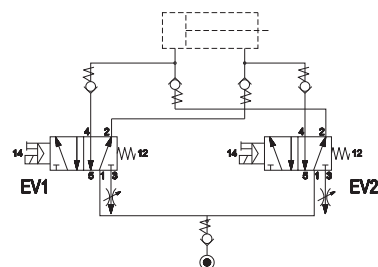


3

■ Embodied pace regulators



For further information please contact our Sales Office

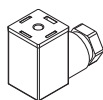


DD- ...

AM-5109



- DD-040 24 V AC
- DD-041 12 V DC
- DD-051 24 V DC
- DD-060 110 V AC
- DD-070 230 V AC

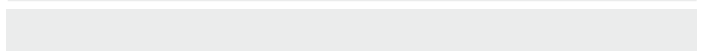


15 mm U05 Coil - Faston

15 mm Connectors

4

Air Treatment



Air Treatment Units

HZE

3



Pressure Gauges

HZ9

10



Regulators and
Transducers

HZRP
HZRE

11
11



Microregulators

HZRM

12



MODULAR

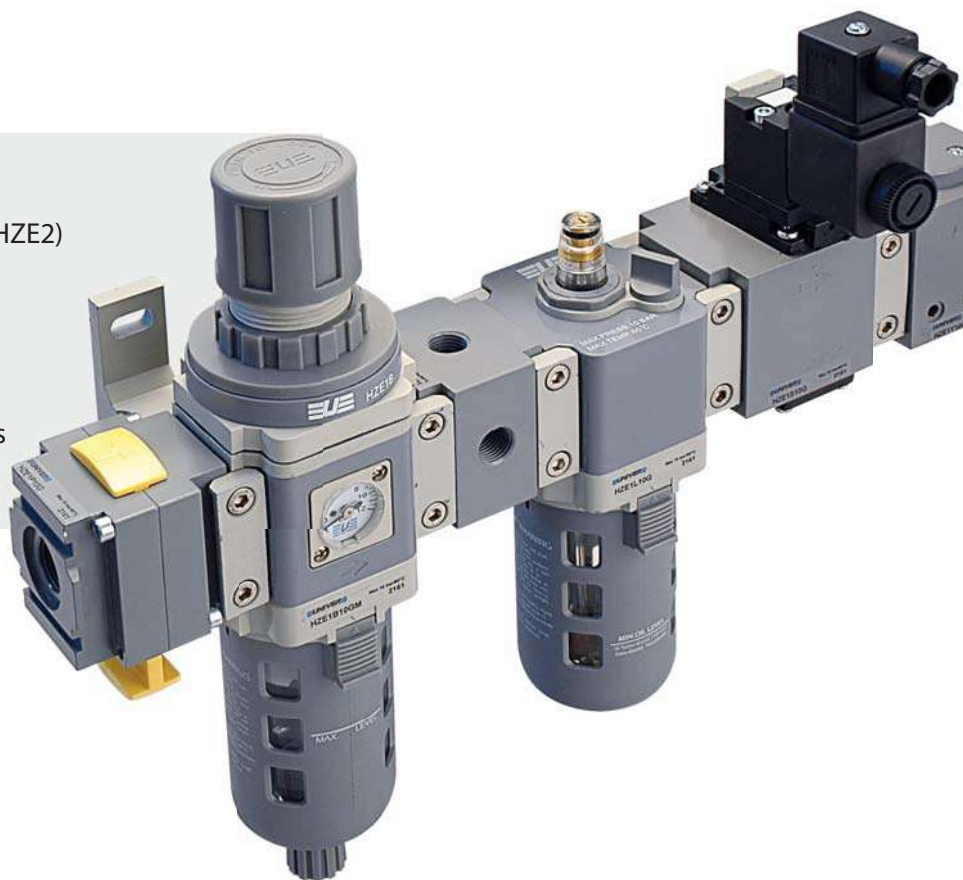
40 mm (HZE0) 63 mm (HZE1) 80 mm (HZE2)

INTEGRATED GAUGE

Standard supplied

COMPLETE SOLUTION

Possibility of assembling combinations complete with accessories



G1/4

Size 0



FR+L

600
NI/min

G3/8 - G1/2

Size 1



FR+L

2800
NI/min

G1/2

Size 2



FR+L

4300
NI/min



HZE-Y

Gradual starter



HZE-N

Diverter block



HZE-P

Lockable valve



HZE-S

Shut-off valve



HZE-RL

Lockable regulator

CHARACTERISTICS

Ambient temperature	0 ÷ +60 °C
Fluid	filtered air, with or without lubrication
Working pressure	10 bar
Max pressure	15 bar
Size	0 - 1 - 2
Body	tecnopolymer with metal threaded elements (size 0) die-cast aluminium (size 1 - 2)
Knob	tecnopolymer
Ring nut	tecnopolymer
Bowl	polycarbonate
Bowl guard	tecnopolymer (size 1-2)
Filter element	polyethylene
Seals	NBR
Springs	steel
Diaphragm	fabric reinforced rubber



For round gauge mounting (HZ9P):

Size 0 = Replace HZ9464G gauge with HZE7Z480 square adaptor G1/8, to be ordered separately

Size 1-2 = Replace HZ9464G gauge with HZE7Z480 square adaptor G1/8 placed on the rear side of the regulator or filter regulator

CODIFICATION KEY

H	Z	E	0	B	0	8	G		M
1	2	3	4	5	6				

1 Series	2 Size	3 Model
HZE = Air treatment units with standard manual drain	0 = Small (G1/4) 1 = Medium (G3/8 - G1/2) 2 = Large (G1/2)	F = Filter R = Regulator L = Lubricator B = Filter regulator D = Filter regulator+Lubricator (FR+L) C = Filter+Regulator+Lubricator (F+R+L)

4 Thread	5 Option	6 Pressure gauge
08G = G1/4 (size 0) 10G = G3/8(size 1) 15G = G1/2 (size 1-2) 20G = G3/4 (size 2) * 25G = G1 (size 2) *	A = Automatic drain (except for size 0) S = Semi-automatic drain	M = Integrated square pressure gauge (standard supplied) Square adaptor G1/8 upon request

* = with threaded ends

Filter


Size	0	1		2
Part No.	HZE0F08G	HZE1F10G	HZE1F15G	HZE2F15G
Connections	G1/4	G3/8	G1/2	G1/2
Filtration rate (µm)	5	5		5
Nominal flow rate (NI/min) ^(A)	1100	3500		6500
Max inlet pressure (bar-MPa-psi)	10 - 1 - 145	10 - 1 - 145		10 - 1 - 145
Condensation drain capacity (cm ³)	12	45		80
Condensation drain	manual	manual		manual

(A) = Inlet pressure 7 bar, Δp 0,5 bar

Regulator

Size	0	1		2
Part No.	HZE0R08GM	HZE1R10GM	HZE1R15GM	HZE2R15GM
Connections	G1/4	G3/8	G1/2	G1/2
Nominal flow rate (NI/min) ^(A)	1000	2100		4300
Max inlet pressure (bar-MPa-psi)	10 - 1 - 145	10 - 1 - 145		10 - 1 - 145
Pressure adjustment-relieving version (bar)	0,5 ÷ 8,5	0,5 ÷ 8,5		0,5 ÷ 8,5
Pressure gauge (standard supplied)	HZ9464G	HZ9464G		HZ9464G
Pressure gauge adaptor	G1/8 ^(B)	G1/8 ^(C)		G1/8 ^(C)

(A) = Inlet pressure 7 bar, outlet pressure 5 bar - Δp 1 bar
 (B) = Upon request (replace HZ9464G gauge with HZE7Z480 square adaptor G1/8, to be ordered separately)
 (C) = Standard supplied (replace HZ9464G gauge with HZE7Z480 square adaptor G1/8 placed on the rear side)

Other available versions

■ Without manometer size 0



Size	Part No.
0	HZE0R08G

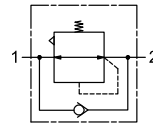
■ Lockable knob size 1-2



Size	Part No.
1	HZE1RL10GM - HZE1RL15GM
2	HZE2RL15GM

■ Check valve size 0-1-2

The check valve inside the regulator allows to relieve downstream pressure in a quick and effective way.



Size	Part No.
0	HZE0R08GMV
1	HZE1R10GMV-HZE1R15GMV
2	HZE2R15GMV

Lubricator

Size	0	1		2
Part No.	HZE0L08G	HZE1L10G	HZE1L15G	HZE2L15G
Connections	G1/4	G3/8	G1/2	G1/2
Nominal flow rate (NI/min) ^(A)	1400	4400		7000
Max inlet pressure (bar-MPa-psi)	10 - 1 - 145	10 - 1 - 145		10 - 1 - 145
Bowl capacity (cm³)	20	85		170
Recommended oil	ISO VG 32	ISO VG 32		ISO VG 32
Min. working flow rate (NI/min)	25	30		65

(A) = Inlet pressure 7 bar - Δp 0,5 bar

Filter regulator



Size	0	1		2
Part No.	HZE0B08GM	HZE1B10GM	HZE1B15GM	HZE2B15GM
Connections	G1/4	G3/8	G1/2	G1/2
Filtration rate (µm)	5	5		5
Nominal flow rate (NI/min) ^(A)	600	2300		4500
Max inlet pressure (bar-MPa-psi)	10 - 1 - 145	10 - 1 - 145		10 - 1 - 145
Pressure adjustment - relieving version (bar)	0,5 ÷ 8,5	0,5 ÷ 8,5		0,5 ÷ 8,5
Pressure gauge (standard supplied)	HZ9464G	HZ9464G		HZ9464G
Pressure gauge adaptor	G1/8 ^(B)	G1/8 ^(C)		G1/8 ^(C)
Condensation drain capacity (cm ³)	12	45		80
Condensation drain	manual	manual		manual

(A) = Inlet pressure 7 bar, outlet pressure 5 bar - Δp 1 bar

(B) = Upon request (replace HZ9464G gauge with HZE7Z480 square adaptor G1/8, to be ordered separately)

(C) = Standard supplied (replace HZ9464G gauge with HZE7Z480 square adaptor G1/8 placed on the rear side)

Other available versions

■ Check valve size 0-1-2

The check valve inside the filter regulator allows to relieve downstream pressure in a quick and effective way.



Size	Part No.
0	HZE0B08GMV
1	HZE1B10GMV-HZE1B15GMV
2	HZE2B15GMV

Filter regulator + Lubricator



Size	0	1		2
Part No.	HZE0D08GM	HZE1D10GM	HZE1D15GM	HZE2D15GM
Connections	G1/4	G3/8	G1/2	G1/2
Filtration rate (µm)	5	5		5
Nominal flow rate (NI/min) ^(A)	600	2800		4300
Max inlet pressure (bar-MPa-psi)	10 - 1 - 145	10 - 1 - 145		10 - 1 - 145
Fluid	compressed air	compressed air		compressed air
Pressure adjustment - relieving version (bar)	0,5 ÷ 8,5	0,5 ÷ 8,5		0,5 ÷ 8,5
Pressure gauge (standard supplied)	HZ9464G	HZ9464G		HZ9464G
Pressure gauge adaptor	G1/8 ^(B)	G1/8 ^(C)		G1/8 ^(C)
Condensation drain capacity (cm ³)	12	45		80
Condensation drain	manual	manual		manual
Recommended oil	ISO VG 32	ISO VG 32		ISO VG 32
Min. working flow rate (NI/min)	25	30		65

(A) = Inlet pressure 7 bar, outlet pressure 5 bar - Δp 1 bar

(B) = Upon request (replace HZ9464G gauge with HZE7Z480 square adaptor G1/8, to be ordered separately)

(C) = Standard supplied (replace HZ9464G gauge with HZE7Z480 square adaptor G1/8 placed on the rear side)

Filter + Regulator + Lubricator



Size	0	1		2
Part No.	HZE0C08GM	HZE1C10GM	HZE1C15GM	HZE2C15GM
Connections	G1/4	G3/8	G1/2	G1/2
Filtration rate (µm)	5	5		5
Nominal flow rate (NI/min) ^(A)	550	1700		2500
Max inlet pressure (bar-MPa-psi)	10 - 1 - 145	10 - 1 - 145		10 - 1 - 145
Fluid	compressed air	compressed air		compressed air
Pressure adjustment - relieving version (bar)	0,5 ÷ 8,5	0,5 ÷ 8,5		0,5 ÷ 8,5
Pressure gauge (standard supplied)	HZ9464G	HZ9464G		HZ9464G
Pressure gauge adaptor	G1/8 ^(B)	G1/8 ^(C)		G1/8 ^(C)
Condensation drain capacity (cm ³)	12	45		80
Condensation drain	manual	manual		manual
Recommended oil	ISO VG 32	ISO VG 32		ISO VG 32
Min. working flow rate (NI/min)	25	30		65

(A) = Inlet pressure 7 bar, outlet pressure 5 bar - Δp 1 bar

(B) = Upon request (replace HZ9464G gauge with HZE7Z480 square adaptor G1/8, to be ordered separately)

(C) = Standard supplied (replace HZ9464G gauge with HZE7Z480 square adaptor G1/8 placed on the rear side)

Gradual Starter

	Size Part No. Connections Nominal flow rate (NI/min) ^(A) Max inlet pressure (bar-MPa-psi) Min. pressure (bar) Fluid	0 HZE0Y08G G1/4 900 10 - 1 - 145 2 compressed air	1 HZE1Y10G G3/8 2200 10 - 1 - 145 3,5 compressed air

(A) = Inlet pressure 7 bar, outlet pressure 5 bar - Δp 1 bar

Diverter Block

	Size Part No. Connections Max inlet pressure (bar-MPa-psi) Fluid	0 HZE0N08G In/Out G1/4 Auxiliary G1/8 10 - 1 - 145 compressed air	1 HZE1N10G In/Out G3/8 Auxiliary G1/4 10 - 1 - 145 compressed air

Use blanking plugs to close unused ways (not included)

Lockable Valve

	Size Part No. Connections Nominal flow rate (NI/min) ^(A) Max inlet pressure (bar-MPa-psi) Fluid	0 HZE0P08G G1/4 900 10 - 1 - 145 compressed air	1 HZE1P10G G3/8 5000 10 - 1 - 145 compressed air

(A) = Inlet pressure 7 bar, outlet pressure 5 bar - Δp 1 bar

Shut-off valve

	Size Part No. Connections Nominal flow rate (NI/min) ^(A) Max inlet pressure (bar-MPa-psi) Min. pressure (bar-MPa-psi) Fluid Commutation system Ways/Positions Control Nominal diameter (mm) Electropilot Coil Manual Override	0 HZE0S08G G1/4 900 10 - 1 - 145 2 - 0,16 - 23 compressed air poppet 3/2 NC indirect electropneumatic 8 U1 AA series DA/DC two-position screw	1 HZE1S10G G3/8 2800 10 - 1 - 145 2 - 0,2 - 29 compressed air poppet 3/2 NC indirect electropneumatic 10 U1 AA series DA/DC two-position screw

(A) = Inlet pressure 7 bar, outlet pressure 5 bar - Δp 1 bar

Coils

	<p>■ U1</p> <p>DA-0050 12 V DC DA-0051 24 V DC DA-0106 24 V AC/50-60 Hz DA-0108 110 V AC/50-60 Hz DA-0124 230 V AC/50-60 Hz</p>		<p>■ U3</p> <p>DC-0301 12 V DC DC-0302 24 V DC DC-0307 24 V AC/50-60 Hz DC-0309 110 V AC/50-60 Hz DC-0310 230 V AC/50-60 Hz</p>
--	---	--	---

Other available versions

<p>■ Size 0 U05</p>	<p>■ Size 1 U05</p>	<p>■ Size 1 U3 CNOMO</p>
---------------------	---------------------	--------------------------

Solenoid valves are supplied with locking nut, without coil

HZE0/1Z200	HZE0/1/2Z210	HZE0/1/2Z300	HZE0/1/2Z310	HZE7Z480/90	HZE2Z500/501
Assembly kit Size 0 HZE0Z200 Size 1-2 HZE1Z200	T-bracket assembly kit Size 0 HZE0Z210 Size 1 HZE1Z210 Size 2 HZE2Z210	C-bracket Size 0 HZE0Z300 Size 1 HZE1Z300 Size 2 HZE2Z300	Regulator L-bracket Size 0 HZE0Z310 Size 1 HZE1Z310 Size 2 HZE2Z310	Threaded adaptor for pressure gauge Size 0-1-2 G1/8 HZE7Z480 G1/4 HZE7Z490 Screw torque: Max 0,6 Nm	Threaded ends Size 2 G3/4 HZE2Z500 G1 HZE2Z501

Filter and filter regulator accessories

HZE0/1/2Z600	HZE0/1/2Z600SS	HZE7Z400	HZE0/1Z401	HZE0/1Z402
Standard bowl with manual drain Size 0 HZE0Z600 Size 1 HZE1Z600 Size 2 HZE2Z600	Bowl with semi-automatic drain Size 0 HZE0Z600SS Size 1 HZE1Z600SS Size 2 HZE2Z600SS	Automatic drain Size 1-2 HZE7Z400	Semi-automatic drain Size 0 HZE0Z401 Size 1-2 HZE1Z401	Manual drain Size 0 HZE0Z402 Size 1-2 HZE1Z402

HZE0/1/2Z660	HZE1/2Z670
Filter elements 5 µm Size 0 HZE0Z660 Size 1 HZE1Z660 Size 2 HZE2Z660	Coalescing filter 0,3 µm Size 1 HZE1Z670 Size 2 HZE2Z670

Other filter elements upon request

Regulator and filter regulator accessories

HZE0/1/2Z602	HZE1/2Z652/4/8	HZE0/1/2Z603	HZE0/1/2Z610/1
Knob Size 0 HZE0Z602 Size 1 HZE1Z602 Size 2 HZE2Z602	Regulator spring Size 1 Pressure adjustment HZE1Z652 0,5 ÷ 1,7 HZE1Z654 0,5 ÷ 3,5 HZE1Z658 0,5 ÷ 8,5 Size 2 HZE2Z652 0,5 ÷ 1,7 HZE2Z654 0,5 ÷ 3,5 HZE2Z658 0,5 ÷ 8,5	Ring nut for panel Size 0 HZE0Z603 Size 1 HZE1Z603 Size 2 HZE2Z603	Diaphragm kit Size 0 HZE0Z610 relieving HZE0Z611 non-relieving Size 1 HZE1Z610 relieving HZE1Z611 non-relieving Size 2 HZE2Z610 relieving HZE2Z611 non-relieving

Lubricator accessories

HZE0/1/2Z601	HZE7Z470
Standard bowl Size 0 HZE0Z601 Size 1 HZE1Z601 Size 2 HZE2Z601	Lubricator transparent dome Size 0-1-2 HZE7Z470

Pressure gauge

■ HZ9P



Thread: brass, copper alloy
Body: technopolymer
Movement: brass
Indicator: aluminium, black painted
Dial: acrylic pressure mounted
Accuracy: EN 837 class 1,6 - 2,5. ASME B40.1 grade B
Protection: IP 43

Part No.	Ø	Scale		Thread
		Bar	MPa	
HZ9P400318	40	0 - 2,5	0 - 0,25	R1/8
HZ9P400618	40	0 - 6	0 - 0,6	R1/8
HZ9P401018	40	0 - 10	0 - 1	R1/8
HZ9P500314	50	0 - 2,5	0 - 0,25	R1/4
HZ9P500614	50	0 - 6	0 - 0,6	R1/4
HZ9P501014	50	0 - 10	0 - 1	R1/4
HZ9P630314	63	0 - 2,5	0 - 0,25	R1/4
HZ9P630614	63	0 - 6	0 - 0,6	R1/4
HZ9P631014	63	0 - 10	0 - 1	R1/4

Pressure gauge with flange for panel mounting

■ HZ9PB



Thread: brass, copper alloy
Body: metal, black painted
Assembly: chromium plated front flange with 3 holes
Movement: brass
Indicator: aluminium, black painted
Dial: acrylic
Accuracy: EN 837 class 1,6 - 2,5. ASME B40.1 grade B
Protection: IP 43

Part No.	Ø	Scale		Thread
		Bar	MPa	
HZ9PB400318	40	0 - 2,5	0 - 0,25	R1/8
HZ9PB400618	40	0 - 6	0 - 0,6	R1/8
HZ9PB401018	40	0 - 10	0 - 1	R1/8
HZ9PB500314	50	0 - 2,5	0 - 0,25	R1/4
HZ9PB500614	50	0 - 6	0 - 0,6	R1/4
HZ9PB501014	50	0 - 10	0 - 1	R1/4
HZ9PB630314	63	0 - 2,5	0 - 0,25	R1/4
HZ9PB630614	63	0 - 6	0 - 0,6	R1/4
HZ9PB631014	63	0 - 10	0 - 1	R1/4

Pressure gauge with bracket for panel mounting

■ HZ9PBS



Thread: brass, copper alloy
Body: metal, black painted
Assembly: border with rear bracket
Movement: brass
Indicator: aluminium, black painted
Dial: acrylic
Accuracy: EN 837 class 1,6 - 2,5. ASME B40.1 grade B
Protection: IP 43

Part No.	Ø	Scale		Thread
		Bar	MPa	
HZ9PBS400318	40	0 - 2,5	0 - 0,25	R1/8
HZ9PBS400618	40	0 - 6	0 - 0,6	R1/8
HZ9PBS401018	40	0 - 10	0 - 1	R1/8
HZ9PBS500314	50	0 - 2,5	0 - 0,25	R1/4
HZ9PBS500614	50	0 - 6	0 - 0,6	R1/4
HZ9PBS501014	50	0 - 10	0 - 1	R1/4
HZ9PBS630314	63	0 - 2,5	0 - 0,25	R1/4
HZ9PBS630614	63	0 - 6	0 - 0,6	R1/4
HZ9PBS631014	63	0 - 10	0 - 1	R1/4

Recessed pressure gauge

■ HZ9464G



Body: tecnopolymer
Assembly: HZE series regulator and filter regulator size 0-1-2
Scale: 0 ÷ 12 bar
Dial: polycarbonate
Accuracy: ± 3% full scale

Precision regulators

■ HZRP10



Adjusting range
 HZRP1008GA 0,1 ÷ 3 bar
 HZRP1008GB 0,1 ÷ 4 bar
 HZRP1008GC 0,1 ÷ 8 bar

HZRP12: version with oversized exhaust

■ HZRP20



Adjusting range
 HZRP2008GA 0 ÷ 0,1 bar
 HZRP2008GB 0 ÷ 1 bar
 HZRP2008GC 0 ÷ 2 bar
 HZRP2008GD 0 ÷ 4 bar
 HZRP2008GE 0 ÷ 10 bar

Part No.	HZRP10	HZRP20
Fluid	filtered compressed air, not lubricated	
Connections	G1/4	
Max pressure	10 bar	17 bar
Ambient temperature	-17 ÷ +55 °C	-40 ÷ +70 °C
Nominal flow rate	420 NI/min ^(B)	1600 NI/min ^(B)
Consumption	3 NI/min	30 ÷ 375 NI/min (based on outlet pressure)
Exhaust capacity	HZRP10 = 90 NI/min HZRP12 = 330 NI/min	
Pressure variation	less than 0,4 mbar ^(A)	
Sensitivity	0,3 mbar	0,3 mbar
Body	zamak	die-cast aluminium
Diaphragms	NBR	NBR
Capsule and adjusting screw	stainless steel	stainless steel, brass
Knob	technopolymer	technopolymer

(A) = HZRP10 With supply pressure variation 2 bar
 (A) = HZRP20 With supply pressure variation 7 bar
 (B) = HZRP10 Inlet pressure 7 bar, outlet pressure 1,4 bar
 (B) = HZRP20 Inlet pressure 7 bar, outlet pressure 5 bar, Δp 1 bar

HZRP1310	HZRP2310	HZ9P...
Fixing bracket for HZRP10	Fixing bracket for HZRP20	Gauges Ø50 - R1/4 HZ9P500314 0 - 2,5 bar HZ9P500614 0 - 6 bar HZ9P501014 0 - 10 bar

Electro-pneumatic transducers



■ HZRE10

Adjusting range
 0,2 ÷ 1 bar
 0,14 ÷ 4 bar
 0,2 ÷ 8 bar

■ HZRE20

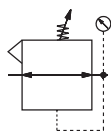
Adjusting range
 0,2 ÷ 1 bar
 0,14 ÷ 4 bar
 0,14 ÷ 7 bar

Part No.	HZRE10	HZRE20
Fluid	filtered compressed air, not lubricated	
Connections	G1/4	
Max pressure	7 ÷ 10 bar	7 ÷ 9 bar
Temperature	-30 ÷ +65 °C	-40 ÷ +70 °C
Flow rate	350 ÷ 600 NI/min	
Control Signal	0-10 V / 4-20 mA	
Voltage	-	7-30 V DC
Control System	Piezoelectric open ring	Piezoelectric closed ring
Hysteresis	< 0,5% F.S.	± 0,10% F.S.
Repeatability	< 0,5% F.S.	± 0,10% F.S.

Values of pressure and flow rate vary according to the model of transducer.

For further information please contact our Sales Office

Microregulators for air



Part No.	HZRM08G
Ambient temperature	-10 ÷ 50 °C
Max working pressure	20 bar
Fluid-relieving version	filtered air, with or without lubrication, neutral gases
Pressure adjustment ^(A)	0,8 ÷ 8 bar
Connections	G1/4
Pressure gauge connections	G1/8
Nominal flow rate ^(B)	320 NI/min
Body	alluminium
Knob	technopolymer
Bonnet	technopolymer
Spring	steel C85
Diaphragm	nitrile rubber (NBR)

(A) = Different adjustment range upon request

(B) = Nitrogen flow rate inlet pressure 15 bar, outlet pressure 5 bar, Δp 1 bar

Ring nut for panel mounting not included

HZRM603
HZRM310
HZRM652/4/8
HZRM610/1
AZ-0200


Ring nut for panel
HZRM603 Technopolymer

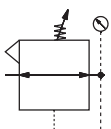
Regulator L-bracket
HZRM310 Nickel-plated steel

Regulator spring
Pressure adjustment:
HZRM652 0,2÷1,5 bar
HZRM654 0,3÷3 bar
HZRM658 1,5÷15 bar

Diaphragm kit
HZRM610 relieving
HZRM611 non-relieving

Grub screw G1/8
AZ-0200

Microregulators for air and water



	Brass	Stainless steel
Part No.	Upon request	
Ambient temperature	-10 ÷ 50 °C	-20 ÷ 80 °C
Max working pressure	20 bar	30 bar
Fluid relieving version	filtered air, with or without lubrication, neutral gases	
non-relieving version	water and compatible fluids	
Pressure adjustment ^(A)	0,8 ÷ 8 bar	
Connections	G1/4	
Pressure gauge connections	G1/8	
Nominal flow rate ^(B)	320 NI/min	
Body	brass	stainless steel AISI 316
Knob	technopolymer	-
Bonnet	technopolymer	stainless steel AISI 316
Bonnet upon request	brass	technopolymer
Spring	steel C85	stainless steel AISI 302
Diaphragm	NBR	stainless steel AISI 316

(A) = Different adjustment range upon request

(B) = Nitrogen flow rate Inlet pressure 15 bar, outlet pressure 5 bar, Δp 1 bar

Ring nut for panel mounting not included

HZRM603/603A
HZRM310/310A










Ring nut for panel
HZRM603 Technopolymer
HZRM603A Stainless steel AISI 316L

Regulator L-bracket
HZRM310 Nickel-plated steel
HZRM310A Stainless steel AISI 316L

5

Accessories















	Push-in Fittings	HA HAR HB	2 5 6
	Fittings with pneumatic functions	HC	9
	Standard Fittings	HD	13
	Push-on Fittings	HGC	16
	Olive Fittings	HGO	18
	Quick Couplings	HGU	19
	Tubes	HE/HF	20
	Magnetic and Electronic Sensors	DF DH/KM DF-R/DF-T	21 22 22

CHARACTERISTICS

Temperature	-20 ÷ 80 °C (based on the type of tube)
Fluid	compressed air, vacuum
Max pressure	15 bar
Working pressure	-0,99 ÷ 10 bar
Body	technopolymer
Fixing elements	nickel-plated brass with O-ring in NBR for parallel thread version (standard) teflon coating for taper thread version (upon request)
Clamp	stainless steel
Release ring	technopolymer
Application fields	pneumatic circuits
Recommended hoses	polyamide PA 10.12, polyurethane Sh.A98, co-polyurethane Sh.55D

5

<p>HA02 Smooth body straight parallel male</p>  <table border="1"> <thead> <tr> <th>Ø</th> <th>connection</th> </tr> </thead> <tbody> <tr><td>HA0204M5</td><td>4 M5</td></tr> <tr><td>HA0206M5</td><td>6 M5</td></tr> <tr><td>HA020418</td><td>4 G1/8</td></tr> <tr><td>HA020618</td><td>6 G1/8</td></tr> <tr><td>HA020818</td><td>8 G1/8</td></tr> <tr><td>HA020414</td><td>4 G1/4</td></tr> <tr><td>HA020614</td><td>6 G1/4</td></tr> <tr><td>HA020814</td><td>8 G1/4</td></tr> <tr><td>HA021014</td><td>10 G1/4</td></tr> <tr><td>HA020838</td><td>8 G3/8</td></tr> <tr><td>HA021038</td><td>10 G3/8</td></tr> <tr><td>HA021238</td><td>12 G3/8</td></tr> <tr><td>HA021012</td><td>10 G1/2</td></tr> <tr><td>HA021212</td><td>12 G1/2</td></tr> </tbody> </table>	Ø	connection	HA0204M5	4 M5	HA0206M5	6 M5	HA020418	4 G1/8	HA020618	6 G1/8	HA020818	8 G1/8	HA020414	4 G1/4	HA020614	6 G1/4	HA020814	8 G1/4	HA021014	10 G1/4	HA020838	8 G3/8	HA021038	10 G3/8	HA021238	12 G3/8	HA021012	10 G1/2	HA021212	12 G1/2	<p>HA04 Straight parallel male</p>  <table border="1"> <thead> <tr> <th>Ø</th> <th>connection</th> </tr> </thead> <tbody> <tr><td>HA0404M5</td><td>4 M5</td></tr> <tr><td>HA0406M5</td><td>6 M5</td></tr> <tr><td>HA040418</td><td>4 G1/8</td></tr> <tr><td>HA040618</td><td>6 G1/8</td></tr> <tr><td>HA040818</td><td>8 G1/8</td></tr> <tr><td>HA040414</td><td>4 G1/4</td></tr> <tr><td>HA040614</td><td>6 G1/4</td></tr> <tr><td>HA040814</td><td>8 G1/4</td></tr> <tr><td>HA041014</td><td>10 G1/4</td></tr> <tr><td>HA040838</td><td>8 G3/8</td></tr> <tr><td>HA041038</td><td>10 G3/8</td></tr> <tr><td>HA041238</td><td>12 G3/8</td></tr> <tr><td>HA041012</td><td>10 G1/2</td></tr> <tr><td>HA041212</td><td>12 G1/2</td></tr> </tbody> </table>	Ø	connection	HA0404M5	4 M5	HA0406M5	6 M5	HA040418	4 G1/8	HA040618	6 G1/8	HA040818	8 G1/8	HA040414	4 G1/4	HA040614	6 G1/4	HA040814	8 G1/4	HA041014	10 G1/4	HA040838	8 G3/8	HA041038	10 G3/8	HA041238	12 G3/8	HA041012	10 G1/2	HA041212	12 G1/2	<p>HA06 Plastic straight parallel male</p>  <table border="1"> <thead> <tr> <th>Ø</th> <th>connection</th> </tr> </thead> <tbody> <tr><td>HA060618</td><td>6 G1/8</td></tr> <tr><td>HA060818</td><td>8 G1/8</td></tr> <tr><td>HA060614</td><td>6 G1/4</td></tr> <tr><td>HA060814</td><td>8 G1/4</td></tr> <tr><td>HA061014</td><td>10 G1/4</td></tr> <tr><td>HA060838</td><td>8 G3/8</td></tr> <tr><td>HA061038</td><td>10 G3/8</td></tr> <tr><td>HA061238</td><td>12 G3/8</td></tr> <tr><td>HA061012</td><td>10 G1/2</td></tr> <tr><td>HA061212</td><td>12 G1/2</td></tr> </tbody> </table>	Ø	connection	HA060618	6 G1/8	HA060818	8 G1/8	HA060614	6 G1/4	HA060814	8 G1/4	HA061014	10 G1/4	HA060838	8 G3/8	HA061038	10 G3/8	HA061238	12 G3/8	HA061012	10 G1/2	HA061212	12 G1/2										
Ø	connection																																																																																													
HA0204M5	4 M5																																																																																													
HA0206M5	6 M5																																																																																													
HA020418	4 G1/8																																																																																													
HA020618	6 G1/8																																																																																													
HA020818	8 G1/8																																																																																													
HA020414	4 G1/4																																																																																													
HA020614	6 G1/4																																																																																													
HA020814	8 G1/4																																																																																													
HA021014	10 G1/4																																																																																													
HA020838	8 G3/8																																																																																													
HA021038	10 G3/8																																																																																													
HA021238	12 G3/8																																																																																													
HA021012	10 G1/2																																																																																													
HA021212	12 G1/2																																																																																													
Ø	connection																																																																																													
HA0404M5	4 M5																																																																																													
HA0406M5	6 M5																																																																																													
HA040418	4 G1/8																																																																																													
HA040618	6 G1/8																																																																																													
HA040818	8 G1/8																																																																																													
HA040414	4 G1/4																																																																																													
HA040614	6 G1/4																																																																																													
HA040814	8 G1/4																																																																																													
HA041014	10 G1/4																																																																																													
HA040838	8 G3/8																																																																																													
HA041038	10 G3/8																																																																																													
HA041238	12 G3/8																																																																																													
HA041012	10 G1/2																																																																																													
HA041212	12 G1/2																																																																																													
Ø	connection																																																																																													
HA060618	6 G1/8																																																																																													
HA060818	8 G1/8																																																																																													
HA060614	6 G1/4																																																																																													
HA060814	8 G1/4																																																																																													
HA061014	10 G1/4																																																																																													
HA060838	8 G3/8																																																																																													
HA061038	10 G3/8																																																																																													
HA061238	12 G3/8																																																																																													
HA061012	10 G1/2																																																																																													
HA061212	12 G1/2																																																																																													
<p>HA07 Straight female</p>  <table border="1"> <thead> <tr> <th>Ø</th> <th>connection</th> </tr> </thead> <tbody> <tr><td>HA070418</td><td>4 G1/8</td></tr> <tr><td>HA070618</td><td>6 G1/8</td></tr> <tr><td>HA070818</td><td>8 G1/8</td></tr> <tr><td>HA070614</td><td>6 G1/4</td></tr> <tr><td>HA070814</td><td>8 G1/4</td></tr> <tr><td>HA071014</td><td>10 G1/4</td></tr> <tr><td>HA070838</td><td>8 G3/8</td></tr> <tr><td>HA071038</td><td>10 G3/8</td></tr> <tr><td>HA071238</td><td>12 G3/8</td></tr> <tr><td>HA071212</td><td>12 G1/2</td></tr> </tbody> </table>	Ø	connection	HA070418	4 G1/8	HA070618	6 G1/8	HA070818	8 G1/8	HA070614	6 G1/4	HA070814	8 G1/4	HA071014	10 G1/4	HA070838	8 G3/8	HA071038	10 G3/8	HA071238	12 G3/8	HA071212	12 G1/2	<p>HA08 Swivel elbow female</p>  <table border="1"> <thead> <tr> <th>Ø</th> <th>connection</th> </tr> </thead> <tbody> <tr><td>HA080418</td><td>4 G1/8</td></tr> <tr><td>HA080618</td><td>6 G1/8</td></tr> <tr><td>HA080818</td><td>8 G1/8</td></tr> <tr><td>HA080614</td><td>4 G1/4</td></tr> <tr><td>HA080814</td><td>8 G1/4</td></tr> <tr><td>HA081014</td><td>10 G1/4</td></tr> <tr><td>HA080838</td><td>8 G3/8</td></tr> <tr><td>HA081038</td><td>10 G3/8</td></tr> <tr><td>HA081238</td><td>12 G3/8</td></tr> <tr><td>HA081212</td><td>12 G1/2</td></tr> </tbody> </table>	Ø	connection	HA080418	4 G1/8	HA080618	6 G1/8	HA080818	8 G1/8	HA080614	4 G1/4	HA080814	8 G1/4	HA081014	10 G1/4	HA080838	8 G3/8	HA081038	10 G3/8	HA081238	12 G3/8	HA081212	12 G1/2	<p>HA10B Low elbow</p>  <p>NEW</p> <table border="1"> <thead> <tr> <th>Ø</th> <th>connection</th> </tr> </thead> <tbody> <tr><td>HA10B04M5</td><td>4 M5</td></tr> <tr><td>HA10B06M5</td><td>6 M5</td></tr> <tr><td>HA10B0418</td><td>4 G1/8</td></tr> <tr><td>HA10B0618</td><td>6 G1/8</td></tr> <tr><td>HA10B0818</td><td>8 G1/8</td></tr> <tr><td>HA10B0414</td><td>4 G1/4</td></tr> <tr><td>HA10B0614</td><td>6 G1/4</td></tr> <tr><td>HA10B0814</td><td>8 G1/4</td></tr> <tr><td>HA10B1014</td><td>10 G1/4</td></tr> <tr><td>HA10B0838</td><td>8 G3/8</td></tr> <tr><td>HA10B1038</td><td>10 G3/8</td></tr> <tr><td>HA10B1238</td><td>12 G3/8</td></tr> <tr><td>HA10B1012</td><td>10 G1/2</td></tr> <tr><td>HA10B1212</td><td>12 G1/2</td></tr> </tbody> </table>	Ø	connection	HA10B04M5	4 M5	HA10B06M5	6 M5	HA10B0418	4 G1/8	HA10B0618	6 G1/8	HA10B0818	8 G1/8	HA10B0414	4 G1/4	HA10B0614	6 G1/4	HA10B0814	8 G1/4	HA10B1014	10 G1/4	HA10B0838	8 G3/8	HA10B1038	10 G3/8	HA10B1238	12 G3/8	HA10B1012	10 G1/2	HA10B1212	12 G1/2																		
Ø	connection																																																																																													
HA070418	4 G1/8																																																																																													
HA070618	6 G1/8																																																																																													
HA070818	8 G1/8																																																																																													
HA070614	6 G1/4																																																																																													
HA070814	8 G1/4																																																																																													
HA071014	10 G1/4																																																																																													
HA070838	8 G3/8																																																																																													
HA071038	10 G3/8																																																																																													
HA071238	12 G3/8																																																																																													
HA071212	12 G1/2																																																																																													
Ø	connection																																																																																													
HA080418	4 G1/8																																																																																													
HA080618	6 G1/8																																																																																													
HA080818	8 G1/8																																																																																													
HA080614	4 G1/4																																																																																													
HA080814	8 G1/4																																																																																													
HA081014	10 G1/4																																																																																													
HA080838	8 G3/8																																																																																													
HA081038	10 G3/8																																																																																													
HA081238	12 G3/8																																																																																													
HA081212	12 G1/2																																																																																													
Ø	connection																																																																																													
HA10B04M5	4 M5																																																																																													
HA10B06M5	6 M5																																																																																													
HA10B0418	4 G1/8																																																																																													
HA10B0618	6 G1/8																																																																																													
HA10B0818	8 G1/8																																																																																													
HA10B0414	4 G1/4																																																																																													
HA10B0614	6 G1/4																																																																																													
HA10B0814	8 G1/4																																																																																													
HA10B1014	10 G1/4																																																																																													
HA10B0838	8 G3/8																																																																																													
HA10B1038	10 G3/8																																																																																													
HA10B1238	12 G3/8																																																																																													
HA10B1012	10 G1/2																																																																																													
HA10B1212	12 G1/2																																																																																													
<p>HA12 Extended swivel elbow parallel male</p>  <table border="1"> <thead> <tr> <th>Ø</th> <th>connection</th> </tr> </thead> <tbody> <tr><td>HA1204M5</td><td>4 M5</td></tr> <tr><td>HA1206M5</td><td>6 M5</td></tr> <tr><td>HA120418</td><td>4 G1/8</td></tr> <tr><td>HA120618</td><td>6 G1/8</td></tr> <tr><td>HA120818</td><td>8 G1/8</td></tr> <tr><td>HA120414</td><td>4 G1/4</td></tr> <tr><td>HA120614</td><td>6 G1/4</td></tr> <tr><td>HA120814</td><td>8 G1/4</td></tr> <tr><td>HA121014</td><td>10 G1/4</td></tr> <tr><td>HA120638</td><td>6 G3/8</td></tr> <tr><td>HA120838</td><td>8 G3/8</td></tr> <tr><td>HA121038</td><td>10 G3/8</td></tr> <tr><td>HA121238</td><td>12 G3/8</td></tr> <tr><td>HA121012</td><td>10 G1/2</td></tr> <tr><td>HA121212</td><td>12 G1/2</td></tr> </tbody> </table>	Ø	connection	HA1204M5	4 M5	HA1206M5	6 M5	HA120418	4 G1/8	HA120618	6 G1/8	HA120818	8 G1/8	HA120414	4 G1/4	HA120614	6 G1/4	HA120814	8 G1/4	HA121014	10 G1/4	HA120638	6 G3/8	HA120838	8 G3/8	HA121038	10 G3/8	HA121238	12 G3/8	HA121012	10 G1/2	HA121212	12 G1/2	<p>HA12B Extended swivel low elbow parallel male</p>  <p>NEW</p> <table border="1"> <thead> <tr> <th>Ø</th> <th>connection</th> </tr> </thead> <tbody> <tr><td>HA12B04M5</td><td>4 M5</td></tr> <tr><td>HA12B06M5</td><td>6 M5</td></tr> <tr><td>HA12B0418</td><td>4 G1/8</td></tr> <tr><td>HA12B0618</td><td>6 G1/8</td></tr> <tr><td>HA12B0818</td><td>8 G1/8</td></tr> <tr><td>HA12B0414</td><td>4 G1/4</td></tr> <tr><td>HA12B0614</td><td>6 G1/4</td></tr> <tr><td>HA12B0814</td><td>8 G1/4</td></tr> <tr><td>HA12B1014</td><td>10 G1/4</td></tr> <tr><td>HA12B0638</td><td>6 G3/8</td></tr> <tr><td>HA12B0838</td><td>8 G3/8</td></tr> <tr><td>HA12B1038</td><td>10 G3/8</td></tr> <tr><td>HA12B1238</td><td>12 G3/8</td></tr> <tr><td>HA12B1012</td><td>10 G1/2</td></tr> <tr><td>HA12B1212</td><td>12 G1/2</td></tr> </tbody> </table>	Ø	connection	HA12B04M5	4 M5	HA12B06M5	6 M5	HA12B0418	4 G1/8	HA12B0618	6 G1/8	HA12B0818	8 G1/8	HA12B0414	4 G1/4	HA12B0614	6 G1/4	HA12B0814	8 G1/4	HA12B1014	10 G1/4	HA12B0638	6 G3/8	HA12B0838	8 G3/8	HA12B1038	10 G3/8	HA12B1238	12 G3/8	HA12B1012	10 G1/2	HA12B1212	12 G1/2	<p>HA14 Lateral Tee male</p>  <table border="1"> <thead> <tr> <th>Ø</th> <th>connection</th> </tr> </thead> <tbody> <tr><td>HA1404M5</td><td>4 M5</td></tr> <tr><td>HA1406M5</td><td>6 M5</td></tr> <tr><td>HA140418</td><td>4 G1/8</td></tr> <tr><td>HA140618</td><td>6 G1/8</td></tr> <tr><td>HA140818</td><td>8 G1/8</td></tr> <tr><td>HA140614</td><td>6 G1/4</td></tr> <tr><td>HA140814</td><td>8 G1/4</td></tr> <tr><td>HA141014</td><td>10 G1/4</td></tr> <tr><td>HA140838</td><td>8 G3/8</td></tr> <tr><td>HA141038</td><td>10 G3/8</td></tr> <tr><td>HA141238</td><td>12 G3/8</td></tr> <tr><td>HA141012</td><td>10 G1/2</td></tr> <tr><td>HA141212</td><td>12 G1/2</td></tr> </tbody> </table>	Ø	connection	HA1404M5	4 M5	HA1406M5	6 M5	HA140418	4 G1/8	HA140618	6 G1/8	HA140818	8 G1/8	HA140614	6 G1/4	HA140814	8 G1/4	HA141014	10 G1/4	HA140838	8 G3/8	HA141038	10 G3/8	HA141238	12 G3/8	HA141012	10 G1/2	HA141212	12 G1/2
Ø	connection																																																																																													
HA1204M5	4 M5																																																																																													
HA1206M5	6 M5																																																																																													
HA120418	4 G1/8																																																																																													
HA120618	6 G1/8																																																																																													
HA120818	8 G1/8																																																																																													
HA120414	4 G1/4																																																																																													
HA120614	6 G1/4																																																																																													
HA120814	8 G1/4																																																																																													
HA121014	10 G1/4																																																																																													
HA120638	6 G3/8																																																																																													
HA120838	8 G3/8																																																																																													
HA121038	10 G3/8																																																																																													
HA121238	12 G3/8																																																																																													
HA121012	10 G1/2																																																																																													
HA121212	12 G1/2																																																																																													
Ø	connection																																																																																													
HA12B04M5	4 M5																																																																																													
HA12B06M5	6 M5																																																																																													
HA12B0418	4 G1/8																																																																																													
HA12B0618	6 G1/8																																																																																													
HA12B0818	8 G1/8																																																																																													
HA12B0414	4 G1/4																																																																																													
HA12B0614	6 G1/4																																																																																													
HA12B0814	8 G1/4																																																																																													
HA12B1014	10 G1/4																																																																																													
HA12B0638	6 G3/8																																																																																													
HA12B0838	8 G3/8																																																																																													
HA12B1038	10 G3/8																																																																																													
HA12B1238	12 G3/8																																																																																													
HA12B1012	10 G1/2																																																																																													
HA12B1212	12 G1/2																																																																																													
Ø	connection																																																																																													
HA1404M5	4 M5																																																																																													
HA1406M5	6 M5																																																																																													
HA140418	4 G1/8																																																																																													
HA140618	6 G1/8																																																																																													
HA140818	8 G1/8																																																																																													
HA140614	6 G1/4																																																																																													
HA140814	8 G1/4																																																																																													
HA141014	10 G1/4																																																																																													
HA140838	8 G3/8																																																																																													
HA141038	10 G3/8																																																																																													
HA141238	12 G3/8																																																																																													
HA141012	10 G1/2																																																																																													
HA141212	12 G1/2																																																																																													
<p>HA14B Low lateral Tee male</p>  <p>NEW</p> <table border="1"> <thead> <tr> <th>Ø</th> <th>connection</th> </tr> </thead> <tbody> <tr><td>HA14B04M5</td><td>4 M5</td></tr> <tr><td>HA14B06M5</td><td>6 M5</td></tr> <tr><td>HA14B0418</td><td>4 G1/8</td></tr> <tr><td>HA14B0618</td><td>6 G1/8</td></tr> <tr><td>HA14B0818</td><td>8 G1/8</td></tr> <tr><td>HA14B0614</td><td>6 G1/4</td></tr> <tr><td>HA14B0814</td><td>8 G1/4</td></tr> <tr><td>HA14B1014</td><td>10 G1/4</td></tr> <tr><td>HA14B0838</td><td>8 G3/8</td></tr> <tr><td>HA14B1038</td><td>10 G3/8</td></tr> <tr><td>HA14B1238</td><td>12 G3/8</td></tr> <tr><td>HA14B1012</td><td>10 G1/2</td></tr> <tr><td>HA14B1212</td><td>12 G1/2</td></tr> </tbody> </table>	Ø	connection	HA14B04M5	4 M5	HA14B06M5	6 M5	HA14B0418	4 G1/8	HA14B0618	6 G1/8	HA14B0818	8 G1/8	HA14B0614	6 G1/4	HA14B0814	8 G1/4	HA14B1014	10 G1/4	HA14B0838	8 G3/8	HA14B1038	10 G3/8	HA14B1238	12 G3/8	HA14B1012	10 G1/2	HA14B1212	12 G1/2	<p>HA16 Central Tee male</p>  <table border="1"> <thead> <tr> <th>Ø</th> <th>connection</th> </tr> </thead> <tbody> <tr><td>HA1604M5</td><td>4 M5</td></tr> <tr><td>HA1606M5</td><td>6 M5</td></tr> <tr><td>HA160418</td><td>4 G1/8</td></tr> <tr><td>HA160618</td><td>6 G1/8</td></tr> <tr><td>HA160818</td><td>8 G1/8</td></tr> <tr><td>HA160614</td><td>6 G1/4</td></tr> <tr><td>HA160814</td><td>8 G1/4</td></tr> <tr><td>HA161014</td><td>10 G1/4</td></tr> <tr><td>HA160838</td><td>8 G3/8</td></tr> <tr><td>HA161038</td><td>10 G3/8</td></tr> <tr><td>HA161238</td><td>12 G3/8</td></tr> <tr><td>HA161012</td><td>10 G1/2</td></tr> <tr><td>HA161212</td><td>12 G1/2</td></tr> </tbody> </table>	Ø	connection	HA1604M5	4 M5	HA1606M5	6 M5	HA160418	4 G1/8	HA160618	6 G1/8	HA160818	8 G1/8	HA160614	6 G1/4	HA160814	8 G1/4	HA161014	10 G1/4	HA160838	8 G3/8	HA161038	10 G3/8	HA161238	12 G3/8	HA161012	10 G1/2	HA161212	12 G1/2	<p>HA16B Low central Tee male</p>  <p>NEW</p> <table border="1"> <thead> <tr> <th>Ø</th> <th>connection</th> </tr> </thead> <tbody> <tr><td>HA16B04M5</td><td>4 M5</td></tr> <tr><td>HA16B06M5</td><td>6 M5</td></tr> <tr><td>HA16B0418</td><td>4 G1/8</td></tr> <tr><td>HA16B0618</td><td>6 G1/8</td></tr> <tr><td>HA16B0818</td><td>8 G1/8</td></tr> <tr><td>HA16B0614</td><td>6 G1/4</td></tr> <tr><td>HA16B0814</td><td>8 G1/4</td></tr> <tr><td>HA16B1014</td><td>10 G1/4</td></tr> <tr><td>HA16B0838</td><td>8 G3/8</td></tr> <tr><td>HA16B1038</td><td>10 G3/8</td></tr> <tr><td>HA16B1238</td><td>12 G3/8</td></tr> <tr><td>HA16B1012</td><td>10 G1/2</td></tr> <tr><td>HA16B1212</td><td>12 G1/2</td></tr> </tbody> </table>	Ø	connection	HA16B04M5	4 M5	HA16B06M5	6 M5	HA16B0418	4 G1/8	HA16B0618	6 G1/8	HA16B0818	8 G1/8	HA16B0614	6 G1/4	HA16B0814	8 G1/4	HA16B1014	10 G1/4	HA16B0838	8 G3/8	HA16B1038	10 G3/8	HA16B1238	12 G3/8	HA16B1012	10 G1/2	HA16B1212	12 G1/2								
Ø	connection																																																																																													
HA14B04M5	4 M5																																																																																													
HA14B06M5	6 M5																																																																																													
HA14B0418	4 G1/8																																																																																													
HA14B0618	6 G1/8																																																																																													
HA14B0818	8 G1/8																																																																																													
HA14B0614	6 G1/4																																																																																													
HA14B0814	8 G1/4																																																																																													
HA14B1014	10 G1/4																																																																																													
HA14B0838	8 G3/8																																																																																													
HA14B1038	10 G3/8																																																																																													
HA14B1238	12 G3/8																																																																																													
HA14B1012	10 G1/2																																																																																													
HA14B1212	12 G1/2																																																																																													
Ø	connection																																																																																													
HA1604M5	4 M5																																																																																													
HA1606M5	6 M5																																																																																													
HA160418	4 G1/8																																																																																													
HA160618	6 G1/8																																																																																													
HA160818	8 G1/8																																																																																													
HA160614	6 G1/4																																																																																													
HA160814	8 G1/4																																																																																													
HA161014	10 G1/4																																																																																													
HA160838	8 G3/8																																																																																													
HA161038	10 G3/8																																																																																													
HA161238	12 G3/8																																																																																													
HA161012	10 G1/2																																																																																													
HA161212	12 G1/2																																																																																													
Ø	connection																																																																																													
HA16B04M5	4 M5																																																																																													
HA16B06M5	6 M5																																																																																													
HA16B0418	4 G1/8																																																																																													
HA16B0618	6 G1/8																																																																																													
HA16B0818	8 G1/8																																																																																													
HA16B0614	6 G1/4																																																																																													
HA16B0814	8 G1/4																																																																																													
HA16B1014	10 G1/4																																																																																													
HA16B0838	8 G3/8																																																																																													
HA16B1038	10 G3/8																																																																																													
HA16B1238	12 G3/8																																																																																													
HA16B1012	10 G1/2																																																																																													
HA16B1212	12 G1/2																																																																																													

HA18
Y parallel male



	Ø	connection
HA1804M5	4	M5
HA1806M5	6	M5
HA180418	4	G1/8
HA180618	6	G1/8
HA180818	8	G1/8
HA180614	6	G1/4
HA180814	8	G1/4
HA181014	10	G1/4
HA180838	8	G3/8
HA181038	10	G3/8
HA181238	12	G3/8
HA181012	10	G1/2
HA181212	12	G1/2

HA19
Intermediate straight



	Ø1	Ø2
HA190400	4	4
HA190600	6	6
HA190604	6	4
HA190800	8	8
HA190806	8	6
HA191000	10	10
HA191008	10	8
HA191200	12	12
HA191210	12	10

HA20
Intermediate elbow



	Ø
HA200400	4
HA200600	6
HA200800	8
HA201000	10
HA201200	12

HA21
Intermediate lateral Tee



	Ø
HA210400	4
HA210600	6
HA210800	8
HA211000	10
HA211200	12

HA22
Intermediate cross



	Ø
HA220400	4
HA220600	6
HA220800	8
HA221000	10
HA221200	12

HA23
Intermediate Y connector



	Ø1	Ø2
HA230404	4	4
HA230604	6	4
HA230606	6	6
HA230806	8	6
HA230808	8	8
HA231008	10	8
HA231010	10	10
HA231210	12	10
HA231212	12	12

HA24
Reducing stem



	Ø1	Ø2
HA240406	4	6
HA240408	4	8
HA240608	6	8
HA240610	6	10
HA240810	8	10
HA240812	8	12
HA241012	10	12

HA25
Y connector with male stem



	Ø
HA250400	4
HA250600	6
HA250800	8
HA251000	10
HA251200	12

HA26
Plug



	Ø
HA260400	4
HA260600	6
HA260800	8
HA261000	10
HA261200	12

HA27
Swivel banjo connector (parallel male thread) with wrench head



	Ø	connection
HA2704M5	4	M5
HA2706M5	6	M5
HA270418	4	G1/8
HA270618	6	G1/8
HA270818	8	G1/8
HA270614	6	G1/4
HA270814	8	G1/4
HA271014	10	G1/4
HA270838	8	G3/8
HA271038	10	G3/8
HA271238	12	G3/8
HA271012	10	G1/2
HA271212	12	G1/2

HA28
Swivel banjo connector parallel male-female



	Ø	connection
HA2804M5	4	M5
HA2806M5	6	M5
HA280418	4	G1/8
HA280618	6	G1/8
HA280818	8	G1/8
HA280614	6	G1/4
HA280814	8	G1/4
HA281014	10	G1/4
HA280838	8	G3/8
HA281038	10	G3/8
HA281238	12	G3/8
HA281012	10	G1/2
HA281212	12	G1/2

HA29
Triple branch lateral Tee



	Ø
HA290400	4
HA290600	6
HA290800	8

HA30
Triple branch lateral Tee



	Ø1	Ø2
HA300604	6	4
HA300804	8	4
HA300806	8	6
HA301006	10	6
HA301008	10	8

HA31
Triple branch lateral Tee male thread



	Ø1	Ø2	connection
HA314618	6	4	G1/8
HA314814	8	4	G1/4
HA316814	8	6	G1/4
HA318138	10	8	G3/8
HA318112	10	8	G1/2

HA32
Triple branch lateral Tee male thread



	Ø	connection
HA320418	4	G1/8
HA320618	6	G1/8
HA320818	8	G1/8
HA320414	4	G1/4
HA320614	6	G1/4
HA320814	8	G1/4
HA320638	6	G3/8
HA320838	8	G3/8

■ HA33

Bulkhead connector



	Ø
HA330004	4
HA330006	6
HA330008	8
HA330010	10
HA330012	12

■ HA34

Threaded bulkhead connector



	Ø	connection
HA340418	4	G1/8
HA340618	6	G1/8
HA340818	8	G1/8
HA340414	4	G1/4
HA340614	6	G1/4
HA340814	8	G1/4
HA341014	10	G1/4
HA340838	8	G3/8
HA341038	10	G3/8
HA341238	12	G3/8
HA341012	10	G1/2
HA341212	12	G1/2

■ HA35

Elbow bulkhead connector



	Ø
HA350004	4
HA350006	6
HA350008	8
HA350010	10
HA350012	12

■ HA38

Stem elbow



	Ø
HA380400	4
HA380600	6
HA380800	8
HA381000	10
HA381200	12

■ HA39

Intermediate double Y



	Ø1	Ø2
HA390604	6	4
HA390804	8	4
HA390806	8	6
HA390808	8	8

NEW

■ HA40

Double Y parallel male



	Ø	connection
HA400418	4	G1/8
HA400618	6	G1/8
HA400818	8	G1/8
HA400614	6	G1/4
HA400814	8	G1/4
HA401014	10	G1/4
HA400638	6	G3/8
HA400838	8	G3/8
HA400612	6	G1/2
HA400812	8	G1/2

NEW

■ HA41

Swivel banjo connector (parallel thread) with allen head



	Ø	connection
HA410418	4	G1/8
HA410618	6	G1/8
HA410818	8	G1/8
HA410414	4	G1/4
HA410614	6	G1/4
HA410814	8	G1/4
HA411014	10	G1/4
HA411214	12	G1/4
HA410438	4	G3/8
HA410638	6	G3/8
HA410838	8	G3/8
HA411038	10	G3/8
HA411238	12	G3/8
HA410812	8	G1/2
HA411012	10	G1/2
HA411212	12	G1/2

NEW

■ HA42

Double banjo connector (parallel thread) with allen head



	Ø	connection
HA420418	4	G1/8
HA420618	6	G1/8
HA420818	8	G1/8
HA420414	4	G1/4
HA420614	6	G1/4
HA420814	8	G1/4
HA421014	10	G1/4
HA421214	12	G1/4
HA420438	4	G3/8
HA420638	6	G3/8
HA420838	8	G3/8
HA421038	10	G3/8
HA421238	12	G3/8
HA420812	8	G1/2
HA421012	10	G1/2
HA421212	12	G1/2

NEW

■ HA43

Triple banjo connector (parallel thread) with allen head



	Ø	connection
HA430418	4	G1/8
HA430618	6	G1/8
HA430818	8	G1/8
HA430414	4	G1/4
HA430614	6	G1/4
HA430814	8	G1/4
HA431014	10	G1/4
HA431214	12	G1/4
HA430438	4	G3/8
HA430638	6	G3/8
HA430838	8	G3/8
HA431038	10	G3/8
HA431238	12	G3/8
HA430812	8	G1/2
HA431012	10	G1/2
HA431212	12	G1/2

NEW

■ Teflon coated taper thread

(available upon request for all HA models)



■ HC01/HC02



■ HC04



■ HC01T/HC02T



■ HC01L/HC02L



CHARACTERISTICS

Temperature	0 ÷ 60 °C
Fluid	compressed air, vacuum
Working pressure	-0,99 ÷ 9 bar
Body	technopolymer
Fixing elements	nickel-plated brass with O-ring in NBR
Clamp	stainless steel
Release ring	technopolymer
Application fields	pneumatic circuits
Recommended hoses	polyamide PA 10.12, polyurethane Sh.A98, co-polyurethane Sh.55D

<p>HAR04 Miniature straight male</p>  <table border="0"> <thead> <tr> <th></th> <th>∅</th> <th>connection</th> </tr> </thead> <tbody> <tr> <td>HAR0403M3</td> <td>3</td> <td>M3</td> </tr> <tr> <td>HAR0404M3</td> <td>4</td> <td>M3</td> </tr> <tr> <td>HAR0404M5</td> <td>4</td> <td>M5</td> </tr> </tbody> </table>		∅	connection	HAR0403M3	3	M3	HAR0404M3	4	M3	HAR0404M5	4	M5	<p>HAR10B Miniature swivel elbow male</p>  <table border="0"> <thead> <tr> <th></th> <th>∅</th> <th>connection</th> </tr> </thead> <tbody> <tr> <td>HAR10B03M3</td> <td>3</td> <td>M3</td> </tr> <tr> <td>HAR10B04M3</td> <td>4</td> <td>M3</td> </tr> <tr> <td>HAR10B04M5</td> <td>4</td> <td>M5</td> </tr> </tbody> </table>		∅	connection	HAR10B03M3	3	M3	HAR10B04M3	4	M3	HAR10B04M5	4	M5	<p>HAR12B Miniature extended swivel elbow male</p>  <table border="0"> <thead> <tr> <th></th> <th>∅</th> <th>connection</th> </tr> </thead> <tbody> <tr> <td>HAR12B03M3</td> <td>3</td> <td>M3</td> </tr> <tr> <td>HAR12B04M3</td> <td>4</td> <td>M3</td> </tr> <tr> <td>HAR12B04M5</td> <td>4</td> <td>M5</td> </tr> </tbody> </table>		∅	connection	HAR12B03M3	3	M3	HAR12B04M3	4	M3	HAR12B04M5	4	M5
	∅	connection																																				
HAR0403M3	3	M3																																				
HAR0404M3	4	M3																																				
HAR0404M5	4	M5																																				
	∅	connection																																				
HAR10B03M3	3	M3																																				
HAR10B04M3	4	M3																																				
HAR10B04M5	4	M5																																				
	∅	connection																																				
HAR12B03M3	3	M3																																				
HAR12B04M3	4	M3																																				
HAR12B04M5	4	M5																																				
<p>HAR14B Miniature low lateral Tee male</p>  <table border="0"> <thead> <tr> <th></th> <th>∅</th> <th>connection</th> </tr> </thead> <tbody> <tr> <td>HAR14B03M3</td> <td>3</td> <td>M3</td> </tr> <tr> <td>HAR14B04M3</td> <td>4</td> <td>M3</td> </tr> <tr> <td>HAR14B04M5</td> <td>4</td> <td>M5</td> </tr> </tbody> </table>		∅	connection	HAR14B03M3	3	M3	HAR14B04M3	4	M3	HAR14B04M5	4	M5	<p>HAR16B Miniature low central Tee male</p>  <table border="0"> <thead> <tr> <th></th> <th>∅</th> <th>connection</th> </tr> </thead> <tbody> <tr> <td>HAR16B03M3</td> <td>3</td> <td>M3</td> </tr> <tr> <td>HAR16B04M3</td> <td>4</td> <td>M3</td> </tr> <tr> <td>HAR16B04M5</td> <td>4</td> <td>M5</td> </tr> </tbody> </table>		∅	connection	HAR16B03M3	3	M3	HAR16B04M3	4	M3	HAR16B04M5	4	M5	<p>HAR19 Miniature intermediate straight</p>  <table border="0"> <thead> <tr> <th></th> <th>∅</th> </tr> </thead> <tbody> <tr> <td>HAR190300</td> <td>3</td> </tr> <tr> <td>HAR190400</td> <td>4</td> </tr> </tbody> </table>		∅	HAR190300	3	HAR190400	4						
	∅	connection																																				
HAR14B03M3	3	M3																																				
HAR14B04M3	4	M3																																				
HAR14B04M5	4	M5																																				
	∅	connection																																				
HAR16B03M3	3	M3																																				
HAR16B04M3	4	M3																																				
HAR16B04M5	4	M5																																				
	∅																																					
HAR190300	3																																					
HAR190400	4																																					
<p>HAR20 Miniature intermediate elbow</p>  <table border="0"> <thead> <tr> <th></th> <th>∅</th> </tr> </thead> <tbody> <tr> <td>HAR200300</td> <td>3</td> </tr> <tr> <td>HAR200400</td> <td>4</td> </tr> </tbody> </table>		∅	HAR200300	3	HAR200400	4	<p>HAR21 Miniature intermediate Tee</p>  <table border="0"> <thead> <tr> <th></th> <th>∅</th> </tr> </thead> <tbody> <tr> <td>HAR210300</td> <td>3</td> </tr> <tr> <td>HAR210400</td> <td>4</td> </tr> </tbody> </table>		∅	HAR210300	3	HAR210400	4	<p>HAR23 Miniature intermediate Y</p>  <table border="0"> <thead> <tr> <th></th> <th>∅</th> </tr> </thead> <tbody> <tr> <td>HAR230300</td> <td>3</td> </tr> <tr> <td>HAR230400</td> <td>4</td> </tr> </tbody> </table>		∅	HAR230300	3	HAR230400	4																		
	∅																																					
HAR200300	3																																					
HAR200400	4																																					
	∅																																					
HAR210300	3																																					
HAR210400	4																																					
	∅																																					
HAR230300	3																																					
HAR230400	4																																					

CHARACTERISTICS

Temperature	-20 ÷ 70 °C (based on the type of tube)
Fluid	compressed air, vacuum
Max pressure	16 bar
Working pressure	-0,99 ÷ 10 bar
Body	nickel-plated brass
Fixing elements	nickel-plated brass with O-ring in NBR for parallel thread version (standard) Teflon coating for taper thread version (upon request)
Clamp	stainless steel AISI 316
Release ring	nickel-plated brass
Application fields	pneumatic circuits
Recommended hoses	polyamide PA 10.12, polyurethane Sh.A98, co-polyurethane Sh.55D

HB04
 Straight parallel male


Ø	connection	Ø	connection
HB0403M3	3 M3	HB040514	5 G1/4
HB0403M5	3 M5	HB040414	4 G1/4
HB0404M5	4 M5	HB041438	14 G3/8
HB0405M5	5 M5	HB041238	12 G3/8
HB0406M5	6 M5	HB041038	10 G3/8
HB041018	10 G1/8	HB040838	8 G3/8
HB040818	8 G1/8	HB040638	6 G3/8
HB040618	6 G1/8	HB041412	14 G1/2
HB040518	5 G1/8	HB041212	12 G1/2
HB040418	4 G1/8	HB041012	10 G1/2
HB041214	12 G1/4	HB040812	8 G1/2
HB041014	10 G1/4		
HB040814	8 G1/4		
HB040614	6 G1/4		

HB07
 Straight female


Ø	connection
HB0704M5	4 M5
HB070418	4 G1/8
HB070518	5 G1/8
HB070618	6 G1/8
HB070818	8 G1/8
HB071038	10 G3/8
HB070414	4 G1/4
HB070514	5 G1/4
HB070614	6 G1/4
HB070814	8 G1/4
HB071014	10 G1/4

HB08
 Swivel elbow female


Ø	connection
HB080418	4 G1/8
HB080618	6 G1/8
HB080818	8 G1/8
HB080414	4 G1/4
HB080614	6 G1/4
HB080814	8 G1/4

HB10
 Swivel elbow male


Ø	connection	Ø	connection
HB1004M5	4 M5	HB100838	8 G3/8
HB1005M5	5 M5	HB101038	10 G3/8
HB1006M5	6 M5	HB101238	12 G3/8
HB100418	4 G1/8	HB101438	14 G3/8
HB100518	5 G1/8	HB101012	10 G1/2
HB100618	6 G1/8	HB101212	12 G1/2
HB100818	8 G1/8	HB101412	14 G1/2
HB100414	4 G1/4		
HB100514	5 G1/4		
HB100614	6 G1/4		
HB100814	8 G1/4		
HB101014	10 G1/4		
HB101214	12 G1/4		
HB100638	6 G3/8		

HB12
 Extended swivel elbow male


Ø	connection
HB1204M5	4 M5
HB1206M5	6 M5
HB120418	4 G1/8
HB120618	6 G1/8
HB120818	8 G1/8
HB120414	4 G1/4
HB120614	6 G1/4
HB120814	8 G1/4
HB121014	10 G1/4
HB120838	8 G3/8
HB121038	10 G3/8

HB14
 Lateral Tee parallel male


Ø	connection
HB1404M5	4 M5
HB140418	4 G1/8
HB140618	6 G1/8
HB140818	8 G1/8
HB140414	4 G1/4
HB140614	6 G1/4
HB140814	8 G1/4
HB141014	10 G1/4
HB141214	12 G1/4
HB140838	8 G3/8
HB141038	10 G3/8
HB141238	12 G3/8
HB141412	14 G1/2

HB16
 Central Tee male


Ø	connection
HB1604M5	4 M5
HB160418	4 G1/8
HB160618	6 G1/8
HB160818	8 G1/8
HB160414	4 G1/4
HB160614	6 G1/4
HB160814	8 G1/4
HB161014	10 G1/4
HB161214	12 G1/4
HB160838	8 G3/8
HB161038	10 G3/8
HB161238	12 G3/8
HB161412	14 G1/2

HB19
 Straight


Ø1	Ø2
HB190303	3 3
HB190404	4 4
HB190505	5 5
HB190604	6 4
HB190606	6 6
HB190806	8 6
HB190808	8 8
HB191008	10 8
HB191010	10 10
HB191210	12 10
HB191212	12 12
HB191412	14 12
HB191414	14 14

■ **HB20**

Intermediate elbow



	∅
HB200300	3
HB200400	4
HB200500	5
HB200600	6
HB200800	8
HB201000	10
HB201200	12
HB201400	14

■ **HB21**

Intermediate Tee



	∅1	∅2
HB210300	3	3
HB210400	4	4
HB210500	5	5
HB210600	6	6
HB210604	6	4
HB210800	8	8
HB210806	8	6
HB211000	10	10
HB211008	10	8
HB211200	12	12
HB211400	14	14

■ **HB24**

Reducing stem



	∅1	∅2		∅1	∅2
HB240405	4	5	HB240612	6	12
HB240406	4	6	HB240614	6	14
HB240408	4	8	HB240806	8	6
HB240412	4	12	HB240810	8	10
HB240414	4	14	HB240812	8	12
HB240506	5	6	HB240814	8	14
HB240508	5	8	HB241012	10	12
HB240604	6	4	HB241014	10	14
HB240608	6	8	HB241214	12	14
HB240610	6	10			

■ **HB26**

Plug



	∅
HB260400	4
HB260500	5
HB260600	6
HB260800	8
HB261000	10
HB261200	12
HB261400	14

■ **HB27**

Swivel banjo connector (parallel thread) with allen head



	∅	connection		∅	connection
HB2703M3	3	M3	HB270614	6	G1/4
HB2703M5	3	M5	HB270814	8	G1/4
HB2704M5	4	M5	HB271014	10	G1/4
HB2705M5	5	M5	HB271214	12	G1/4
HB270418	4	G1/8	HB270838	8	G3/8
HB270518	5	G1/8	HB271038	10	G3/8
HB270618	6	G1/8	HB271238	12	G3/8
HB270818	8	G1/8			

■ **HB33**

Bulkhead connector



	∅
HB330004	4
HB330005	5
HB330006	6
HB330008	8
HB330010	10
HB330012	12
HB330014	14

■ **HB34**

Threaded bulkhead connector



	∅	connection
HB340418	4	G1/8
HB340618	6	G1/8
HB340818	8	G1/8
HB340614	6	G1/4
HB340814	8	G1/4

■ **HB35**

Elbow bulkhead connector



	∅
HB350004	4
HB350006	6
HB350008	8
HB350010	10

■ **HB38**

Stem elbow



	∅1	∅2
HB380400	4	4
HB380406	4	6
HB380600	6	6
HB380608	6	8
HB380800	8	8
HB381000	10	10
HB381200	12	12

■ **HB39**

Extended stem elbow



	∅1	∅2
HB390400	4	4
HB390406	4	6
HB390600	6	6
HB390608	6	8
HB390800	8	8

HB40
Single banjo (without bolt)



	∅	bolt
HB4004M5	4	M5
HB4005M5	5	M5
HB4006M5	6	M5
HB400418	4	G1/8
HB400518	5	G1/8
HB400618	6	G1/8
HB400818	8	G1/8
HB400614	6	G1/4
HB400814	8	G1/4
HB401014	10	G1/4
HB401214	12	G1/4
HB400838	8	G3/8
HB401038	10	G3/8
HB401238	12	G3/8

HB41
Double banjo (without bolt)



	∅	bolt
HB4104M5	4	M5
HB4105M5	5	M5
HB410418	4	G1/8
HB410518	5	G1/8
HB410618	6	G1/8
HB410818	8	G1/8
HB410614	6	G1/4
HB410814	8	G1/4
HB411014	10	G1/4
HB410838	8	G3/8
HB411038	10	G3/8
HB411238	12	G3/8

HB42
Single banjo bolt



	connection
HB4200M5	M5
HB420018	G1/8
HB420014	G1/4
HB420038	G3/8

HB43
Double banjo bolt



	connection
HB430018	G1/8
HB430014	G1/4
HB430038	G3/8

HB44
Triple banjo bolt



	connection
HB440018	G1/8
HB440014	G1/4
HB440038	G3/8

HB45
Swivel banjo central Tee (parallel male) with allen head



	∅	connection
HB4504M5	4	M5
HB4505M5	5	M5
HB450418	4	G1/8
HB450518	5	G1/8
HB450618	6	G1/8
HB450818	8	G1/8
HB450614	6	G1/4
HB450814	8	G1/4
HB451014	10	G1/4
HB450838	8	G3/8
HB451038	10	G3/8
HB451238	12	G3/8

HB47
Double swivel banjo connector (male thread) with allen head



	∅	connection
HB470418	4	G1/8
HB470618	6	G1/8
HB470818	8	G1/8
HB470614	6	G1/4
HB470814	8	G1/4
HB471014	10	G1/4
HB471214	12	G1/4

HB48
Triple swivel banjo connector (parallel thread) with allen head



	∅	connection
HB480418	4	G1/8
HB480618	6	G1/8
HB480818	8	G1/8
HB480614	6	G1/4
HB480814	8	G1/4
HB481014	10	G1/4
HB481214	12	G1/4

HB49
Double stem



	∅
HB490400	4
HB490500	5
HB490600	6
HB490800	8
HB491000	10
HB491200	12
HB491400	14

HB51
Adaptor parallel male



	∅	connection		∅	connection
HB5104M5	4	M5	HB510614	6	G1/4
HB5105M5	5	M5	HB510814	8	G1/4
HB5106M5	6	M5	HB511014	10	G1/4
HB510418	4	G1/8	HB511214	12	G1/4
HB510518	5	G1/8	HB510838	8	G3/8
HB510618	6	G1/8	HB511038	10	G3/8
HB510818	8	G1/8	HB511238	12	G3/8
HB511018	10	G1/8	HB511438	14	G3/8
HB510414	4	G1/4	HB511212	12	G1/2
HB510514	5	G1/4	HB511412	14	G1/2

HB53
Fixed elbow taper male



	∅	connection
HB530418	4	R1/8
HB530518	5	R1/8
HB530618	6	R1/8
HB530818	8	R1/8
HB530614	6	R1/4
HB530814	8	R1/4
HB531014	10	R1/4

CHARACTERISTICS

Temperature	-20 ÷ 80 °C (based on the type of tube)
Fluid	compressed air, vacuum
Max pressure	15 bar
Working pressure	-0,99 ÷ 10 bar
Body	technopolymer
Fixing elements	nickel-plated brass with O-ring in NBR for parallel thread version (standard) Teflon coating for taper thread version (upon request)
Clamp	stainless steel
Release ring	technopolymer
Application fields	pneumatic circuits
Recommended hoses	polyamide PA 10.12, polyurethane Sh.A98, co-polyurethane Sh.55D

Flow regulators in technopolymer

HC01/HC02

One-way banjo flow regulator



exhaust	supply	Ø	connection
HC0104M5	HC0204M5	4	M5
HC0106M5	HC0206M5	6	M5
HC010418	HC020418	4	G1/8
HC010618	HC020618	6	G1/8
HC010818	HC020818	8	G1/8
HC010414	HC020414	4	G1/4
HC010614	HC020614	6	G1/4
HC010814	HC020814	8	G1/4
HC011014	HC021014	10	G1/4
HC010838	HC020838	8	G3/8
HC011038	HC021038	10	G3/8
HC011238	HC021238	12	G3/8
HC011012	HC021012	10	G1/2
HC011212	HC021212	12	G1/2

HC01L /HC02L

One-way in-line swivel banjo flow regulator

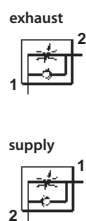


exhaust	supply	Ø	connection
HC01L0418	HC02L0418	4	G1/8
HC01L0618	HC02L0618	6	G1/8
HC01L0818	HC02L0818	8	G1/8
HC01L0414	HC02L0414	4	G1/4
HC01L0614	HC02L0614	6	G1/4
HC01L0814	HC02L0814	8	G1/4
HC01L1014	HC02L1014	10	G1/4
HC01L1214	HC02L1214	12	G1/4
HC01L1038	HC02L1038	10	G3/8
HC01L1238	HC02L1238	12	G3/8

NEW

HC01T/HC02T

One-way swivel banjo flow regulator - screwdriver slot



exhaust	supply	Ø	connection
HC01T0418	HC02T0418	4	G1/8
HC01T0618	HC02T0618	6	G1/8
HC01T0818	HC02T0818	8	G1/8
HC01T1018	HC02T1018	10	G1/8
HC01T1218	HC02T1218	12	G1/8
HC01T0614	HC02T0614	6	G1/4
HC01T0814	HC02T0814	8	G1/4
HC01T1014	HC02T1014	10	G1/4
HC01T1214	HC02T1214	12	G1/4
HC01T0638	HC02T0638	6	G3/8
HC01T0838	HC02T0838	8	G3/8
HC01T1038	HC02T1038	10	G3/8
HC01T1238	HC02T1238	12	G3/8

NEW

HC04

One-way in-line intermediate flow regulator



	Ø1
HC040404	4
HC040606	6
HC040808	8
HC041010	10
HC041212	12

CHARACTERISTICS

Temperature	0 ÷ 70 °C
Fluid	compressed air
Max pressure	10 bar
Working pressure	0,3 ÷ 10 bar

Flow regulators with metallic body

5

■ **HC21/HC22**

One-way banjo flow regulator



	exhaust	supply	Ø	connection
exhaust	HC2104M5	HC2204M5	4	M5
	HC210418	HC220418	4	G1/8
	HC210618	HC220618	6	G1/8
	HC210818	HC220818	8	G1/8
	HC210614	HC220614	6	G1/4
supply	HC210814	HC220814	8	G1/4
	HC211014	HC221014	10	G1/4

■ **HC18/HC19**

One-way banjo flow regulator - screwdriver slot



	exhaust	supply	Ø	connection
exhaust	HC1804M5	HC1904M5	4	M5
	HC180418	HC190418	4	G1/8
	HC180618	HC190618	6	G1/8
	HC180818	HC190818	8	G1/8
	HC180614	HC190614	6	G1/4
supply	HC180814	HC190814	8	G1/4
	HC181014	HC191014	10	G1/4

■ **HC27/HC28**

One-way threaded flow regulator male/female



	exhaust	supply	connection
exhaust	HC27M5M5	HC28M5M5	M5
	HC271818	HC281818	G1/8
	HC271414	HC281414	G1/4
	HC273838	HC283838	G3/8
	HC271212	HC281212	G1/2

Non-return valve

■ **HC13**

Non-return valve F-F



	connection
HC1300M5	M5
HC130018	G1/8
HC130014	G1/4
HC130038	G3/8
HC130012	G1/2

High temperature seals upon request

■ **HC14**

Non-return valve F-M



	connection
HC140018	G1/8
HC140014	G1/4

High temperature seals upon request

■ **HC15**

Non-return valve with push-in tube connections



	Ø
HC150004	4
HC150006	6
HC150008	8

■ **HC16**

Non-return valve with push-in tube connections



	Ø
HC160404	4
HC160606	6
HC160808	8
HC161010	10
HC161212	12

NEW

■ **HC17**

Non-return valve threaded connection



	Ø	connection
HC170418	4	G1/8
HC170618	6	G1/8
HC170818	8	G1/8
HC170614	6	G1/4
HC170814	8	G1/4
HC171038	10	G3/8
HC171238	12	G3/8
HC171012	10	G1/2
HC171212	12	G1/2

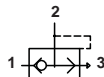
NEW

Quick exhaust valves

■ HC06

Quick exhaust valve

flow rate at 6 bar (NI/min)



	connection	1 → 2	2 → 3
HC0600M5	M5	220	300
HC060018	G1/8	680	1100
HC060014	G1/4	1200	2100
HC060038	G3/8	2300	4800
HC060012	G1/2	3400	6100
HC060034	G3/4	3200	8750
HC060001	G1	2900	10.750

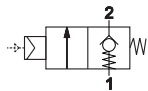
Blocking valve

Miniature pressure regulator

■ HC34



	M	F	flow rate at 6 bar (NI/min)
HC3418M5	G1/8	M5	400
HC3414M5	G1/4	M5	850
HC343818	G3/8	G1/8	1250



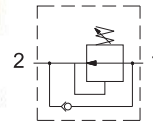
HB40 Single banjo (without bolt)



■ HC35



	connection	flow rate at 6 bar (NI/min)
HC350018	G1/8	580
HC350014	G1/4	750



HB40 Single banjo (without bolt)



CHARACTERISTICS

Temperature

0 ÷ 70 °C

0 ÷ 60 °C (technopolymer HC11-12)

Fluid

compressed air, vacuum

Max pressure

15 bar

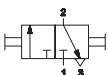
Working pressure

-0,99 ÷ 10 bar

Line manual valve

■ HC05

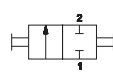
Slide valve



	connection
HC0500M5	M5
HC050018	G1/8
HC050014	G1/4
HC050038	G3/8
HC050012	G1/2
HC050034	G3/4

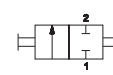
■ HC07

Ball valve F-F



■ HC08

Ball valve M-F

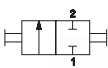


	connection
HC070018	G1/8
HC070014	G1/4
HC070038	G3/8
HC070012	G1/2
HC070034	G3/4

	connection
HC080018	G1/8
HC080014	G1/4
HC080038	G3/8
HC080012	G1/2
HC080034	G3/4

■ HC09

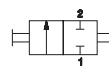
Miniature ball valve F-F with black handle



	connection
HC090018	G1/8
HC090014	G1/4

■ HC10

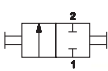
Miniature ball valve M-F with black handle



	connection
HC100018	G1/8
HC100014	G1/4

■ HC11

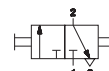
Manual 2/2 minivalve



	Ø
HC110606	6
HC110808	8
HC111010	10
HC111212	12

■ HC12

Manual 3/2 minivalve



	Ø
HC120606	6
HC120808	8
HC121010	10
HC121212	12

Silencers

5

■ **HC51**

Sintered bronze flat silencer



	connection
HC5100M5	M5
HC510018	G1/8
HC510014	G1/4
HC510038	G3/8
HC510012	G1/2
HC510034	G3/4
HC510001	G1
HC510112	G1 1/2

■ **HC52**

Sintered bronze cone silencer



	connection
HC5200M5	M5
HC520018	G1/8
HC520014	G1/4
HC520038	G3/8
HC520012	G1/2
HC520034	G3/4
HC520001	G1

■ **HC53**

Sintered bronze cone silencer (with square wrench head)



	connection
HC5300M5	M5
HC530018	G1/8
HC530014	G1/4
HC530038	G3/8
HC530012	G1/2
HC530034	G3/4
HC530001	G1

■ **HC54**

Silencer with exhaust flow regulator (narrow)



	connection
HC5400M5	M5
HC540018	G1/8
HC540014	G1/4
HC540038	G3/8
HC540012	G1/2
HC540034	G3/4
HC540001	G1

■ **HC55**

Silencer with exhaust flow regulator



	connection
HC5500M5	M5
HC550018	G1/8
HC550014	G1/4
HC550038	G3/8
HC550012	G1/2
HC550034	G3/4
HC550001	G1

■ **HC56**

Technopolymer dynamic silencer



	connection
HC560018	G1/8
HC560014	G1/4
HC560038	G3/8
HC560012	G1/2
HC560034	G3/4
HC560001	G1

■ **HC57**

Polyethylene plastic silencer



	connection
HC5700M5	M5
HC570018	G1/8
HC570014	G1/4
HC570038	G3/8
HC570012	G1/2
HC570034	G3/4
HC570001	G1

■ **HC58**

Technopolymer silencer



	connection
HC580018	G1/8
HC580014	G1/4
HC580038	G3/8
HC580012	G1/2
HC580034	G3/4
HC580001	G1

■ **HC59**

Silencer with dome-shaped steel head



	connection
HC5900M5	M5
HC590018	G1/8
HC590014	G1/4
HC590038	G3/8
HC590012	G1/2
HC590034	G3/4
HC590001	G1

■ **HC60**

Cone silencer with hexagon nipple



	connection
HC6000M5	M5
HC600018	G1/8
HC600014	G1/4
HC600038	G3/8
HC600012	G1/2
HC600034	G3/4
HC600001	G1
HC600112	G1 1/2

■ **HC61**
















Recessed silencer



	connection
HC6100M5	M5
HC610018	G1/8
HC610014	G1/4
HC610038	G3/8
HC610012	G1/2
HC610034	G3/4
HC610001	G1

CHARACTERISTICS

Temperature	-15 ÷ +80 °C
Max pressure	50 bar
Body	nickel-plated brass, aluminium, zinc-plated steel
Application fields	pneumatic circuits, low-pressure oleodynamic and hydraulic circuits, vacuum

<p>■ HD01 Parallel nipple</p>  <table border="1"> <thead> <tr> <th></th> <th>connection 1</th> <th>connection 2</th> <th>key</th> </tr> </thead> <tbody> <tr><td>HD01M5M5</td><td>M5</td><td>M5</td><td>8</td></tr> <tr><td>HD01M518</td><td>M5</td><td>G1/8</td><td>14</td></tr> <tr><td>HD011818</td><td>G1/8</td><td>G1/8</td><td>14</td></tr> <tr><td>HD011814</td><td>G1/8</td><td>G1/4</td><td>17</td></tr> <tr><td>HD011838</td><td>G1/8</td><td>G3/8</td><td>19</td></tr> <tr><td>HD011414</td><td>G1/4</td><td>G1/4</td><td>17</td></tr> <tr><td>HD011438</td><td>G1/4</td><td>G3/8</td><td>19</td></tr> <tr><td>HD011412</td><td>G1/4</td><td>G1/2</td><td>24</td></tr> <tr><td>HD013838</td><td>G3/8</td><td>G3/8</td><td>19</td></tr> <tr><td>HD013812</td><td>G3/8</td><td>G1/2</td><td>24</td></tr> <tr><td>HD011212</td><td>G1/2</td><td>G1/2</td><td>24</td></tr> <tr><td>HD011234</td><td>G1/2</td><td>G3/4</td><td>30</td></tr> <tr><td>HD013434</td><td>G3/4</td><td>G3/4</td><td>30</td></tr> </tbody> </table>		connection 1	connection 2	key	HD01M5M5	M5	M5	8	HD01M518	M5	G1/8	14	HD011818	G1/8	G1/8	14	HD011814	G1/8	G1/4	17	HD011838	G1/8	G3/8	19	HD011414	G1/4	G1/4	17	HD011438	G1/4	G3/8	19	HD011412	G1/4	G1/2	24	HD013838	G3/8	G3/8	19	HD013812	G3/8	G1/2	24	HD011212	G1/2	G1/2	24	HD011234	G1/2	G3/4	30	HD013434	G3/4	G3/4	30	<p>■ HD02 Taper nipple</p>  <table border="1"> <thead> <tr> <th></th> <th>connection 1</th> <th>connection 2</th> <th>key</th> </tr> </thead> <tbody> <tr><td>HD021818</td><td>R1/8</td><td>R1/8</td><td>12</td></tr> <tr><td>HD021814</td><td>R1/8</td><td>R1/4</td><td>14</td></tr> <tr><td>HD021838</td><td>R1/8</td><td>R3/8</td><td>17</td></tr> <tr><td>HD021414</td><td>R1/4</td><td>R1/4</td><td>14</td></tr> <tr><td>HD021438</td><td>R1/4</td><td>R3/8</td><td>17</td></tr> <tr><td>HD021412</td><td>R1/4</td><td>R1/2</td><td>22</td></tr> <tr><td>HD023838</td><td>R3/8</td><td>R3/8</td><td>17</td></tr> <tr><td>HD023812</td><td>R3/8</td><td>R1/2</td><td>22</td></tr> <tr><td>HD021212</td><td>R1/2</td><td>R1/2</td><td>22</td></tr> <tr><td>HD021234</td><td>R1/2</td><td>R3/4</td><td>27</td></tr> <tr><td>HD023434</td><td>R3/4</td><td>R3/4</td><td>27</td></tr> <tr><td>HD023401</td><td>R3/4</td><td>R1</td><td>34</td></tr> <tr><td>HD020101</td><td>R1</td><td>R1</td><td>34</td></tr> </tbody> </table>		connection 1	connection 2	key	HD021818	R1/8	R1/8	12	HD021814	R1/8	R1/4	14	HD021838	R1/8	R3/8	17	HD021414	R1/4	R1/4	14	HD021438	R1/4	R3/8	17	HD021412	R1/4	R1/2	22	HD023838	R3/8	R3/8	17	HD023812	R3/8	R1/2	22	HD021212	R1/2	R1/2	22	HD021234	R1/2	R3/4	27	HD023434	R3/4	R3/4	27	HD023401	R3/4	R1	34	HD020101	R1	R1	34	<p>■ HD03 Female socket</p>  <table border="1"> <thead> <tr> <th></th> <th>connection</th> <th>key</th> </tr> </thead> <tbody> <tr><td>HD0300M5</td><td>M5</td><td>8</td></tr> <tr><td>HD030018</td><td>G1/8</td><td>14</td></tr> <tr><td>HD030014</td><td>G1/4</td><td>17</td></tr> <tr><td>HD030038</td><td>G3/8</td><td>22</td></tr> <tr><td>HD030012</td><td>G1/2</td><td>26</td></tr> <tr><td>HD030034</td><td>G3/4</td><td>32</td></tr> </tbody> </table>		connection	key	HD0300M5	M5	8	HD030018	G1/8	14	HD030014	G1/4	17	HD030038	G3/8	22	HD030012	G1/2	26	HD030034	G3/4	32
	connection 1	connection 2	key																																																																																																																																				
HD01M5M5	M5	M5	8																																																																																																																																				
HD01M518	M5	G1/8	14																																																																																																																																				
HD011818	G1/8	G1/8	14																																																																																																																																				
HD011814	G1/8	G1/4	17																																																																																																																																				
HD011838	G1/8	G3/8	19																																																																																																																																				
HD011414	G1/4	G1/4	17																																																																																																																																				
HD011438	G1/4	G3/8	19																																																																																																																																				
HD011412	G1/4	G1/2	24																																																																																																																																				
HD013838	G3/8	G3/8	19																																																																																																																																				
HD013812	G3/8	G1/2	24																																																																																																																																				
HD011212	G1/2	G1/2	24																																																																																																																																				
HD011234	G1/2	G3/4	30																																																																																																																																				
HD013434	G3/4	G3/4	30																																																																																																																																				
	connection 1	connection 2	key																																																																																																																																				
HD021818	R1/8	R1/8	12																																																																																																																																				
HD021814	R1/8	R1/4	14																																																																																																																																				
HD021838	R1/8	R3/8	17																																																																																																																																				
HD021414	R1/4	R1/4	14																																																																																																																																				
HD021438	R1/4	R3/8	17																																																																																																																																				
HD021412	R1/4	R1/2	22																																																																																																																																				
HD023838	R3/8	R3/8	17																																																																																																																																				
HD023812	R3/8	R1/2	22																																																																																																																																				
HD021212	R1/2	R1/2	22																																																																																																																																				
HD021234	R1/2	R3/4	27																																																																																																																																				
HD023434	R3/4	R3/4	27																																																																																																																																				
HD023401	R3/4	R1	34																																																																																																																																				
HD020101	R1	R1	34																																																																																																																																				
	connection	key																																																																																																																																					
HD0300M5	M5	8																																																																																																																																					
HD030018	G1/8	14																																																																																																																																					
HD030014	G1/4	17																																																																																																																																					
HD030038	G3/8	22																																																																																																																																					
HD030012	G1/2	26																																																																																																																																					
HD030034	G3/4	32																																																																																																																																					
<p>■ HD04 Reduction M-F taper thread</p>  <table border="1"> <thead> <tr> <th></th> <th>connection M</th> <th>connection F</th> <th>key</th> </tr> </thead> <tbody> <tr><td>HD041814</td><td>R1/4</td><td>G1/8</td><td>14</td></tr> <tr><td>HD041838</td><td>R3/8</td><td>G1/8</td><td>17</td></tr> <tr><td>HD041812</td><td>R1/2</td><td>G1/8</td><td>22</td></tr> <tr><td>HD041438</td><td>R3/8</td><td>G1/4</td><td>17</td></tr> <tr><td>HD041412</td><td>R1/2</td><td>G1/4</td><td>22</td></tr> <tr><td>HD043812</td><td>R1/2</td><td>G3/8</td><td>22</td></tr> <tr><td>HD043834</td><td>R3/4</td><td>G3/8</td><td>27</td></tr> <tr><td>HD041234</td><td>R3/4</td><td>G1/2</td><td>27</td></tr> </tbody> </table>		connection M	connection F	key	HD041814	R1/4	G1/8	14	HD041838	R3/8	G1/8	17	HD041812	R1/2	G1/8	22	HD041438	R3/8	G1/4	17	HD041412	R1/2	G1/4	22	HD043812	R1/2	G3/8	22	HD043834	R3/4	G3/8	27	HD041234	R3/4	G1/2	27	<p>■ HD05 Reduction M-F parallel thread</p>  <table border="1"> <thead> <tr> <th></th> <th>connection M</th> <th>connection F</th> <th>key</th> </tr> </thead> <tbody> <tr><td>HD05M518</td><td>G1/8</td><td>M5</td><td>14</td></tr> <tr><td>HD051814</td><td>G1/4</td><td>G1/8</td><td>17</td></tr> <tr><td>HD051838</td><td>G3/8</td><td>G1/8</td><td>19</td></tr> <tr><td>HD051812</td><td>G1/2</td><td>G1/8</td><td>24</td></tr> <tr><td>HD051438</td><td>G3/8</td><td>G1/4</td><td>19</td></tr> <tr><td>HD051412</td><td>G1/2</td><td>G1/4</td><td>24</td></tr> <tr><td>HD053812</td><td>G1/2</td><td>G3/8</td><td>24</td></tr> <tr><td>HD053834</td><td>G3/4</td><td>G3/8</td><td>30</td></tr> <tr><td>HD051234</td><td>G3/4</td><td>G1/2</td><td>30</td></tr> </tbody> </table>		connection M	connection F	key	HD05M518	G1/8	M5	14	HD051814	G1/4	G1/8	17	HD051838	G3/8	G1/8	19	HD051812	G1/2	G1/8	24	HD051438	G3/8	G1/4	19	HD051412	G1/2	G1/4	24	HD053812	G1/2	G3/8	24	HD053834	G3/4	G3/8	30	HD051234	G3/4	G1/2	30	<p>■ HD06 Extension M-F taper thread</p>  <table border="1"> <thead> <tr> <th></th> <th>connection M</th> <th>connection F</th> <th>key</th> </tr> </thead> <tbody> <tr><td>HD061818</td><td>R1/8</td><td>G1/8</td><td>14</td></tr> <tr><td>HD061814</td><td>R1/8</td><td>G1/4</td><td>17</td></tr> <tr><td>HD061838</td><td>R1/8</td><td>G3/8</td><td>22</td></tr> <tr><td>HD061414</td><td>R1/4</td><td>G1/4</td><td>17</td></tr> <tr><td>HD061438</td><td>R1/4</td><td>G3/8</td><td>22</td></tr> <tr><td>HD061412</td><td>R1/4</td><td>G1/2</td><td>24</td></tr> <tr><td>HD063838</td><td>R3/8</td><td>G3/8</td><td>22</td></tr> <tr><td>HD063812</td><td>R3/8</td><td>G1/2</td><td>24</td></tr> <tr><td>HD061212</td><td>R1/2</td><td>G1/2</td><td>26</td></tr> <tr><td>HD061234</td><td>R1/2</td><td>G3/4</td><td>32</td></tr> </tbody> </table>		connection M	connection F	key	HD061818	R1/8	G1/8	14	HD061814	R1/8	G1/4	17	HD061838	R1/8	G3/8	22	HD061414	R1/4	G1/4	17	HD061438	R1/4	G3/8	22	HD061412	R1/4	G1/2	24	HD063838	R3/8	G3/8	22	HD063812	R3/8	G1/2	24	HD061212	R1/2	G1/2	26	HD061234	R1/2	G3/4	32													
	connection M	connection F	key																																																																																																																																				
HD041814	R1/4	G1/8	14																																																																																																																																				
HD041838	R3/8	G1/8	17																																																																																																																																				
HD041812	R1/2	G1/8	22																																																																																																																																				
HD041438	R3/8	G1/4	17																																																																																																																																				
HD041412	R1/2	G1/4	22																																																																																																																																				
HD043812	R1/2	G3/8	22																																																																																																																																				
HD043834	R3/4	G3/8	27																																																																																																																																				
HD041234	R3/4	G1/2	27																																																																																																																																				
	connection M	connection F	key																																																																																																																																				
HD05M518	G1/8	M5	14																																																																																																																																				
HD051814	G1/4	G1/8	17																																																																																																																																				
HD051838	G3/8	G1/8	19																																																																																																																																				
HD051812	G1/2	G1/8	24																																																																																																																																				
HD051438	G3/8	G1/4	19																																																																																																																																				
HD051412	G1/2	G1/4	24																																																																																																																																				
HD053812	G1/2	G3/8	24																																																																																																																																				
HD053834	G3/4	G3/8	30																																																																																																																																				
HD051234	G3/4	G1/2	30																																																																																																																																				
	connection M	connection F	key																																																																																																																																				
HD061818	R1/8	G1/8	14																																																																																																																																				
HD061814	R1/8	G1/4	17																																																																																																																																				
HD061838	R1/8	G3/8	22																																																																																																																																				
HD061414	R1/4	G1/4	17																																																																																																																																				
HD061438	R1/4	G3/8	22																																																																																																																																				
HD061412	R1/4	G1/2	24																																																																																																																																				
HD063838	R3/8	G3/8	22																																																																																																																																				
HD063812	R3/8	G1/2	24																																																																																																																																				
HD061212	R1/2	G1/2	26																																																																																																																																				
HD061234	R1/2	G3/4	32																																																																																																																																				
<p>■ HD07 Extension M-F parallel thread</p>  <table border="1"> <thead> <tr> <th></th> <th>connection M</th> <th>connection F</th> <th>key</th> </tr> </thead> <tbody> <tr><td>HD07M518</td><td>M5</td><td>G1/8</td><td>14</td></tr> <tr><td>HD071818</td><td>G1/8</td><td>G1/8</td><td>14</td></tr> <tr><td>HD071814</td><td>G1/8</td><td>G1/4</td><td>17</td></tr> <tr><td>HD071838</td><td>G1/8</td><td>G3/8</td><td>22</td></tr> <tr><td>HD071414</td><td>G1/4</td><td>G1/4</td><td>17</td></tr> <tr><td>HD071438</td><td>G1/4</td><td>G3/8</td><td>22</td></tr> <tr><td>HD071412</td><td>G1/4</td><td>G1/2</td><td>24</td></tr> <tr><td>HD073838</td><td>G3/8</td><td>G3/8</td><td>22</td></tr> <tr><td>HD073812</td><td>G3/8</td><td>G1/2</td><td>24</td></tr> <tr><td>HD071212</td><td>G1/2</td><td>G1/2</td><td>26</td></tr> </tbody> </table>		connection M	connection F	key	HD07M518	M5	G1/8	14	HD071818	G1/8	G1/8	14	HD071814	G1/8	G1/4	17	HD071838	G1/8	G3/8	22	HD071414	G1/4	G1/4	17	HD071438	G1/4	G3/8	22	HD071412	G1/4	G1/2	24	HD073838	G3/8	G3/8	22	HD073812	G3/8	G1/2	24	HD071212	G1/2	G1/2	26	<p>■ HD08 Extension M-F parallel thread</p>  <table border="1"> <thead> <tr> <th></th> <th>connection M-F</th> <th>key</th> </tr> </thead> <tbody> <tr><td>HD081822</td><td>G1/8</td><td>14</td></tr> <tr><td>HD081435</td><td>G1/4</td><td>17</td></tr> <tr><td>HD081451</td><td>G1/4</td><td>17</td></tr> <tr><td>HD081842</td><td>G1/8</td><td>14</td></tr> <tr><td>HD081851</td><td>G1/8</td><td>14</td></tr> </tbody> </table>		connection M-F	key	HD081822	G1/8	14	HD081435	G1/4	17	HD081451	G1/4	17	HD081842	G1/8	14	HD081851	G1/8	14	<p>■ HD09 Extension F-F</p>  <table border="1"> <thead> <tr> <th></th> <th>connection 1</th> <th>connection 2</th> <th>key</th> </tr> </thead> <tbody> <tr><td>HD091814</td><td>G1/8</td><td>G1/4</td><td>17</td></tr> <tr><td>HD091838</td><td>G1/8</td><td>G3/8</td><td>22</td></tr> <tr><td>HD091812</td><td>G1/8</td><td>G1/2</td><td>24</td></tr> <tr><td>HD091438</td><td>G1/4</td><td>G3/8</td><td>22</td></tr> <tr><td>HD091412</td><td>G1/4</td><td>G1/2</td><td>24</td></tr> <tr><td>HD093812</td><td>G3/8</td><td>G1/2</td><td>24</td></tr> <tr><td>HD091234</td><td>G1/2</td><td>G3/4</td><td>32</td></tr> </tbody> </table>		connection 1	connection 2	key	HD091814	G1/8	G1/4	17	HD091838	G1/8	G3/8	22	HD091812	G1/8	G1/2	24	HD091438	G1/4	G3/8	22	HD091412	G1/4	G1/2	24	HD093812	G3/8	G1/2	24	HD091234	G1/2	G3/4	32																																							
	connection M	connection F	key																																																																																																																																				
HD07M518	M5	G1/8	14																																																																																																																																				
HD071818	G1/8	G1/8	14																																																																																																																																				
HD071814	G1/8	G1/4	17																																																																																																																																				
HD071838	G1/8	G3/8	22																																																																																																																																				
HD071414	G1/4	G1/4	17																																																																																																																																				
HD071438	G1/4	G3/8	22																																																																																																																																				
HD071412	G1/4	G1/2	24																																																																																																																																				
HD073838	G3/8	G3/8	22																																																																																																																																				
HD073812	G3/8	G1/2	24																																																																																																																																				
HD071212	G1/2	G1/2	26																																																																																																																																				
	connection M-F	key																																																																																																																																					
HD081822	G1/8	14																																																																																																																																					
HD081435	G1/4	17																																																																																																																																					
HD081451	G1/4	17																																																																																																																																					
HD081842	G1/8	14																																																																																																																																					
HD081851	G1/8	14																																																																																																																																					
	connection 1	connection 2	key																																																																																																																																				
HD091814	G1/8	G1/4	17																																																																																																																																				
HD091838	G1/8	G3/8	22																																																																																																																																				
HD091812	G1/8	G1/2	24																																																																																																																																				
HD091438	G1/4	G3/8	22																																																																																																																																				
HD091412	G1/4	G1/2	24																																																																																																																																				
HD093812	G3/8	G1/2	24																																																																																																																																				
HD091234	G1/2	G3/4	32																																																																																																																																				
<p>■ HD10 Male plug with hexagon wrench head</p>  <table border="1"> <thead> <tr> <th></th> <th>connection</th> <th>key</th> </tr> </thead> <tbody> <tr><td>HD1000M5</td><td>M5</td><td>8</td></tr> <tr><td>HD100018</td><td>G1/8</td><td>14</td></tr> <tr><td>HD100014</td><td>G1/4</td><td>17</td></tr> <tr><td>HD100038</td><td>G3/8</td><td>19</td></tr> <tr><td>HD100012</td><td>G1/2</td><td>24</td></tr> <tr><td>HD100034</td><td>G3/4</td><td>30</td></tr> <tr><td>HD100001</td><td>G1</td><td>38</td></tr> </tbody> </table>		connection	key	HD1000M5	M5	8	HD100018	G1/8	14	HD100014	G1/4	17	HD100038	G3/8	19	HD100012	G1/2	24	HD100034	G3/4	30	HD100001	G1	38	<p>■ HD11 Male plug (taper thread) with allen head</p>  <table border="1"> <thead> <tr> <th></th> <th>connection</th> <th>key</th> </tr> </thead> <tbody> <tr><td>HD110018</td><td>R1/8</td><td>5</td></tr> <tr><td>HD110014</td><td>R1/4</td><td>6</td></tr> <tr><td>HD110038</td><td>R3/8</td><td>8</td></tr> <tr><td>HD110012</td><td>R1/2</td><td>10</td></tr> </tbody> </table>		connection	key	HD110018	R1/8	5	HD110014	R1/4	6	HD110038	R3/8	8	HD110012	R1/2	10	<p>■ HD12 Male plug with O-ring (allen head)</p>  <table border="1"> <thead> <tr> <th></th> <th>connection</th> <th>key</th> </tr> </thead> <tbody> <tr><td>HD1200M5</td><td>M5</td><td>2,5</td></tr> <tr><td>HD120018</td><td>G1/8</td><td>5</td></tr> <tr><td>HD120014</td><td>G1/4</td><td>6</td></tr> <tr><td>HD120038</td><td>G3/8</td><td>8</td></tr> <tr><td>HD120012</td><td>G1/2</td><td>10</td></tr> </tbody> </table>		connection	key	HD1200M5	M5	2,5	HD120018	G1/8	5	HD120014	G1/4	6	HD120038	G3/8	8	HD120012	G1/2	10																																																																												
	connection	key																																																																																																																																					
HD1000M5	M5	8																																																																																																																																					
HD100018	G1/8	14																																																																																																																																					
HD100014	G1/4	17																																																																																																																																					
HD100038	G3/8	19																																																																																																																																					
HD100012	G1/2	24																																																																																																																																					
HD100034	G3/4	30																																																																																																																																					
HD100001	G1	38																																																																																																																																					
	connection	key																																																																																																																																					
HD110018	R1/8	5																																																																																																																																					
HD110014	R1/4	6																																																																																																																																					
HD110038	R3/8	8																																																																																																																																					
HD110012	R1/2	10																																																																																																																																					
	connection	key																																																																																																																																					
HD1200M5	M5	2,5																																																																																																																																					
HD120018	G1/8	5																																																																																																																																					
HD120014	G1/4	6																																																																																																																																					
HD120038	G3/8	8																																																																																																																																					
HD120012	G1/2	10																																																																																																																																					
<p>■ HD13 Female plug</p>  <table border="1"> <thead> <tr> <th></th> <th>connection</th> <th>key</th> </tr> </thead> <tbody> <tr><td>HD130018</td><td>G1/8</td><td>14</td></tr> <tr><td>HD130014</td><td>G1/4</td><td>17</td></tr> <tr><td>HD130038</td><td>G3/8</td><td>20</td></tr> <tr><td>HD130012</td><td>G1/2</td><td>24</td></tr> </tbody> </table>		connection	key	HD130018	G1/8	14	HD130014	G1/4	17	HD130038	G3/8	20	HD130012	G1/2	24	<p>■ HD14 Elbow connector F-F</p>  <table border="1"> <thead> <tr> <th></th> <th>connection</th> <th>key</th> </tr> </thead> <tbody> <tr><td>HD1400M5</td><td>M5</td><td>8</td></tr> <tr><td>HD140018</td><td>G1/8</td><td>10</td></tr> <tr><td>HD140014</td><td>G1/4</td><td>13</td></tr> <tr><td>HD140038</td><td>G3/8</td><td>17</td></tr> <tr><td>HD140012</td><td>G1/2</td><td>21</td></tr> <tr><td>HD140034</td><td>G3/4</td><td>25</td></tr> <tr><td>HD140001</td><td>G1</td><td>30</td></tr> </tbody> </table>		connection	key	HD1400M5	M5	8	HD140018	G1/8	10	HD140014	G1/4	13	HD140038	G3/8	17	HD140012	G1/2	21	HD140034	G3/4	25	HD140001	G1	30	<p>■ HD15 Elbow connector M-F</p>  <table border="1"> <thead> <tr> <th></th> <th>connection 1</th> <th>connection 2</th> <th>key</th> </tr> </thead> <tbody> <tr><td>HD1500M5</td><td>M5</td><td>M5</td><td>9</td></tr> <tr><td>HD150018</td><td>R1/8</td><td>G1/8</td><td>10</td></tr> <tr><td>HD151814</td><td>R1/4</td><td>G1/8</td><td>10</td></tr> <tr><td>HD150014</td><td>R1/4</td><td>G1/4</td><td>13</td></tr> <tr><td>HD150038</td><td>R3/8</td><td>G3/8</td><td>17</td></tr> <tr><td>HD150012</td><td>R1/2</td><td>G1/2</td><td>21</td></tr> <tr><td>HD150034</td><td>R3/4</td><td>G3/4</td><td>25</td></tr> <tr><td>HD150001</td><td>R1</td><td>G1</td><td>30</td></tr> </tbody> </table>		connection 1	connection 2	key	HD1500M5	M5	M5	9	HD150018	R1/8	G1/8	10	HD151814	R1/4	G1/8	10	HD150014	R1/4	G1/4	13	HD150038	R3/8	G3/8	17	HD150012	R1/2	G1/2	21	HD150034	R3/4	G3/4	25	HD150001	R1	G1	30																																																										
	connection	key																																																																																																																																					
HD130018	G1/8	14																																																																																																																																					
HD130014	G1/4	17																																																																																																																																					
HD130038	G3/8	20																																																																																																																																					
HD130012	G1/2	24																																																																																																																																					
	connection	key																																																																																																																																					
HD1400M5	M5	8																																																																																																																																					
HD140018	G1/8	10																																																																																																																																					
HD140014	G1/4	13																																																																																																																																					
HD140038	G3/8	17																																																																																																																																					
HD140012	G1/2	21																																																																																																																																					
HD140034	G3/4	25																																																																																																																																					
HD140001	G1	30																																																																																																																																					
	connection 1	connection 2	key																																																																																																																																				
HD1500M5	M5	M5	9																																																																																																																																				
HD150018	R1/8	G1/8	10																																																																																																																																				
HD151814	R1/4	G1/8	10																																																																																																																																				
HD150014	R1/4	G1/4	13																																																																																																																																				
HD150038	R3/8	G3/8	17																																																																																																																																				
HD150012	R1/2	G1/2	21																																																																																																																																				
HD150034	R3/4	G3/4	25																																																																																																																																				
HD150001	R1	G1	30																																																																																																																																				

HD16
Elbow connector M-M (taper thread)

	connection 1	connection 2	key
HD1600M5	M5	M5	9
HD160018	R1/8	R1/8	10
HD161814	R1/8	R1/4	10
HD160014	R1/4	R1/4	13
HD160038	R3/8	R3/8	17
HD160012	R1/2	R1/2	21
HD160034	R3/4	R3/4	25
HD160001	R1	R1	30

HD17
Intermediate Tee F-F-F (parallel thread)

	connection	key
HD1700M5	M5	9
HD170018	G1/8	10
HD170014	G1/4	13
HD170038	G3/8	17
HD170012	G1/2	21
HD170034	G3/4	25
HD170001	G1	30

HD18
Central Tee M-F-F

	connection M	connection F	key
HD1800M5	M5	M5	9
HD180018	R1/8	G1/8	10
HD180014	R1/4	G1/4	13
HD180038	R3/8	G3/8	17
HD180012	R1/2	G1/2	21
HD180034	R3/4	G3/4	25
HD180001	R1	G1	30

HD19
Lateral Tee M-F-F

	connection M	connection F	key
HD1900M5	M5	M5	9
HD190018	R1/8	G1/8	10
HD190014	R1/4	G1/4	13
HD190038	R3/8	G3/8	17
HD190012	R1/2	G1/2	21
HD190034	R3/4	G3/4	25
HD190001	R1	G1	30

HD20
Intermediate Tee M-M-M (taper thread)

	connection	key
HD200018	R1/8	10
HD200014	R1/4	13
HD200038	R3/8	17
HD200012	R1/2	21
HD200034	R3/4	25
HD200001	R1	30

HD21
Lateral Tee M-F-M

	connection M	connection F	key
HD210018	R1/8	G1/8	10
HD210014	R1/4	G1/4	13
HD210038	R3/8	G3/8	17
HD210012	R1/2	G1/2	21
HD210034	R3/4	G3/4	25
HD210001	R1	G1	30

HD22
Cross F-F-F-F

	connection	key
HD220018	G1/8	10
HD220014	G1/4	13
HD220038	G3/8	17
HD220012	G1/2	21

HD24
Tube adaptor (parallel thread)

Ø	connection	key
HD2404M5	M5	8
HD240618	G1/8	14
HD240718	G1/8	14
HD240818	G1/8	14
HD240918	G1/8	14
HD241018	G1/8	14
HD240614	G1/4	17
HD240714	G1/4	17
HD240814	G1/4	17
HD240914	G1/4	17
HD241014	G1/4	17
HD241214	G1/4	17
HD240938	G3/8	19
HD241038	G3/8	19

HD24
Tube adaptor (parallel thread)

Ø	connection	key
HD241238	G3/8	19
HD241438	G3/8	19
HD241738	G3/8	19
HD241212	G1/2	24
HD241412	G1/2	24
HD241712	G1/2	24
HD242012	G1/2	30
HD242034	G3/4	30

HD25
Y connector F-F-F

	connection	key
HD250018	G1/8	10
HD250014	G1/4	13
HD250038	G3/8	17
HD250012	G1/2	21

HD26
Y connector M-F-F

	connection M	connection F	key
HD260018	R1/8	G1/8	13
HD260014	R1/4	G1/4	17
HD260038	R3/8	G3/8	20
HD260012	R1/2	G1/2	25

HD27
Threaded bulkhead connector

	connection	key
HD2700M5	M5	14
HD270018	G1/8	19
HD270014	G1/4	24
HD270038	G3/8	30
HD270012	G1/2	32

HD32
Female single banjo

	connection
HD3200M5	M5
HD320018	G1/8
HD320014	G1/4

HD33
Taper nipple - 3 pieces

	connection	key
HD330018	R1/8	15
HD330014	R1/4	19
HD330038	R3/8	22
HD330012	R1/2	27
HD330034	R3/4	36
HD330001	R1	46

HD34
Female nipple - 3 pieces

	connection	key
HD340018	G1/8	14
HD340014	G1/4	17
HD340038	G3/8	21
HD340012	G1/2	25

HD42
Single banjo bolt

	connection	key
HD4200M5	M5	8
HD420018	R1/8	14
HD420014	R1/4	17
HD420038	R3/8	19
HD420012	R1/2	24

Washer to be used
HD46 2 pcs

HD43
Double banjo bolt

	connection	key
HD430018	R1/8	14
HD430014	R1/4	17
HD430038	R3/8	19
HD430012	R1/2	24

Washer to be used
HD46 3 pcs

HD44
Triple banjo bolt

	connection	key
HD440018	R1/8	14
HD440014	R1/4	17

Washer to be used
HD46 4 pcs

■ HD45

Aluminium washer



	connection	thickness (mm)
HD4500M5	M5	1
HD450018	G1/8	1,5
HD450014	G1/4	1,5
HD450038	G3/8	1,5
HD450012	G1/2	1,5

■ HD46

Indented nylon washer



	connection	thickness (mm)
HD4600M5	M5	1
HD460018	G1/8	1,6
HD460014	G1/4	1,6
HD460038	G3/8	1,8
HD460012	G1/2	2

Accessories

■ HD23

Cross block F-F-F-F



	connection
HD230018	G1/8
HD230014	G1/4
HD230038	G3/8
HD230012	G1/2

■ HD30

Distribution manifold (single outlets)



	In	Out	nr.
HD301803	G1/4	G1/8	3
HD301804	G1/4	G1/8	4
HD301805	G1/4	G1/8	5
HD301806	G1/4	G1/8	6
HD301403	G3/8	G1/4	3
HD301404	G3/8	G1/4	4
HD301405	G3/8	G1/4	5
HD301406	G3/8	G1/4	6
HD303803	G1/2	G3/8	3
HD303804	G1/2	G3/8	4
HD303805	G1/2	G3/8	5
HD303806	G1/2	G3/8	6

■ HD31

Distributors manifold (double outlets)



	In	Out	nr.
HD311803	G1/4	G1/8	3+3
HD311804	G1/4	G1/8	4+4
HD311805	G1/4	G1/8	5+5
HD311403	G3/8	G1/4	3+3
HD311404	G3/8	G1/4	4+4
HD311405	G3/8	G1/4	5+5

■ HD40

Reservoir (Max pressure 10 bar)



HD400100	lt 1
HD400250	lt 2,5
HD400500	lt 5
HD400700	lt 7
HD401200	lt 12

■ HD410000A

Stainless steel AISI 301 bracket



■ HD410000B

Reservoir extension



■ AM50



■ AM51



■ AM52



■ AM53



■ AM54



■ AM5200



■ AM5220



■ AM55



AM series (p. 3.92/93)

CHARACTERISTICS

Temperature	-15 ÷ 80 °C
Fluid	compressed air, vacuum, liquid
Working pressure	-0,99 ÷ 10 bar
Max pressure	16 bar
Body	nickel-plated brass
Nut	nickel-plated brass
Seal	NBR
Application fields	pneumatic circuits
Recommended tube	polyamide PA 10.12, polyurethane Sh.A98, co-polyurethane Sh.55D

5
HGC03

Male straight taper thread



	Ø connection		Ø connection
HGC030418	4 - 2,7 R1/8	HGC030838	8 - 6 R3/8
HGC030518	5 - 3 R1/8	HGC031038	10 - 8 R3/8
HGC030618	6 - 4 R1/8	HGC031238	12 - 10 R3/8
HGC030818	8 - 6 R1/8	HGC030812	8 - 6 R1/2
HGC031018	10 - 8 R1/8	HGC031012	10 - 8 R1/2
HGC030614	6 - 4 R1/4	HGC031212	12 - 10 R1/2
HGC030814	8 - 6 R1/4	HGC031512	15 - 12,5 R1/2
HGC031014	10 - 8 R1/4		
HGC030638	6 - 4 R3/8		

HGC04

Male straight parallel thread with O-Ring



	Ø connection		Ø connection
HGC0404M5	4 - 2,7 M5	HGC041038	10 - 8 G3/8
HGC0405M5	5 - 3 M5	HGC041238	12 - 10 G3/8
HGC0406M5	6 - 4 M5	HGC041012	10 - 8 G1/2
HGC040418	4 - 2,7 G1/8	HGC041212	12 - 10 G1/2
HGC040618	6 - 4 G1/8		
HGC040818	8 - 6 G1/8		
HGC041018	10 - 8 G1/8		
HGC040614	6 - 4 G1/4		
HGC040814	8 - 6 G1/4		
HGC041014	10 - 8 G1/4		
HGC040838	8 - 6 G3/8		

HGC07

Female straight



	Ø connection
HGC070618	6 - 4 G1/8
HGC070818	8 - 6 G1/8
HGC070614	6 - 4 G1/4
HGC070814	8 - 6 G1/4
HGC071014	10 - 8 G1/4
HGC070838	8 - 6 G3/8
HGC071038	10 - 8 G3/8
HGC071238	12 - 10 G3/8

HGC08

Female elbow



	Ø connection
HGC080618	6 - 4 G1/8
HGC080614	6 - 4 G1/4
HGC080818	8 - 6 G1/8
HGC080814	8 - 6 G1/4
HGC080838	8 - 6 G3/8
HGC081014	10 - 8 G1/4
HGC081038	10 - 8 G3/8
HGC081238	12 - 10 G3/8

HGC09

Taper elbow connection male



	Ø connection
HGC090418	4 - 2,7 R1/8
HGC090518	5 - 3 R1/8
HGC090618	6 - 4 R1/8
HGC090818	8 - 6 R1/8
HGC091018	10 - 8 R1/8
HGC090614	6 - 4 R1/4
HGC090814	8 - 6 R1/4
HGC091014	10 - 8 R1/4
HGC090638	6 - 4 R3/8
HGC090838	8 - 6 R3/8
HGC091038	10 - 8 R3/8
HGC091238	12 - 10 R3/8
HGC090812	8 - 6 R1/2
HGC091012	10 - 8 R1/2
HGC091212	12 - 10 R1/2
HGC091512	15 - 12,5 R1/2

HGC10

Swivel elbow with OR



	Ø connection
HGC100618	6 - 4 G1/8
HGC100818	8 - 6 G1/8
HGC100614	6 - 4 G1/4
HGC100814	8 - 6 G1/4
HGC101014	10 - 8 G1/4
HGC100838	8 - 6 G3/8
HGC101038	10 - 8 G3/8
HGC101238	12 - 10 G3/8

HGC14

Male lateral Tee taper thread



	Ø connection
HGC140618	6 - 4 R1/8
HGC140614	6 - 4 R1/4
HGC140818	8 - 6 R1/8
HGC140814	8 - 6 R1/4
HGC140838	8 - 6 R3/8
HGC141014	10 - 8 R1/4
HGC141038	10 - 8 R3/8
HGC141012	10 - 8 R1/2
HGC141238	12 - 10 R3/8
HGC141212	12 - 10 R1/2
HGC141512	15 - 12,5 R1/2

HGC16

Male central Tee taper thread



	Ø connection
HGC160618	6 - 4 R1/8
HGC160614	6 - 4 R1/4
HGC160818	8 - 6 R1/8
HGC160814	8 - 6 R1/4
HGC160838	8 - 6 R3/8
HGC161014	10 - 8 R1/4
HGC161038	10 - 8 R3/8
HGC161012	10 - 8 R1/2
HGC161238	12 - 10 R3/8
HGC161212	12 - 10 R1/2
HGC161512	15 - 12,5 R1/2

HGC19

Intermediate straight



	Ø
HGC190600	6 - 4
HGC190800	8 - 6
HGC191000	10 - 8
HGC191200	12 - 10
HGC191500	15 - 12,5

HGC20

Intermediate elbow



	Ø
HGC200400	4 - 2,7
HGC200600	6 - 4
HGC200800	8 - 6
HGC201000	10 - 8
HGC201200	12 - 10
HGC201500	15 - 12,5

HGC21

Intermediate Tee



	Ø
HGC210400	4 - 2,7
HGC210600	6 - 4
HGC210800	8 - 6
HGC211000	10 - 8
HGC211200	12 - 10
HGC211500	15 - 12,5

■ HGC22

Intermediate cross



	Ø
HGC220600	6 - 4
HGC220800	8 - 6
HGC221000	10 - 8

■ HGC30

Nut



	Ø	thread
HGC300400	4 - 2	M7x0,75
HGC300600	6 - 4	M10x1
HGC300800	8 - 6	M12x1
HGC301000	10 - 8	M14x1
HGC301200	12 - 10	M16x1
HGC301500	15 - 12,5	M20x1

■ HGC33

Intermediate straight bulkhead connector



	Ø
HGC330610	6 - 4
HGC330812	8 - 6
HGC331014	10 - 8
HGC331216	12 - 10
HGC331520	15 - 12,5

■ HGC40

Single banjo







	Ø	connection
HGC4004M5	4 - 2	M5
HGC4005M5	5 - 3	M5
HGC4006M5	6 - 4	M5
HGC400618	6 - 4	G1/8
HGC400818	8 - 6	G1/8
HGC400614	6 - 4	G1/4
HGC400814	8 - 6	G1/4
HGC401014	10 - 8	G1/4
HGC400838	8 - 6	G3/8
HGC401038	10 - 8	G3/8

Bolt to be used:
HD42 - HD43 - HD44

CHARACTERISTICS

Temperature	-15 ÷ 80 °C
Fluid	compressed air, water, oil
Working pressure	130 bar (Ø4), 180 bar (Ø6), 150 bar (Ø8), 110 bar (Ø10), 75 bar (Ø12), 70 bar (Ø15)
Body	nickel-plated brass
Nut	nickel-plated brass
Seals	NBR
Application fields	pneumatic circuits
Recommended tube	copper alloy, brass, stainless steel, plastic (reinforcing core)

5

<p>HGO03 Male straight taper thread</p>  <table border="1"> <thead> <tr> <th></th> <th>Ø connection</th> </tr> </thead> <tbody> <tr><td>HGO030418</td><td>4 R1/8</td></tr> <tr><td>HGO030618</td><td>6 R1/8</td></tr> <tr><td>HGO030818</td><td>8 R1/8</td></tr> <tr><td>HGO030614</td><td>6 R1/4</td></tr> <tr><td>HGO030814</td><td>8 R1/4</td></tr> <tr><td>HGO031014</td><td>10 R1/4</td></tr> <tr><td>HGO030838</td><td>8 R3/8</td></tr> <tr><td>HGO031038</td><td>10 R3/8</td></tr> <tr><td>HGO031238</td><td>12 R3/8</td></tr> <tr><td>HGO031212</td><td>12 R1/2</td></tr> <tr><td>HGO031512</td><td>15 R1/2</td></tr> </tbody> </table>		Ø connection	HGO030418	4 R1/8	HGO030618	6 R1/8	HGO030818	8 R1/8	HGO030614	6 R1/4	HGO030814	8 R1/4	HGO031014	10 R1/4	HGO030838	8 R3/8	HGO031038	10 R3/8	HGO031238	12 R3/8	HGO031212	12 R1/2	HGO031512	15 R1/2	<p>HGO04 Male straight parallel thread</p>  <table border="1"> <thead> <tr> <th></th> <th>Ø connection</th> </tr> </thead> <tbody> <tr><td>HGO040418</td><td>4 G1/8</td></tr> <tr><td>HGO040618</td><td>6 G1/8</td></tr> <tr><td>HGO040818</td><td>8 G1/8</td></tr> <tr><td>HGO040614</td><td>6 G1/4</td></tr> <tr><td>HGO040814</td><td>8 G1/4</td></tr> <tr><td>HGO041014</td><td>10 G1/4</td></tr> <tr><td>HGO040838</td><td>8 G3/8</td></tr> <tr><td>HGO041038</td><td>10 G3/8</td></tr> </tbody> </table>		Ø connection	HGO040418	4 G1/8	HGO040618	6 G1/8	HGO040818	8 G1/8	HGO040614	6 G1/4	HGO040814	8 G1/4	HGO041014	10 G1/4	HGO040838	8 G3/8	HGO041038	10 G3/8	<p>HGO09 Male elbow taper thread</p>  <table border="1"> <thead> <tr> <th></th> <th>Ø connection</th> </tr> </thead> <tbody> <tr><td>HGO090418</td><td>4 R1/8</td></tr> <tr><td>HGO090618</td><td>6 R1/8</td></tr> <tr><td>HGO090818</td><td>8 R1/8</td></tr> <tr><td>HGO090614</td><td>6 R1/4</td></tr> <tr><td>HGO090814</td><td>8 R1/4</td></tr> <tr><td>HGO091014</td><td>10 R1/4</td></tr> <tr><td>HGO090838</td><td>8 R3/8</td></tr> <tr><td>HGO091038</td><td>10 R3/8</td></tr> <tr><td>HGO091238</td><td>12 R3/8</td></tr> <tr><td>HGO091212</td><td>12 R1/2</td></tr> <tr><td>HGO091512</td><td>15 R1/2</td></tr> </tbody> </table>		Ø connection	HGO090418	4 R1/8	HGO090618	6 R1/8	HGO090818	8 R1/8	HGO090614	6 R1/4	HGO090814	8 R1/4	HGO091014	10 R1/4	HGO090838	8 R3/8	HGO091038	10 R3/8	HGO091238	12 R3/8	HGO091212	12 R1/2	HGO091512	15 R1/2
	Ø connection																																																																			
HGO030418	4 R1/8																																																																			
HGO030618	6 R1/8																																																																			
HGO030818	8 R1/8																																																																			
HGO030614	6 R1/4																																																																			
HGO030814	8 R1/4																																																																			
HGO031014	10 R1/4																																																																			
HGO030838	8 R3/8																																																																			
HGO031038	10 R3/8																																																																			
HGO031238	12 R3/8																																																																			
HGO031212	12 R1/2																																																																			
HGO031512	15 R1/2																																																																			
	Ø connection																																																																			
HGO040418	4 G1/8																																																																			
HGO040618	6 G1/8																																																																			
HGO040818	8 G1/8																																																																			
HGO040614	6 G1/4																																																																			
HGO040814	8 G1/4																																																																			
HGO041014	10 G1/4																																																																			
HGO040838	8 G3/8																																																																			
HGO041038	10 G3/8																																																																			
	Ø connection																																																																			
HGO090418	4 R1/8																																																																			
HGO090618	6 R1/8																																																																			
HGO090818	8 R1/8																																																																			
HGO090614	6 R1/4																																																																			
HGO090814	8 R1/4																																																																			
HGO091014	10 R1/4																																																																			
HGO090838	8 R3/8																																																																			
HGO091038	10 R3/8																																																																			
HGO091238	12 R3/8																																																																			
HGO091212	12 R1/2																																																																			
HGO091512	15 R1/2																																																																			
<p>HGO14 Male lateral Tee</p>  <table border="1"> <thead> <tr> <th></th> <th>Ø connection</th> </tr> </thead> <tbody> <tr><td>HGO140418</td><td>4 R1/8</td></tr> <tr><td>HGO140618</td><td>6 R1/8</td></tr> <tr><td>HGO140818</td><td>8 R1/8</td></tr> <tr><td>HGO140614</td><td>6 R1/4</td></tr> <tr><td>HGO140814</td><td>8 R1/4</td></tr> <tr><td>HGO141014</td><td>10 R1/4</td></tr> <tr><td>HGO141038</td><td>10 R3/8</td></tr> <tr><td>HGO141238</td><td>12 R3/8</td></tr> <tr><td>HGO141212</td><td>12 R1/2</td></tr> </tbody> </table>		Ø connection	HGO140418	4 R1/8	HGO140618	6 R1/8	HGO140818	8 R1/8	HGO140614	6 R1/4	HGO140814	8 R1/4	HGO141014	10 R1/4	HGO141038	10 R3/8	HGO141238	12 R3/8	HGO141212	12 R1/2	<p>HGO16 Male central Tee taper thread</p>  <table border="1"> <thead> <tr> <th></th> <th>Ø connection</th> <th>Ø connection</th> </tr> </thead> <tbody> <tr><td>HGO160418</td><td>4 R1/8</td><td>HGO161014</td><td>10 R1/4</td></tr> <tr><td>HGO160618</td><td>6 R1/8</td><td>HGO161038</td><td>10 R3/8</td></tr> <tr><td>HGO160818</td><td>8 R1/8</td><td>HGO161238</td><td>12 R3/8</td></tr> <tr><td>HGO160614</td><td>6 R1/4</td><td>HGO161212</td><td>12 R1/2</td></tr> <tr><td>HGO160814</td><td>8 R1/4</td><td>HGO161512</td><td>15 R1/2</td></tr> </tbody> </table>		Ø connection	Ø connection	HGO160418	4 R1/8	HGO161014	10 R1/4	HGO160618	6 R1/8	HGO161038	10 R3/8	HGO160818	8 R1/8	HGO161238	12 R3/8	HGO160614	6 R1/4	HGO161212	12 R1/2	HGO160814	8 R1/4	HGO161512	15 R1/2	<p>HGO19 Intermediate straight</p>  <table border="1"> <thead> <tr> <th></th> <th>Ø</th> </tr> </thead> <tbody> <tr><td>HGO190400</td><td>4</td></tr> <tr><td>HGO190600</td><td>6</td></tr> <tr><td>HGO190800</td><td>8</td></tr> <tr><td>HGO191000</td><td>10</td></tr> <tr><td>HGO191200</td><td>12</td></tr> <tr><td>HGO191500</td><td>15</td></tr> </tbody> </table>		Ø	HGO190400	4	HGO190600	6	HGO190800	8	HGO191000	10	HGO191200	12	HGO191500	15									
	Ø connection																																																																			
HGO140418	4 R1/8																																																																			
HGO140618	6 R1/8																																																																			
HGO140818	8 R1/8																																																																			
HGO140614	6 R1/4																																																																			
HGO140814	8 R1/4																																																																			
HGO141014	10 R1/4																																																																			
HGO141038	10 R3/8																																																																			
HGO141238	12 R3/8																																																																			
HGO141212	12 R1/2																																																																			
	Ø connection	Ø connection																																																																		
HGO160418	4 R1/8	HGO161014	10 R1/4																																																																	
HGO160618	6 R1/8	HGO161038	10 R3/8																																																																	
HGO160818	8 R1/8	HGO161238	12 R3/8																																																																	
HGO160614	6 R1/4	HGO161212	12 R1/2																																																																	
HGO160814	8 R1/4	HGO161512	15 R1/2																																																																	
	Ø																																																																			
HGO190400	4																																																																			
HGO190600	6																																																																			
HGO190800	8																																																																			
HGO191000	10																																																																			
HGO191200	12																																																																			
HGO191500	15																																																																			
<p>HGO20 Intermediate elbow</p>  <table border="1"> <thead> <tr> <th></th> <th>Ø</th> </tr> </thead> <tbody> <tr><td>HGO200400</td><td>4</td></tr> <tr><td>HGO200600</td><td>6</td></tr> <tr><td>HGO200800</td><td>8</td></tr> <tr><td>HGO201000</td><td>10</td></tr> <tr><td>HGO201200</td><td>12</td></tr> </tbody> </table>		Ø	HGO200400	4	HGO200600	6	HGO200800	8	HGO201000	10	HGO201200	12	<p>HGO21 Intermediate Tee</p>  <table border="1"> <thead> <tr> <th></th> <th>Ø</th> </tr> </thead> <tbody> <tr><td>HGO210400</td><td>4</td></tr> <tr><td>HGO210600</td><td>6</td></tr> <tr><td>HGO210800</td><td>8</td></tr> <tr><td>HGO211000</td><td>10</td></tr> <tr><td>HGO211200</td><td>12</td></tr> <tr><td>HGO211500</td><td>15</td></tr> </tbody> </table>		Ø	HGO210400	4	HGO210600	6	HGO210800	8	HGO211000	10	HGO211200	12	HGO211500	15	<p>HGO30 Nut</p>  <table border="1"> <thead> <tr> <th></th> <th>Ø</th> <th>thread</th> <th>key</th> </tr> </thead> <tbody> <tr><td>HGO300400</td><td>4</td><td>8x1</td><td>10</td></tr> <tr><td>HGO300600</td><td>6</td><td>10x1</td><td>12</td></tr> <tr><td>HGO300800</td><td>8</td><td>12x1</td><td>14</td></tr> <tr><td>HGO301000</td><td>10</td><td>16x1</td><td>19</td></tr> <tr><td>HGO301200</td><td>12</td><td>18x1</td><td>22</td></tr> <tr><td>HGO301500</td><td>15</td><td>30x1</td><td>27</td></tr> </tbody> </table>		Ø	thread	key	HGO300400	4	8x1	10	HGO300600	6	10x1	12	HGO300800	8	12x1	14	HGO301000	10	16x1	19	HGO301200	12	18x1	22	HGO301500	15	30x1	27												
	Ø																																																																			
HGO200400	4																																																																			
HGO200600	6																																																																			
HGO200800	8																																																																			
HGO201000	10																																																																			
HGO201200	12																																																																			
	Ø																																																																			
HGO210400	4																																																																			
HGO210600	6																																																																			
HGO210800	8																																																																			
HGO211000	10																																																																			
HGO211200	12																																																																			
HGO211500	15																																																																			
	Ø	thread	key																																																																	
HGO300400	4	8x1	10																																																																	
HGO300600	6	10x1	12																																																																	
HGO300800	8	12x1	14																																																																	
HGO301000	10	16x1	19																																																																	
HGO301200	12	18x1	22																																																																	
HGO301500	15	30x1	27																																																																	
<p>HGO31 Olive</p>  <table border="1"> <thead> <tr> <th></th> <th>Ø</th> </tr> </thead> <tbody> <tr><td>HGO310400</td><td>4</td></tr> <tr><td>HGO310600</td><td>6</td></tr> <tr><td>HGO310800</td><td>8</td></tr> <tr><td>HGO311000</td><td>10</td></tr> <tr><td>HGO311200</td><td>12</td></tr> <tr><td>HGO311500</td><td>15</td></tr> </tbody> </table>		Ø	HGO310400	4	HGO310600	6	HGO310800	8	HGO311000	10	HGO311200	12	HGO311500	15	<p>HGO32 Reinforcing core</p>  <table border="1"> <thead> <tr> <th></th> <th>Ø1</th> </tr> </thead> <tbody> <tr><td>HGO320600</td><td>4</td></tr> <tr><td>HGO320800</td><td>6</td></tr> <tr><td>HGO321000</td><td>8</td></tr> <tr><td>HGO321200</td><td>10</td></tr> <tr><td>HGO321500</td><td>12,5</td></tr> </tbody> </table>		Ø1	HGO320600	4	HGO320800	6	HGO321000	8	HGO321200	10	HGO321500	12,5	<p>HGO33 Bulkhead connector</p>  <table border="1"> <thead> <tr> <th></th> <th>Ø</th> </tr> </thead> <tbody> <tr><td>HGO330600</td><td>6</td></tr> <tr><td>HGO330800</td><td>8</td></tr> <tr><td>HGO331000</td><td>10</td></tr> <tr><td>HGO331200</td><td>12</td></tr> </tbody> </table>		Ø	HGO330600	6	HGO330800	8	HGO331000	10	HGO331200	12	<p>HGO40 Single banjo</p>  <table border="1"> <thead> <tr> <th></th> <th>Ø connection</th> </tr> </thead> <tbody> <tr><td>HGO400618</td><td>6 G1/8</td></tr> <tr><td>HGO400818</td><td>8 G1/8</td></tr> <tr><td>HGO400614</td><td>6 G1/4</td></tr> <tr><td>HGO400814</td><td>8 G1/4</td></tr> </tbody> </table> <p>Bolt to be used: HD42 - HD43 - HD44</p>		Ø connection	HGO400618	6 G1/8	HGO400818	8 G1/8	HGO400614	6 G1/4	HGO400814	8 G1/4																			
	Ø																																																																			
HGO310400	4																																																																			
HGO310600	6																																																																			
HGO310800	8																																																																			
HGO311000	10																																																																			
HGO311200	12																																																																			
HGO311500	15																																																																			
	Ø1																																																																			
HGO320600	4																																																																			
HGO320800	6																																																																			
HGO321000	8																																																																			
HGO321200	10																																																																			
HGO321500	12,5																																																																			
	Ø																																																																			
HGO330600	6																																																																			
HGO330800	8																																																																			
HGO331000	10																																																																			
HGO331200	12																																																																			
	Ø connection																																																																			
HGO400618	6 G1/8																																																																			
HGO400818	8 G1/8																																																																			
HGO400614	6 G1/4																																																																			
HGO400814	8 G1/4																																																																			

CHARACTERISTICS

Temperature	-10 ÷ 80 °C
Fluid	compressed air
Max working pressure	12 bar
Body	nickel-plated brass, zinc-plated steel
Ferrule	nickel-plated brass, zinc-plated steel
Seals	NBR
Spring	nickel-plated brass, zinc-plated steel

<p>■ HGU2001M Universal male socket</p>  <p>connection</p> <p>HGU2001M14 G1/4 HGU2001M38 G3/8 HGU2001M12 G1/2</p>	<p>■ HGU2001F Universal female socket</p>  <p>connection</p> <p>HGU2001F14 G1/4 HGU2001F38 G3/8 HGU2001F12 G1/2</p>	<p>■ HGU2002M Universal male plug</p>  <p>connection</p> <p>HGU2002M14 G1/4 HGU2002M38 G3/8</p>
<p>■ HGU2002F Universal female plug</p>  <p>connection</p> <p>HGU2002F14 G1/4 HGU2002F38 G3/8</p>	<p>■ HGU1001M Male mini socket</p>  <p>connection</p> <p>HGU1001M18 G1/8 HGU1001M14 G1/4</p>	<p>■ HGU1001F Female mini socket</p>  <p>connection</p> <p>HGU1001F18 G1/8 HGU1001F14 G1/4</p>
<p>■ HGU1002M Male mini plug</p>  <p>connection</p> <p>HGU1002M18 G1/8 HGU1002M14 G1/4</p>	<p>■ HGU1002F Female mini plug</p>  <p>connection</p> <p>HGU1002F18 G1/8 HGU1002F14 G1/4</p>	

For further technical information contact our Sales Office

HE

HEA

 Polyamide tubes PA10.12
Colors: neutral, black, blue, sky-blue

Part No.	Tube		
	Ø E	Ø I	R
HEA0420...	4	2	15
HEA0425...	4	2,5	20
HEA0604...	6	4	35
HEA0806...	8	6	40
HEA1008...	10	8	60
HEA1210...	12	10	85
HEA1412...	14	12	90

HEC

 Polyurethane tubes Sh. A98
Colors: neutral, black, sky-blue

Part No.	Tube		
	Ø E	Ø I	R
HEC0420...	4	2	15
HEC0604...	6	4	20
HEC0806...	8	6	25
HEC1008...	10	8	35
HEC1209...	12	9	45

HED

 Co-polyurethane tubes Sh. 55D
Colors: neutral, black, blue, sky-blue

Part No.	Tube		
	Ø E	Ø I	R
HED0420...	4	2,5	10
HED0604...	6	4	15
HED0806...	8	6	25
HED1008...	10	8	35
HED1209...	12	9	45

Ø E = External diameter (mm) Ø I = Internal diameter (mm) R = Bending radius (mm)

For color options, add the following suffixes to part no.:
NEU = Neutral **NER** = Black **BLU** = Blue **AZZ** = Sky-blue (example HEA0420NEU)

Min. package: 100 m coil
HF
HFA Rilsan® Spiral tubes

 Polyamide Spiral Tubes PA10.12
Colors: neutral, blue, sky-blue, orange

HFA121015... and HFA121030...
available only blue and orange

Part No.	Tube			Spiral		
	Ø E	Ø I	Linear (mt)	Rest (mm)	Max Length (mt)	Ø I (mm)
HFA042010...	4	2	10	360	6	30
HFA042015...	4	2	15	550	9	30
HFA060415...	6	4	15	430	9	60
HFA060430...	6	4	30	870	17	60
HFA080615...	8	6	15	455	9	80
HFA080630...	8	6	30	910	17	80
HFA100815...	10	8	15	490	9	90
HFA100830...	10	8	30	990	17	90
HFA121015...	12	10	15	430	9	120
HFA121030...	12	10	30	870	17	120

HFC Elastollan® Spiral tubes with straight ends

 Polyurethane Spiral Tubes (Sh.A98) with ends parallelling the spiral axis
Colors: neutral, sky-blue

Part No.	Tube			Spiral		
	Ø E	Ø I	Linear (mt)	Rest (mm)	Max Length (mt)	Ø I (mm)
HFC64C06...	6	4	6	380	4	25
HFC64C12...	6	4	12	760	8	25
HFC855C06...	8	5,5	6	310	4	40
HFC855C12...	8	5,5	12	640	8	40
HFC107C06...	10	7	6	330	4	50
HFC107C12...	10	7	12	680	8	50
HFC128C06	12	8	6	320	4	60
HFC128C12...	12	8	12	660	8	60

Ø E = External diameter (mm) Ø I = Internal diameter (mm) End length 150 mm

For color options, add the following suffixes to part no.:
NEU = Neutral **BLU** = Blue **AZZ** = Sky-blue **ARA** = Orange

HD28

Tube cutter



	Tube
HD280012	2÷12
HD280025	12÷25

DF



Type	ELECTROMECHANICAL			ELECTRONIC
	DF-220	DF-330	DF-440	PNP
Part No.				DF-770
Working voltage (V AC/DC)	5÷30 V AC/DC	5÷30 V AC/DC	5÷30 V AC/DC	5÷30 V DC
Max switching voltage (mA)	100	100	100	100
Max switching power (W/VA)	3	3	3	3
Max voltage drop (V AC/DC)	<3,5	0,1	0,1	0,7
Minimum magnetic field (gauss)	60	60	60	30
Opening response time (ms)	< 0,5	< 0,5	< 0,5	0,08
Closing response time (ms)	< 1	< 1	< 1	0,03
Electric life with resistive load (cycles)	>10 ⁷	>10 ⁷	>10 ⁷	>10 ⁹
State indicator (LED)	red	red	red	red
Cable number and section (mmq)	2x0,14	3x0,14	3x0,14	3x0,14
Cable length (mm)	3000	3000	3000	3000
Electric circuit	A	C	D	C
Protection degree (EN60529)	IP67			
Working temperature (°C)	-20 ÷ +80			

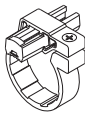
Other available versions (M08-M12)

- DF-220M08 DF-220M12
- DF-330M08 DF-330M12
- DF-440M08 DF-440M12
- DF-770M08 DF-770M12

Cable extensions

- DHF-033 M08 = 3 m M08
- DHF-033 M12 = 3 m M12
- DHF-053 M08 = 5 m M08
- DHF-053 M12 = 5 m M12

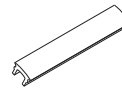
■ Fixing elements



DH-M10DF DH-M20DF
DH-M12DF DH-M25DF
DH-M16DF
Fixing bracket for M series cylinders



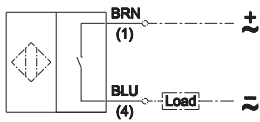
DF-001
Cable clamping



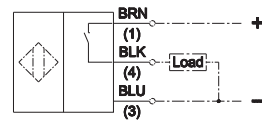
DHF-0020100
Covering strip

■ Electrical Circuit

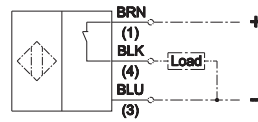
A AC/DC 2 wires NO



C DC 3 wires PNP NO



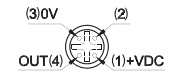
D DC 3 wires PNP NC



■ M08

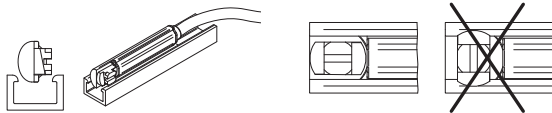


■ M12



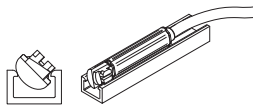
ASSEMBLY SCHEME

1



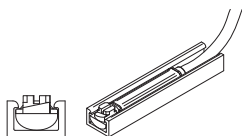
Put the sensor in the proper groove and make sure that the fastening plate has the slot for screwdriver along the sensor axis.

2



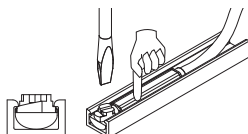
Put the sensor inside its groove and make sure that the fastening plate is on the open part of the groove.

3



Check the correct position of the sensor in the groove. Turn it to the wished position for detection.

4



Keep the sensor in its position and screw the fastening plate to fix the sensor in the groove.
Max torque: 0,5 ÷ 1 Nm

DH



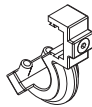
Other available versions (M08-M12)
 DH-200M08 DH-200M12
 DH-500M08 DH-500M12
 DH-700M08 DH-700M12

Cable extensions
 DHF-033 M08 = 3 m M08
 DHF-033 M12 = 3 m M12
 DHF-053 M08 = 5 m M08
 DHF-053 M12 = 5 m M12

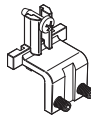
■ Fixing elements



DH-M10 DH-M20
DH-M12 DH-M25
DH-M16
 Fixing bracket for M series cylinders



DH-K032050
DH-K063125
DH-K160200
 Fixing bracket for KE-K-KL series cylinders



KM-032050-1
KM-063100-1
KM-125000-1
 Fixing bracket for KM sensors on ISO cylinders (upon request)



DH-S25
DH-S32
DH-S40
DH-S50
 Fixing bracket for S1 series rodless cylinders

Type	ELECTROMECHANICAL			ELECTRONIC PNP
	Part No.	KM-032000	DH-200	DH-500
Working voltage (V AC/DC)	5÷250 V AC/DC	5÷250 V AC/DC	5÷250 V AC/DC	10÷30 V DC
Max switching voltage (mA)	1000	200	200	100
Max switching power (W/VA)	30	10	10	5
Max voltage drop (V AC/DC)	< 3,5	< 3,5	< 3,5	0,7
Minimum magnetic field (gauss)	85	85	60	30
Opening response time (ms)	< 0,5	< 0,5	< 0,5	0,08
Closing response time (ms)	< 1	< 1	< 1	0,03
Electric life with resistive load (cycles)	>10 ⁷	>10 ⁷	>10 ⁷	>10 ⁹
State indicator (LED)	red	red	red	red
Cable number and section (mmq)	2x0,25	2x0,25	2x0,25	3x0,25
Cable length (mm)	3000	3000	3000	3000
Electric circuit	A	A	A	C
Protection degree (EN60529)	IP65			
Working temperature (°C)	-20 ÷ +80			

DF-R/DF-T

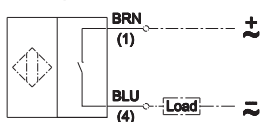


Type	ELECTROMECHANICAL		ELECTRONIC PNP	
	Part No.	DF-R200L02	DF-R200M08	DF-R700L02
Working voltage (V AC/DC)	5÷120 V AC/DC	5÷120 V AC/DC	5÷30 V DC	5÷30 V DC
Max switching voltage (mA)	100	100	50	50
Max switching power (W/VA)	10	10	1,5	1,5
Shock resistance (G)	30	30	50	50
Max voltage drop (V AC/DC)	2,5	2,5	1,5	1,5
Cable number and section (mmq)	2 x 2,8 (PUR)	2 x 2,8 (PUR)	3x3 (PUR)	3x3 (PUR)
Cable length (mm)	2000	150	2000	150
Contact	NO	NO	NO	NO
Max response time (ms)	1	1	1	1
State indicator (LED)	red	red	green	green
Electric circuit	A	-	C	-
Protection degree (NEMA 6)	IP67			
Working temperature (°C)	-10 ÷ +70			

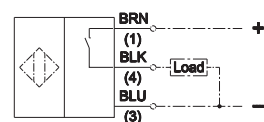
Type	ELECTROMECHANICAL		ELECTRONIC PNP	
	Part No.	DF-T200L03	DF-T200M08	DF-T700L03
Working voltage (V AC/DC)	5÷120 V AC/DC	5÷120 V AC/DC	5÷30 V DC	5÷30 V DC
Max switching voltage (mA)	100	100	200	200
Max switching power (W/VA)	10	10	6	6
Shock resistance (G)	30	30	50	50
Max voltage drop (V AC/DC)	2,5	2,5 V	1	1
Cable number and section (mmq)	2 x 2,8 (PUR)	2 x 2,8 (PUR)	3 x 2,8 (PUR)	3 x 2,8 (PUR)
Cable length (mm)	3000	150	3000	150
Contact	NO	NO	NO	NO
Max response time (ms)	1	1	1	1
Protection degree (NEMA 6)	red	red	green	green
Electric circuit	A	-	C	-
State indicator (LED)	IP67			
Working temperature (°C)	-10 ÷ +70			

■ Electrical Circuit

A AC/DC 2 wires NO



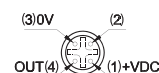
C DC 3 wires PNP NO



M8



M12



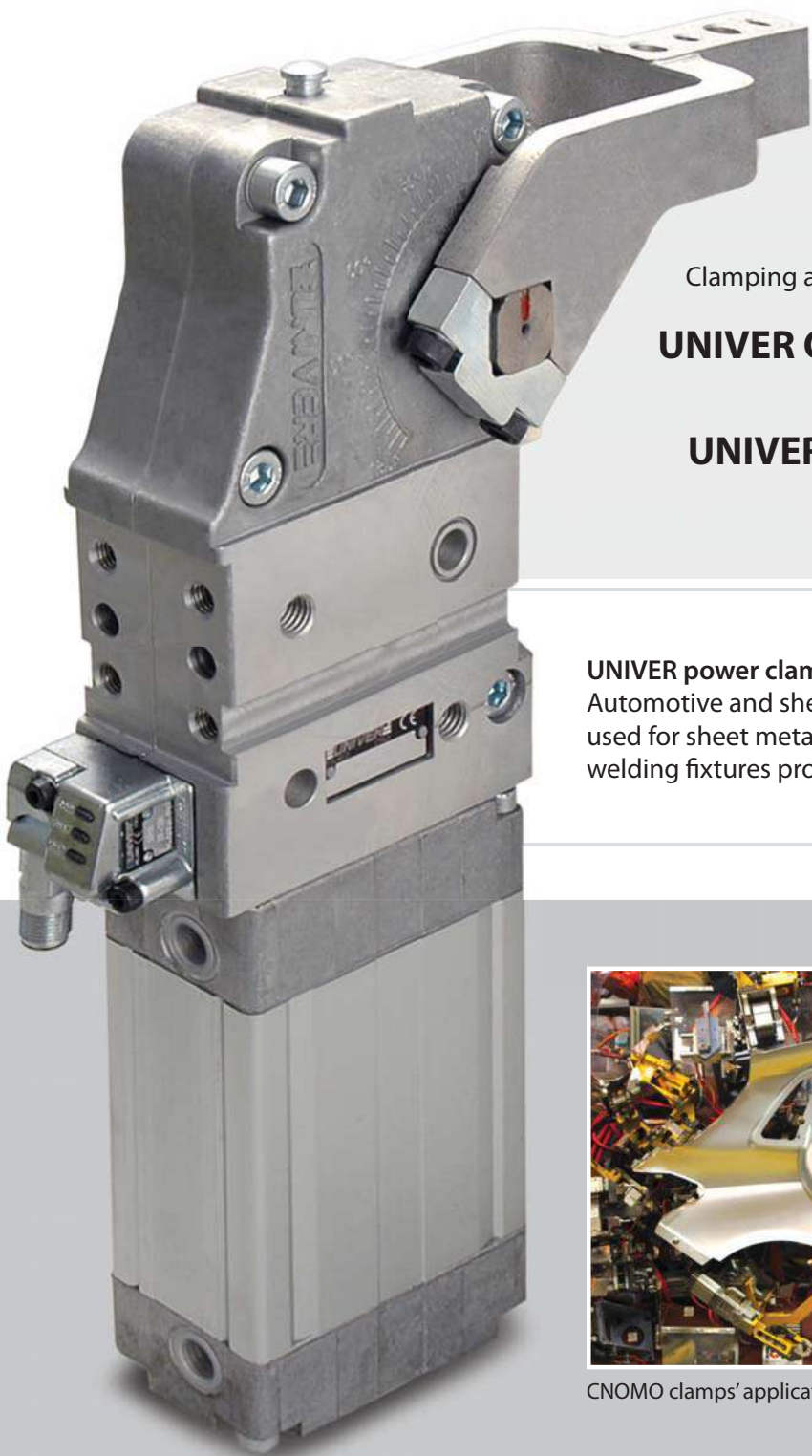
BRN = Brown BLK = Black BLU = Blue

6



Power Clamps

	Pneumatic Power clamps	UBP/UBH IBP/IBM UBS UDP UBM/UBQ UBT UFL/UHL UNP/UNM DMS	4/5
	Retractable locating pin units	LCP/LCM LCG LCZ/LCY LCT/LCX LCA/LCO LCL	5/6
	Pin clamps	LSP LTP LUP LSL	6
	Gripper units	UGP UGM LGP	7
	Power pivots	DMA LAGP	7
	Marking units	PRP	7
	Electrical units	LAE LNE LGE LCE LAGE	8
	Accessories	CLAMPING ARMS UBK UBF DF Electronic sensor	8



STEPLESS ADJUSTMENT

Opening angle adjustment 0 ÷ 135°

LIGHT-WEIGHT

Clamping arm and clamp housing in aluminium alloy

UNIVER ORIGINAL LINKAGE DESIGN

Ensures positional repeatability

UNIVER ORIGINAL METAL SENSOR

Metal case
M12 swivel connector

UNIVER power clamps meet the requirements of the Automotive and sheet metal industries; they are mostly used for sheet metal handling, BIW applications and welding fixtures production.



CNOMO clamps' applications





Pneumatic power clamps' applications



Electric power pivots' applications



Our customers

Pneumatic power clamps

UBP

UNIVERSAL Pneumatic power clamp

Ø32
NEW



Ø Cylinder mm: 32 - 40 - 50 - 63 - 80
Fully adjustable opening angle

UBH

UNIVERSAL Pneumatic power clamp



Ø Cylinder mm: 40 - 63
Fully adjustable opening angle

IBP

Pneumatic power clamp interchangeable with size 50/63 mm



Ø Cylinder mm: 40
Fully adjustable opening angle

UBS

Safety pneumatic power clamp



Ø Cylinder mm: 40
In case of emergency (= no air) the safety clamp closes automatically

UDP

Pneumatic power clamp with 2 arms



Ø Cylinder mm: 40
Fully adjustable opening angle



Ø Cylinder mm: 63
Fully adjustable opening angle

UBM

UNIVERSAL Pneumatic power clamp with handlever



Ø Cylinder mm: 40 - 50 - 63 - 80
Fully adjustable opening angle

IBM

Pneumatic power clamp with handlever interchangeable with size 50/63 mm



Ø Cylinder mm: 40
Fully adjustable opening angle

UBQ

Pneumatic power clamp with handlever



Ø Cylinder mm: 40 - 63
Fully adjustable opening angle

UBT

Pneumatic power clamp with central handlever



Ø Cylinder mm: 40
Fully-adjustable opening angle

UFL - UHL

Manual power clamps



Without pneumatic cylinders

Clamps conforming to the NAAMS and CNOMO standard

■ **UNP**

UNIVERSAL Pneumatic power clamps conforming to the N.A.A.M.S. Standard



Ø Cylinder mm: 50 - 63 - 80
Fully adjustable opening angle

■ **UNM**

UNIVERSAL Pneumatic power clamps with handlever conforming to the N.A.A.M.S. Standard



Ø Cylinder mm: 50 - 63
Fully adjustable opening angle

■ **DMS**

Pneumatic power clamps conforming to the CNOMO Standard



Ø Cylinder mm: 32 - 40 - 50 - 63
Fully adjustable opening angle

Retractable locating pin units, single and double rod

■ **LCP**

Pneumatic retractable locating pin units with single rod



LCP32
Ø Cylinder mm: 32
Stroke mm: 20 - 40



LCP50
Ø Cylinder mm: 50
Stroke mm: 15 - 25 - 40 - 50 - 60 - 75 - 100 - 110



LCP63
Ø Cylinder mm: 63
Versions: 15 - 25 - 40 - 50 - 60

■ **LCG**

Pneumatic retractable locating pin units, conforming to the CNOMO Standard, with single rod



Ø Cylinder mm: 50 - 63
Stroke mm: 25 - 50

■ **LCZ**

Pneumatic retractable locating pin units with single rod and toggle-joint mechanism



Ø Cylinder mm: 40
Stroke mm: 40

■ **LCJ**

Pneumatic retractable locating pin units, with improved pull force



Ø Cylinder mm: 50
Stroke mm: 25 - 40 - 60

NEW

■ **LCA**

Pneumatic retractable locating pin units with double rod



Ø Cylinder mm: 40
Stroke mm: 20 - 40



Ø Cylinder mm: 63
Stroke mm: 25 - 40 - 50 - 60

■ **LCT**

Pneumatic retractable locating pin units with double rod and toggle-joint mechanism



Ø Cylinder mm: 32 - 50
Stroke mm: 40

Retractable locating pin units with handlever

■ **LCM**

Pneumatic retractable locating pin unit with hand lever



Ø Cylinder mm: 50
Stroke mm: 25 - 40 - 50 - 60

■ **LCL**

Manual retractable locating pin unit



Stroke mm: 15 - 25 - 40 - 50 - 60
Without pneumatic cylinders

■ **LCO**

Pneumatic retractable locating pin unit with two rods and hand lever



Ø Cylinder mm: 50
Stroke mm: 40

■ **LCY**

Pneumatic retractable locating pin unit with hand lever and toggle-joint mechanism



Ø Cylinder mm: 40
Stroke mm: 40

■ **LCX**

Pneumatic retractable locating pin unit with two rods and hand lever and toggle-joint mechanism



Ø Cylinder mm: 50
Stroke mm: 40

Pneumatic pin clamps

■ **LSP**

Pneumatic pin clamp



Ø Cylinder mm: 32 - 50

■ **LSP50U**

Pneumatic pin clamp- horizontal shape



Ø Cylinder mm: 40

■ **LTP**

Pneumatic pin clamp with vanishing hook



Ø Cylinder mm: 50

■ **LUP**

Pneumatic pin clamp with vanishing hook and pin



Ø Cylinder mm: 63

■ **LSL**

Manual pin clamp



Multiple pin sizes available

Gripper units

- **UGP**
Pneumatic gripper units



Ø Cylinder mm: 40
Versions: single and double jaws movement
Fully adjustable opening angle

- **UGM**
Pneumatic gripper unit with hand lever



Ø Cylinder mm: 40
Versions: single and double jaws movement
Fully adjustable opening angle

- **LGP**
Pneumatic gripper



Ø Cylinder mm: 32 - 40
Versions: single and double jaws movement

NEW

Power pivots

- **DMA**
Pneumatic power pivots, CNOMO mounting



Ø Cylinder mm: 63
Fully adjustable opening angle

- **LAGP**
Pneumatic power pivots



Ø Cylinder mm: 63 - 80 - 100 - 125 - 160 - 200
Size: 63-75-80-120-155-150-170-210-300
350 - 600 - 605
Brake system

Marking unit

- **PRP**
Pneumatic marking unit



PRP025 - PRP050
Ø Cylinder mm: 63
Versions: single letter/number



PRP500
Ø Cylinder mm: 100
Versions: up to 7 letters/numbers marking
The marking head can be mounted on the lower mounting surface or on the upper moving arms



PRP1100
Ø Cylinder mm: 160
Versions: up to 8 letters/numbers marking
The marking head can be mounted on the lower mounting surface or on the upper moving arms

NEW

Electric unit with modular electronics

■ **LAE**
Electric power clamps



Size: 140 - 225 - 350 - 950
Adjustable opening angle
Built in "obstruction" detection

■ **LNE**
Electric power clamps, fixing conforming to the N.A.A.M.S. Standard



Size: 225 - 350
Adjustable opening angle
Built in "obstruction" detection

■ **LGE**
Electric gripper units



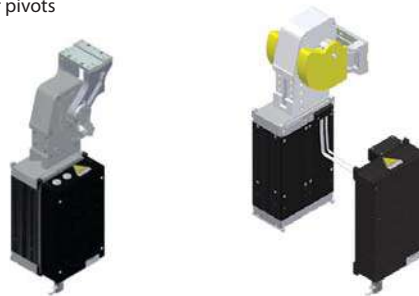
Size: 140
Adjustable opening angle
Built in "obstruction" detection

■ **LCE**
Electric retractable locating pin unit



Size: 350
Adjustable stroke

■ **LAGE**
Electric power pivots



Size: 500 - 1000
Control module can be mounted remotely
The Integrated brake maintains the position any time power is lost

Accessories

■ **Clamping arms**
Wishbone/Blade Arms conforming to the DIN or N.A.A.M.S. Standard



Offset mm: 0 - 15 - 25 - 45 - 50 - 70 - 75 - 105 - 120

■ **UBK**
Self-holding spring for open position



■ **UBF**
Ergonomic Handlevers



■ **DF Electronic sensor**



7

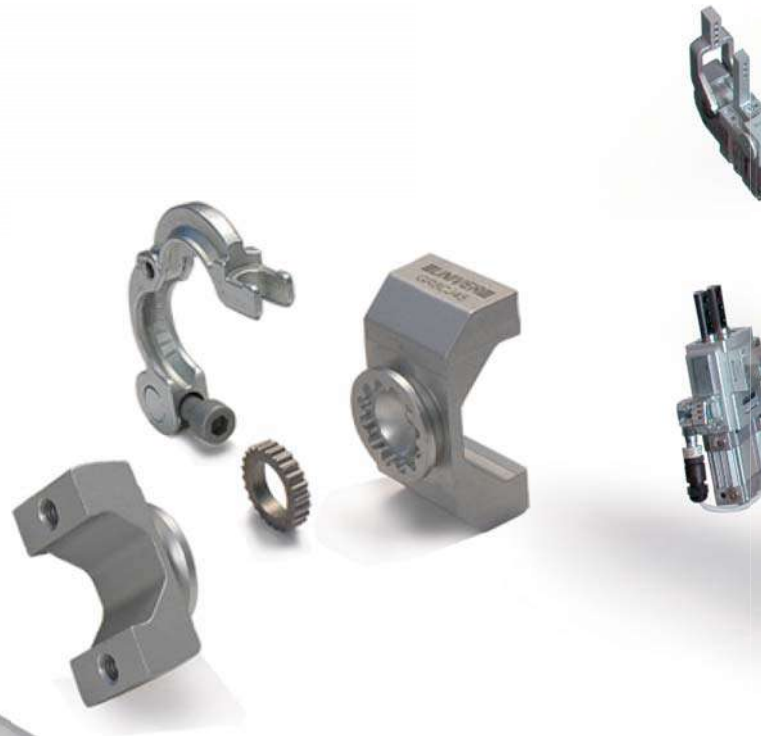
GR8 Tooling



Modular Tooling System GR8



GR8 Modular Tooling System



KIT

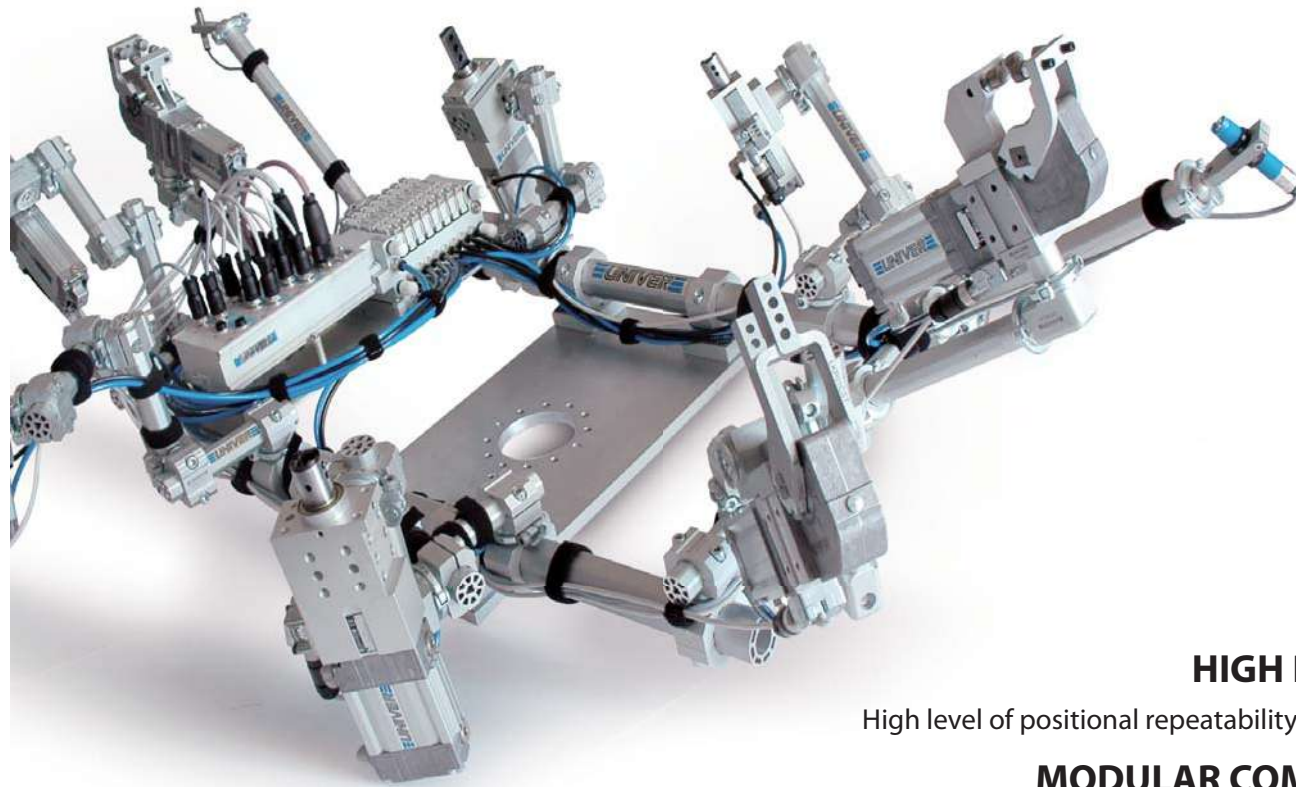
Considerable reduction of mounting elements

Ø 30 - 45 - 70 mm booms

Maximum stiffness and minimum weight



PATENT PENDING



HIGH PRECISION

High level of positional repeatability; low deflection

MODULAR COMPONENTS

Considerable reduction of mounting components

QUICK INSTALLATION AND SET UP

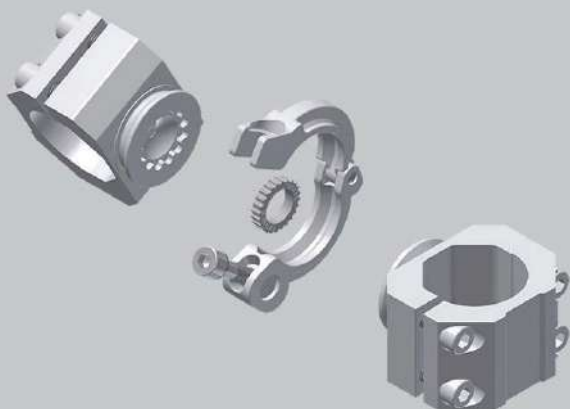
No welding or doweling required,
easily replaceable components

FULLY ADJUSTABLE

Unlimited orientation in space and free configuration

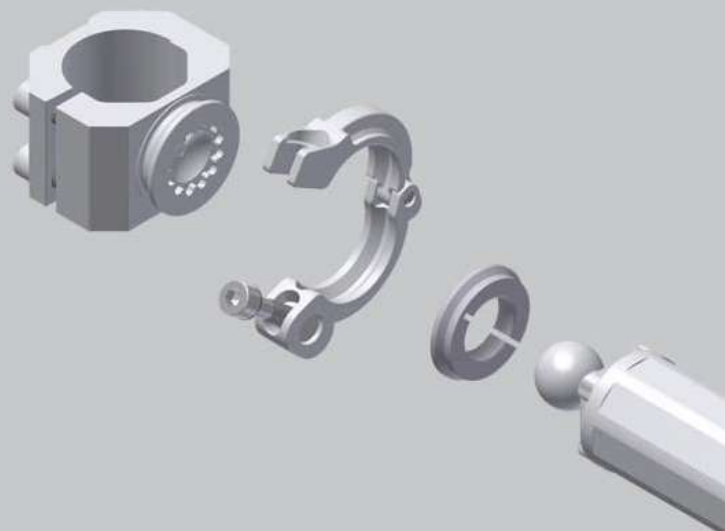
Locking ring






Precise and efficient system to guarantee a high level of positional accuracy



Ball mounting












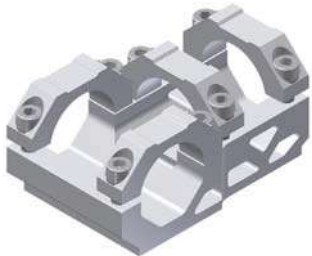
Unlimited swivel rotation

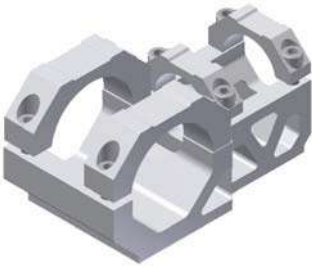
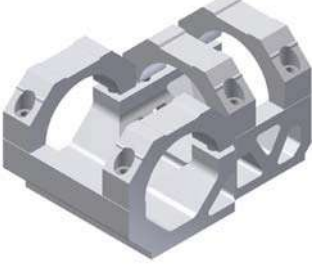




Booms			Inserts	Locking ring
<p>■ GR8B30S6000 Ø 30 mm Octagonal boom</p> 	<p>■ GR8B456000 Ø 45 mm Octagonal boom</p> 	<p>■ GR8B706000 Ø 70 mm Octagonal boom</p> 	<p>■ GR8IK Interlocking key insert</p> 	<p>■ GR8LHD Locking ring</p> 

7

Booms end caps		
<p>■ GR8C30 30 mm boom end cap</p> 	<p>■ GR8C45 45 mm boom end cap</p> 	<p>■ GR8C70 70 mm boom end cap</p> 

Mounts			
<p>■ GR8CJ30D Octagonal Joint 30</p> 	<p>■ GR8RJ30D Round Joint 30</p> 	<p>■ GR8CJ45D Octagonal Joint 45</p> 	<p>■ GR8RJ45D Round Joint 45</p> 
<p>■ GR8CJ70D Octagonal Joint 70</p> 	<p>■ GR8RJ70 Round Joint 70</p> 	<p>■ GR8HD4530V Cross Joint 45-30</p> 	<p>■ GR8HD4545V Cross Joint 45-45</p> 
<p>■ GR8HD7045 Cross Joint 70-45</p> 	<p>■ GR8HD7070 Cross Joint 70-70</p> 	<p>■ GR8CM4530 Coplanar Mount 45-30</p> 	<p>■ GR8CM4545 Coplanar Mount 45-45</p> 

<p>■ GR8CM7045 Coplanar Mount 70-45</p> 	<p>■ GR8CM7070 Coplanar Mount 70-70</p> 	<p>■ GR8SCI30D Interlocking adapter 30</p> 	<p>■ GR8ECI45D Interlocking adapter 45</p> 
--	--	--	---




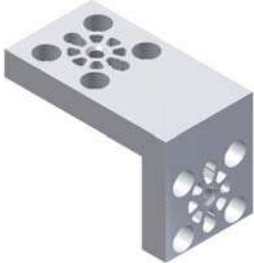












Angular Mounts

<p>■ GR8EOAD Orientable angle adapter</p> 	<p>■ GR8EOAD45 Orientable angle adapter</p> 	<p>■ GR8SM3030 Edge mounting element 30-30</p> 	<p>■ GR8SM4545 Edge mounting element 45-45</p> 
<p>■ GR8A30 Edge mount with an orientable side for 30 mm booms</p> 	<p>■ GR8A45 Edge mount with an orientable side for 45 booms</p> 	<p>■ GR8A3045 45° Mounting element male-female for 30 mm booms</p> 	<p>■ GR8SM3045 Mounting element for 30 mm booms</p> 

Base Mounts

<p>■ GR8BB30D Base plate bracket 30</p> 	<p>■ GR8BB45D Base plate bracket 45</p> 	<p>■ GR8BB70 Base plate bracket 70</p> 	<p>■ GR8BL45 Base linear plate 45</p> 
<p>■ GR8BC30 Base connector 30</p> 	<p>■ GR8BC45 Base connector 45</p> 	<p>■ GR8BC70 Base connector 70</p> 	<p>■ GR8BL70 Base linear plate 70</p> 

Mounting adapters

<p>■ GR8SR40 Rear mount plate for 40 clamps</p> 	<p>■ GR8SR50 Rear mount plate for retractable locating pin units LCP50</p> 	<p>■ GR8SR50M8 Rear mount plate with M8 threads</p> 	<p>■ GR8SS50 Side mount plate for retractable locating pin units LCP50</p> 
<p>■ GR8SR40D Mount plate for size 40 clamps</p> 	<p>■ GR8SR50D Rear mount plate for retractable locating pin units LCP50</p> 	<p>■ GR8SR50M8D Rear mount plate with M8 threads</p> 	<p>■ GR8SS50D Side mount plate for retractable locating pin units LCP50</p> 
<p>■ GR8MF40AD Interlocking adapter</p> 	<p>■ GR8MF40D Front mount plate for size 40 clamps</p> 	<p>■ GR8MF50D Front mount plate for size 50 clamps</p> 	<p>■ GR8MFGLD Front mount plate for UGP40VL</p> 
<p>■ GR8MP12D Proximity mount with 12 mm inner Ø</p> 	<p>■ GR8MP18D Proximity mount with 18 mm inner Ø</p> 	<p>■ GR8MP19D Vacuum cup adapter with 19 mm inner Ø</p> 	<p>■ GR8MP30D Proximity mount with 30 mm inner Ø</p> 

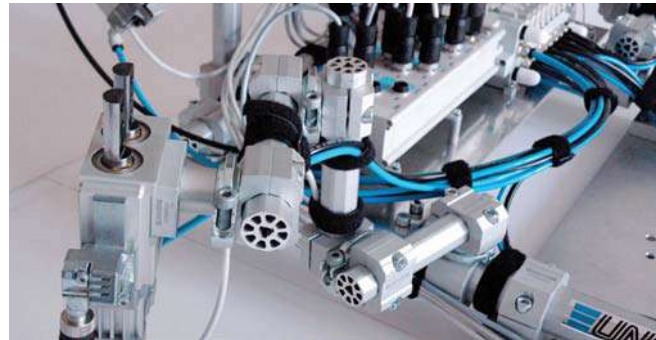
<p>■ GR8SCB30D Ball mount - 30</p> 	<p>■ GR8SCB45D Ball mount - 45</p> 
---	---

Mounts for LGP32-40

<p>■ GR8LGP32MO25 Orbital mount - 360° unlimited rotation - Ball Ø 25 mm</p> 	<p>■ GR8LGP32MO30 Orbital mount - 360° unlimited rotation - Ball Ø 30 mm</p> 	<p>■ GR8LGP32MP Middle flange mount Ø 32</p> 	<p>■ GR8LGP40MO25 Orbital mount - 360° unlimited rotation - Ball Ø 25 mm</p> 
<p>■ GR8LGP40MO30 Orbital mount - 360° unlimited rotation - Ball Ø 30 mm</p> 	<p>■ GR8LGP40MO45 Orbital mount - 360° unlimited rotation - Ball Ø 45 mm</p> 	<p>■ GR8LGP40MP Middle flange mount Ø 40</p> 	
<p>■ GR8LGP40AF Middle angular mount</p> 	<p>■ GR8LGP40A025 Ø 25 angular mount</p> 	<p>■ GR8LGP40A030 Ø 30 angular mount</p> 	<p>■ GR8LGP40A045 Ø 45 angular mount</p> 

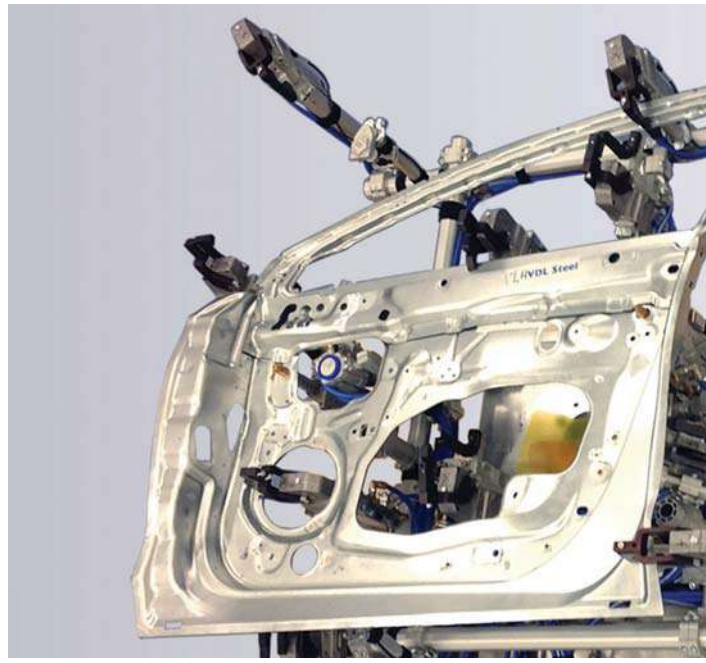
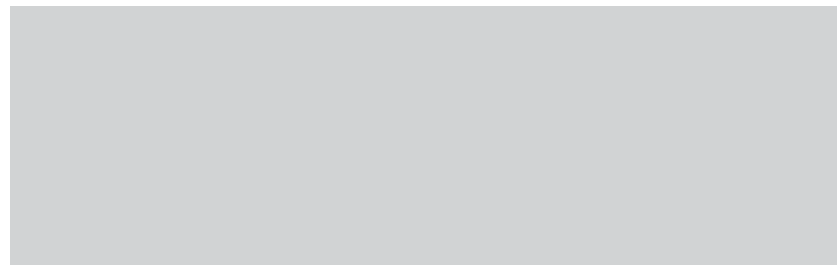
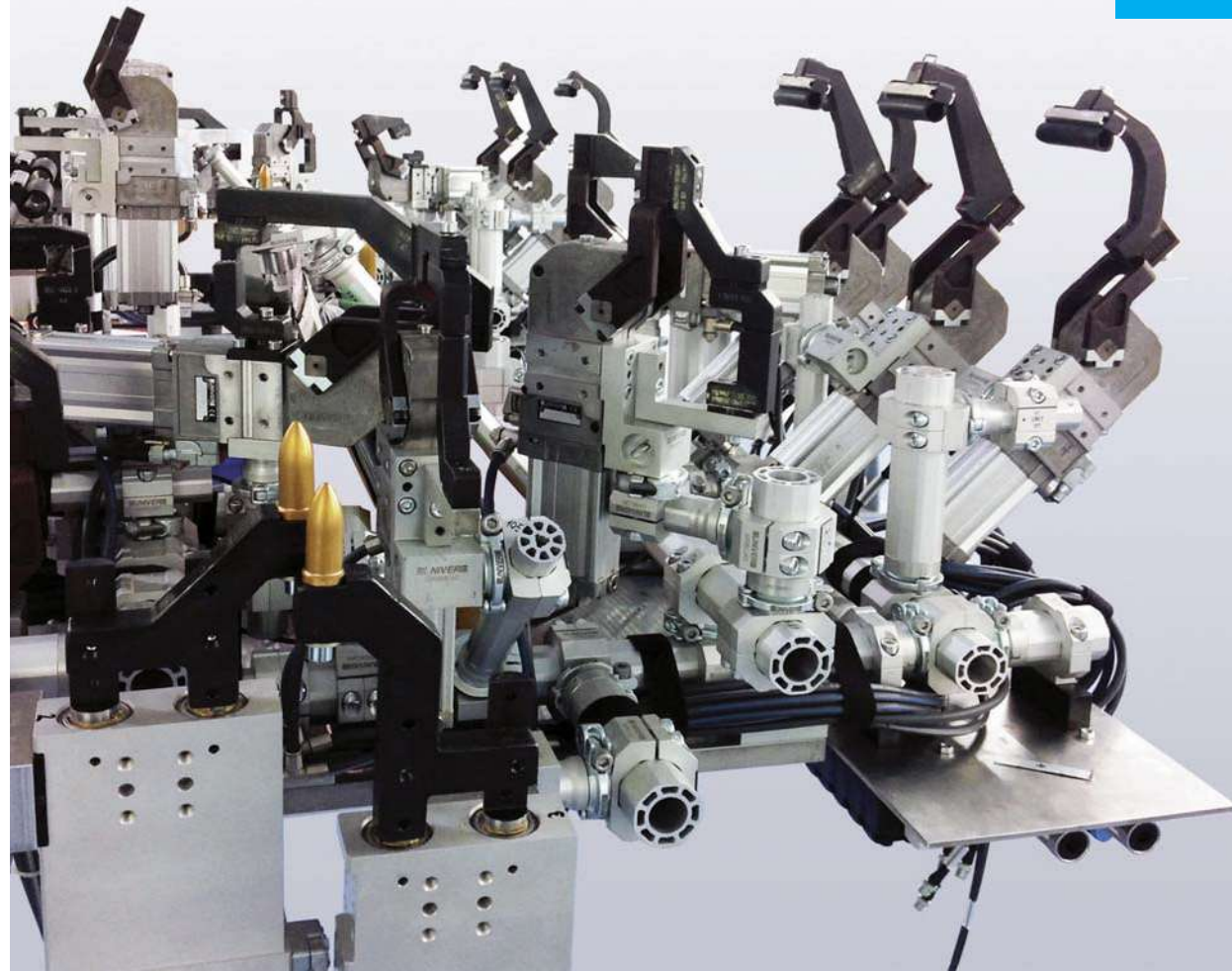
GR8

GR8 applications and details
of the components



Unlimited and complex configurations
Weight-optimized standard components and brackets
Quick installation and adjustment

COMPLETE SOLUTION
WITH **UNIVER** COMPONENTS



Compliance with
International
Standards

DIRECTIVE 94/9/CE "ATEX"	Directive that specifies the safety requirements for equipment/components for use in potentially explosive atmospheres
PRODUCT CERTIFICATION "CSA"	Product Safety certification for the North American market
DIRECTIVE 2011/65/CE "RoHS"	Directive which regulates the use and disposal of hazardous substances in electrical and electronic equipment and their waste disposal.
DIRECTIVE 2012/19/UE "WEEE"	Directive on waste electrical and electronic equipment.
DIRECTIVE "REACH"	CE 1907/2006 of the European Parliament and the Council concerning the Registration, Evaluation, Authorisation and Restriction of Chemicals.
DIRECTIVE 97/23/CE "PED"	Directive which applies to the design, manufacture and conformity assessment of pressure equipment and assemblies with a maximum allowable pressure greater than 0.5 bar.
DIRECTIVE 2006/42/CE "MACHINERY"	Directive defining essential health and safety requirements for the design, construction, installation and maintenance of machinery.
ISO 9001:2012 "QUALITY MANAGEMENT SYSTEM"	Standard specifying Quality Management System requirements.



For further information contact our Sales Office or visit our website
www.univer-group.com

PART NO.	PAGE	PART NO.	PAGE	PART NO.	PAGE	PART NO.	PAGE	PART NO.	PAGE
A-101N	3.8	AC-7013	3.48	AG-3001	3.54	AI-3511Q	3.88	AI-9030	3.57
A-102N	3.8	AC-7013P	3.48	AG-3002	3.54	AI-3512	3.88	AI-9030M	3.57
A-111N	3.8	AC-7100	3.48	AG-3009	3.54	AI-3512Q	3.88	AI-9100	3.57
A-112N	3.8	AC-7120	3.48	AG-3010	3.54	AI-3513	3.88	AI-9100M	3.57
A-121N	3.8	AC-7500	3.49	AG-3011	3.54	AI-3513Q	3.88	AI-9110	3.57
A-122N	3.8	AC-7520	3.49	AG-3012	3.54	AI-3514	3.88	AI-9110M	3.57
A-131N	3.8	AC-7900	3.49	AG-3020	3.54	AI-3514D	3.88	AI-9120	3.57
A-141N	3.8	AC-7905	3.49	AG-3021	3.54	AI-3514Q	3.88	AI-9120M	3.57
A-142N	3.8	AC-8010	3.48	AG-3040	3.54	AI-3514QD	3.88	AI-9130	3.57
A-151N	3.8	AC-8013	3.48	AG-3041	3.54	AI-3515	3.88	AI-9130M	3.57
A-161N	3.8	AC-8013P	3.48	AG-3050	3.54	AI-3515Q	3.88	AI-9200	3.57
A-162N	3.8	AC-8100	3.48	AG-3051	3.54	AI-3516	3.88	AI-9200M	3.57
A-171N	3.8	AC-8120	3.48	AG-3062	3.54	AI-3516D	3.88	AI-9210	3.57
A-299-11	3.8	AC-8500	3.49	AG-3063	3.54	AI-3516Q	3.88	AI-9210M	3.57
A-301	3.8	AC-8520	3.49	AG-3071	3.54	AI-3516QD	3.88	AI-9220	3.57
A-305	3.8	AC-8900	3.49	AG-3072	3.54	AI-3517	3.88	AI-9220M	3.57
A-326A/B/D	3.8	AC-9010	3.48	AG-3073	3.54	AI-3517Q	3.88	AI-9230	3.57
A-345	3.8	AC-9013	3.48	AG-3074	3.54	AI-3519	3.88	AI-9230M	3.57
A-350	3.8	AC-9013P	3.48	AG-3075	3.54	AI-3519Q	3.88	AI-9300	3.58
AA-0150	3.9	AC-9100	3.48	AG-3076	3.54	AI-3520	3.89	AI-9300M	3.58
AA-0157	3.9	AC-9120	3.48	AG-3081	3.55	AI-3520Q	3.89	AI-9310	3.58
AA-0170	3.9	AC-9500	3.49	AG-3082	3.55	AI-3521	3.89	AI-9310M	3.58
AA-0184	3.9	AC-9520	3.49	AG-3091	3.55	AI-3521Q	3.89	AI-9320	3.58
AA-0186	3.9	AC-N8100	3.22	AG-3092	3.55	AI-3522	3.89	AI-9320M	3.58
AA-0188	3.9	AC-N8120	3.22	AG-3100	3.55	AI-3522Q	3.89	AI-9330	3.58
AA-0211	3.9	AC-N8500	3.22	AG-3101	3.55	AI-3523	3.89	AI-9330M	3.58
AA-0213	3.9	AC-N8520	3.22	AG-3110	3.55	AI-3523Q	3.89	AI-9350	3.58
AA-0219	3.9	AE-1000	3.15	AG-3111	3.55	AI-3524	3.88	AI-9350M	3.58
AA-0231	3.9	AE-1003	3.15	AG-3210	3.55	AI-3524Q	3.88	AI-9360	3.58
AA-0233	3.9	AE-1009	3.15	AG-3211	3.55	AI-3525	3.89	AI-9360M	3.58
AA-0239	3.9	AE-1010	3.15	AG-3214	3.55	AI-3525Q	3.89	AI-9370	3.58
AA-0400	3.9	AE-1100	3.15	AG-3215	3.55	AI-3526	3.89	AI-9370M	3.58
AA-0400U	3.9	AE-1103	3.15	AG-3222	3.55	AI-3526Q	3.89	AI-9380	3.58
AA-0402	3.9	AE-1120	3.15	AG-3223	3.55	AI-3529	3.89	AI-9380M	3.58
AA-0404	3.9	AE-1121	3.15	AG-3232	3.55	AI-3550	3.89	AI-9400	3.58
AA-0450	3.9	AF-2500	3.52	AG-3233	3.55	AI-3551	3.89	AI-9400M	3.58
AB-0600	3.10	AF-2501	3.52	AG-3242	3.55	AI-3560	3.89	AI-9410	3.58
AB-0613	3.10	AF-2510	3.52	AG-3243	3.55	AI-3562	3.89	AI-9410M	3.58
AB-0640	3.10	AF-2511	3.52	AG-3256	3.55	AI-3563	3.89	AI-9420	3.58
AB-0643	3.10	AF-2517	3.52	AG-3257	3.55	AI-3570	3.89	AI-9420M	3.58
AB-0681	3.10	AF-2518	3.52	AG-3300	3.55	AI-3571	3.89	AI-9430	3.58
AB-0685	3.10	AF-2520	3.52	AG-3301	3.55	AI-3572	3.89	AI-9430M	3.58
AB-0687	3.10	AF-2521	3.52	AG-3302	3.55	AI-35B10N	3.59	AI-9500B	3.59
AB-0722	3.10	AF-2524	3.52	AG-3303	3.55	AI-35B10R	3.59	AI-9500BM	3.59
AB-0728	3.10	AF-2525	3.52	AG-3310	3.55	AI-35B10V	3.59	AI-9510B	3.59
AB-0751	3.10	AF-2530	3.52	AG-3311	3.55	AI-35B11N	3.59	AI-9510BM	3.59
AB-0755	3.10	AF-2531	3.52	AG-3312	3.55	AI-35B11R	3.59	AI-9520B	3.59
AB-0757	3.10	AF-2540	3.52	AG-3313	3.55	AI-35B11V	3.59	AI-9520BM	3.59
AB-0765	3.10	AF-2541	3.52	AG-3320	3.55	AI-35B13N	3.59	AI-9550B	3.59
AB-0771	3.10	AF-2545	3.52	AG-3321	3.55	AI-35B13R	3.59	AI-9550BM	3.59
AB-0819	3.10	AF-2546	3.52	AG-3322	3.55	AI-35B20	3.59	AI-9560B	3.59
AB-0822	3.10	AF-2550	3.53	AG-3330	3.55	AI-35B21	3.59	AI-9560BM	3.59
AB-0824	3.10	AF-2551	3.53	AG-3331	3.55	AI-35B22	3.59	AI-9570B	3.59
AB-0825	3.10	AF-2552	3.53	AG-3332	3.55	AI-35B25	3.59	AI-9570BM	3.59
AB-0826	3.10	AF-2561	3.52	AI-3500	3.56	AI-35B26	3.59	AM-5000	3.60
AB-0827	3.10	AF-2565	3.52	AI-3500Q	3.56	AI-35B27	3.59	AM-5000A	3.60
AB-0828	3.10	AF-2600	3.52	AI-3500S	3.56	AI-35B30	3.59	AM-5001	3.60
AB-0829	3.10	AF-2601	3.52	AI-3500SQ	3.56	AI-35B31	3.59	AM-5001A	3.60
AB-0830	3.10	AF-2603	3.53	AI-3501	3.56	AI-35B32	3.59	AM-5002	3.60
AB-0831	3.10	AF-2606	3.52	AI-3501Q	3.56	AI-3610	3.56	AM-5003	3.60
AB-0832	3.10	AF-2610	3.53	AI-3501S	3.56	AI-3612	3.56	AM-5003A	3.60
AB-0833	3.10	AF-2615	3.53	AI-3501SQ	3.56	AI-9000	3.57	AM-5004	3.60
AB-0885	3.10	AF-2617	3.53	AI-3502	3.56	AI-9000M	3.57	AM-5004A	3.60
AB-0886	3.10	AF-2620	3.53	AI-3502Q	3.56	AI-9010	3.57	AM-5005	3.60
AB-0888	3.10	AF-2700	3.52	AI-3503	3.56	AI-9010M	3.57	AM-5011	3.60
AB-0900	3.10	AF-2701	3.52	AI-3503Q	3.56	AI-9020	3.57	AM-5012	3.60
AC-7010	3.48	AF-2706	3.52	AI-3511	3.88	AI-9020M	3.57	AM-5015	3.60

PART NO.	PAGE	PART NO.	PAGE	PART NO.	PAGE	PART NO.	PAGE	PART NO.	PAGE
AM-5021	3.60	AM-5402	3.93	BDA-4833	3.19	BDF-4180	3.20	BE-4200	3.12
AM-5031	3.60	AM-5500	3.93	BDA-4844	3.19	BDF-4185	3.20	BE-4205	3.12
AM-5041	3.60	AM-5501	3.93	BDB-324024	3.18	BDF-4210	3.20	BE-4700	3.12
AM-5043	3.60	AM-5502	3.93	BDB-324124	3.18	BDF-4211	3.21	BE-4720	3.12
AM-5043B	3.60	AM-5503	3.93	BDB-324424	3.18	BDF-4212	3.21	BE-4730	3.12
AM-5043C	3.60	AM-5504	3.93	BDB-334424	3.18	BDF-4220	3.20	BE-4760	3.12
AM-5043D	3.60	AM-5510	3.93	BDB-344424	3.18	BDF-4221	3.21	BE-4800	3.12
AM-5050	3.60	AM-5511	3.93	BDB-354424	3.18	BDF-4222	3.21	BE-4850	3.12
AM-5051	3.60	AM-5512	3.93	BDB-364424	3.18	BDF-4230	3.20	BE-4870	3.12
AM-5052	3.60	AM-5513	3.93	BDB-374424	3.18	BDF-4231	3.21	BE-4900	3.12
AM-5060	3.92	AM-5514	3.93	BDB-384424	3.18	BDF-4232	3.21	BE-4940	3.12
AM-5061	3.92	AP-500	3.92	BDB-424024	3.18	BDF-4310	3.20	BE-5000	3.12
AM-5062	3.92	AP-520	3.92	BDB-424124	3.18	BDF-4311	3.21	BE-5020	3.12
AM-5063	3.92	AZ-0200	4.12	BDB-424424	3.18	BDF-4312	3.21	BE-5030	3.12
AM-5064	3.92	AZ4-SN003A	3.63	BDB-434424	3.18	BDF-4320	3.20	BE-5060	3.12
AM-5065	3.92	AZ4-SN004A	3.39	BDB-444424	3.18	BDF-4321	3.21	BE-5100	3.12
AM-5066	3.92	AZ4-VN0310	3.63	BDB-454424	3.18	BDF-4322	3.21	BE-5150	3.12
AM-5067	3.92	AZ4-VN0414	3.73	BDB-464424	3.18	BDF-4330	3.20	BE-5170	3.12
AM-5070	3.92	B-101N	3.7	BDB-474424	3.18	BDF-4331	3.20	BE-5200	3.12
AM-5071	3.92	B-102N	3.7	BDB-484424	3.18	BDF-4332	3.20	BE-5205	3.12
AM-5072	3.92	B10-401L24D	3.4	BDE-324024	3.18	BDF-4400	3.20	BE-5700	3.12
AM-5074	3.92	B10-403P24D	3.4	BDE-324124	3.18	BE12-3000	3.13	BE-5720	3.12
AM-5076	3.92	B10-405M24D	3.4	BDE-324424	3.18	BE12-3020	3.13	BE-5730	3.12
AM-5077	3.92	B11-401L24D	3.3	BDE-334424	3.18	BE12-3205	3.13	BE-5760	3.12
AM-5090	3.92	B11-403P24D	3.3	BDE-344424	3.18	BE12-3700	3.13	BE-5800	3.12
AM-5091	3.92	B11-405M24D	3.3	BDE-354424	3.18	BE12-3720	3.13	BE-5850	3.12
AM-5092	3.92	B11-411L24D	3.3	BDE-364424	3.18	BE12-3900	3.13	BE-5870	3.12
AM-5109	3.87	B11-413P24D	3.3	BDE-374424	3.18	BE12-3940	3.13	BE-5900	3.12
AM-5110	3.87	B11-415M24D	3.3	BDE-384424	3.18	BE12-4000	3.13	BE-5940	3.12
AM-5111	3.87	B-121N	3.7	BDE-424024	3.18	BE12-4020	3.13	BE-6000	3.12
AM-5148	3.29	B12-401L24D	3.5	BDE-424124	3.18	BE12-4205	3.13	BE-6020	3.12
AM-5151	3.29	B12-403P24D	3.5	BDE-424424	3.18	BE12-4700	3.13	BE-6030	3.12
AM-5152	3.29	B12-405M24D	3.5	BDE-434424	3.18	BE12-4720	3.13	BE-6060	3.12
AM-5160	3.92	BDA-3230	3.19	BDE-444424	3.18	BE12-4900	3.13	BE-6100	3.12
AM-5161	3.92	BDA-3231	3.19	BDE-454424	3.18	BE12-4940	3.13	BE-6150	3.12
AM-5162	3.92	BDA-3233	3.19	BDE-464424	3.18	BE12-5000	3.13	BE-6170	3.12
AM-5163	3.92	BDA-3240	3.19	BDE-474424	3.18	BE12-5020	3.13	BE-6200	3.12
AM-5164	3.92	BDA-3241	3.19	BDE-484424	3.18	BE12-5205	3.13	BE-6205	3.12
AM-5200	3.93	BDA-3244	3.19	BDF-3100	3.20	BE12-5700	3.13	BE-6700	3.12
AM-5211A	3.9	BDA-3333	3.19	BDF-3110	3.21	BE12-5720	3.13	BE-6720	3.12
AM-5211B	3.9	BDA-3344	3.19	BDF-3115	3.20	BE12-5900	3.13	BE-6730	3.12
AM-5212A	3.10	BDA-3433	3.19	BDF-3120	3.20	BE12-5940	3.13	BE-6760	3.12
AM-5212B	3.10	BDA-3444	3.19	BDF-3125	3.21	BE-3000	3.12	BE-6800	3.12
AM-5213A	3.9	BDA-3533	3.19	BDF-3140TIM	3.20	BE-3020	3.12	BE-6850	3.12
AM-5214A	3.10	BDA-3544	3.19	BDF-3180	3.20	BE-3030	3.12	BE-6870	3.12
AM-5220	3.93	BDA-3633	3.19	BDF-3185	3.20	BE-3060	3.12	BE-6900	3.12
AM-5240	3.93	BDA-3644	3.19	BDF-3190	3.20	BE-3100	3.12	BE-6940	3.12
AM-5241	3.93	BDA-3733	3.19	BDF-3191	3.21	BE-3150	3.12	BF-1060	3.13
AM-5242	3.93	BDA-3744	3.19	BDF-3210	3.20	BE-3170	3.12	BF-1061	3.13
AM-5242E	3.93	BDA-3833	3.19	BDF-3211	3.21	BE-3200	3.12	BF-1062	3.13
AM-5243	3.93	BDA-3844	3.19	BDF-3212	3.21	BE-3205	3.12	BF-1063	3.13
AM-5243E	3.93	BDA-4230	3.19	BDF-3230	3.20	BE-3700	3.12	BF-1065	3.14
AM-5254	3.93	BDA-4231	3.19	BDF-3231	3.21	BE-3720	3.12	BF-1066	3.14
AM-5255	3.93	BDA-4233	3.19	BDF-3232	3.21	BE-3730	3.12	BF-1068	3.14
AM-5256	3.93	BDA-4240	3.19	BDF-3310	3.20	BE-3760	3.12	BF-1070	3.14
AM-5259	3.93	BDA-4241	3.19	BDF-3311	3.21	BE-3800	3.12	BF-1071	3.13
AM-5260	3.93	BDA-4244	3.19	BDF-3312	3.21	BE-3850	3.12	BF-1071S	3.13
AM-5261	3.93	BDA-4333	3.19	BDF-3330	3.20	BE-3870	3.12	BF-1072	3.13
AM-5350	3.93	BDA-4344	3.19	BDF-3331	3.21	BE-3900	3.12	BF-1072S	3.13
AM-5351	3.93	BDA-4433	3.19	BDF-3332	3.21	BE-3940	3.12	BF-1085	3.14
AM-5352	3.93	BDA-4444	3.19	BDF-3400	3.20	BE-4000	3.12	BF-1150	3.13
AM-5353	3.93	BDA-4533	3.19	BDF-4100	3.20	BE-4020	3.12	BF-1151	3.13
AM-5354	3.93	BDA-4544	3.19	BDF-4110	3.21	BE-4030	3.12	BF-1152	3.13
AM-5355	3.93	BDA-4633	3.19	BDF-4115	3.20	BE-4060	3.12	BF-1153	3.13
AM-5356	3.93	BDA-4644	3.19	BDF-4120	3.20	BE-4100	3.12	BF-1154	3.14
AM-5400	3.93	BDA-4733	3.19	BDF-4125	3.21	BE-4150	3.12	BF-1155	3.14
AM-5401	3.93	BDA-4744	3.19	BDF-4140 TIM	3.20	BE-4170	3.12	BF-1160	3.13

PART NO.	PAGE	PART NO.	PAGE	PART NO.	PAGE	PART NO.	PAGE	PART NO.	PAGE
BF-1161	3.13	CL-130	3.26	CM-413P	3.25	CM-9500A	3.28	DC-0309	3.87
BF-1162	3.14	CL-200	3.28	CM-418R	3.26	CM-9520	3.28	DC-0310	3.87
BF-1175	3.14	CL-200A	3.28	CM-419R	3.26	CM-9521	3.28	DD-011	3.87
BF-1190	3.14	CL-203	3.28	CM-420	3.26	CM-9524	3.28	DD-013	3.87
BF-3060	3.13	CL-220	3.28	CM-420A	3.26	CM-9580	3.28	DD-040	3.87
BF-3061	3.13	CL-221	3.28	CM-420P	3.26	CM-9585	3.28	DD-040-2C	3.36
BF-3063	3.13	CL-224	3.28	CM-421R	3.26	CM-9590	3.28	DD-041	3.87
BF-3064	3.14	CL-300	3.28	CM-422R	3.26	CM-9600	3.28	DD-042	3.87
BF-3071	3.13	CL-301	3.28	CM-423	3.26	CM-9602A	3.28	DD-050	3.87
BF-3072	3.13	CL-302A	3.28	CM-423A	3.26	CM-9620	3.28	DD-051	3.87
BF-3082	3.14	CL-303A	3.28	CM-423D	3.26	CM-9621	3.28	DD-051-2C	3.36
BF-3175	3.14	CL-320	3.28	CM-423E	3.26	CM-9622	3.28	DD-051L030	3.87
BF-3190	3.14	CL-321	3.28	CM-423F	3.26	CM-9680	3.28	DD-052	3.87
BF-3191	3.14	CL-322	3.28	CM-424E	3.26	CM-9685	3.28	DD-052L030	3.87
BF-4060	3.13	CL-9102A	3.24	CM-424F	3.26	CM-9690	3.28	DD-060	3.87
BF-4061	3.13	CL-9102P	3.24	CM-425E	3.26	CP-100	3.29	DD-070	3.87
BF-4062	3.13	CL-9103A	3.24	CM-425F	3.26	CP-101	3.29	DD-151	3.87
BF-4063	3.13	CL-9103P	3.24	CM-426A	3.26	CP-105	3.29	DD-351	3.87
CH-250	3.50	CL-9110A	3.25	CM-430	3.26	CP-106	3.29	DD-551	3.87
CH-252	3.50	CL-9110P	3.25	CM-430E	3.26	CP-110	3.29	DE-052L030	3.86
CH-254	3.50	CL-9111A	3.25	CM-435E	3.26	CP-111	3.29	DE-352	3.86
CH-256	3.50	CL-9111P	3.25	CM-440E	3.26	CP-112	3.29	DE-355	3.86
CH-260	3.50	CL-9113A	3.25	CM-500	3.28	CP-113	3.29	DE-452	3.86
CH-262	3.50	CL-9113P	3.25	CM-500A	3.28	CP-9100	3.29	DE-552	3.86
CH-264	3.50	CL-9118R	3.27	CM-520	3.28	CP-9101	3.29	DE-555	3.86
CH-266	3.50	CL-9120	3.27	CM-521	3.28	CP-9105	3.29	DE-642I	3.86
CH-270	3.50	CL-9120A	3.27	CM-524	3.28	CP-9110	3.29	DE-652	3.86
CH-272	3.50	CL-9120P	3.27	CM-580	3.28	CP-9111	3.29	DE-652I	3.86
CH-274	3.50	CL-9121R	3.27	CM-585	3.28	CP-9112	3.29	DE-655I	3.86
CH-276	3.50	CL-9123	3.27	CM-590	3.28	CP-9113	3.29	DF-001	5.21
CH-280	3.50	CL-9123A	3.27	CM-600	3.28	CP-911G	3.26	DF-003	1.23
CH-282	3.50	CL-9123D	3.27	CM-602A	3.28	CP-911N	3.26	DF-004	1.23
CH-284	3.50	CL-9130	3.27	CM-620	3.28	CP-911R	3.26	DF-220	5.21
CH-286	3.50	CL-9200	3.28	CM-621	3.28	CP-911V	3.26	DF-220M08	5.21
CL-100A	3.24	CL-9200A	3.28	CM-622	3.28	CP-912G	3.26	DF-220M12	5.21
CL-100P	3.24	CL-9203	3.28	CM-680	3.28	CP-912N	3.26	DF-330	5.21
CL-101A	3.24	CL-9220	3.28	CM-685	3.28	CP-912R	3.26	DF-330M08	5.21
CL-101P	3.24	CL-9221	3.28	CM-690	3.28	CP-913R	3.26	DF-330M12	5.21
CL-102A	3.24	CL-9224	3.28	CM-9402A	3.24	CP-915R	3.26	DF-440	5.21
CL-102P	3.24	CL-9300	3.28	CM-9402P	3.24	CP-916R	3.26	DF-440M08	5.21
CL-103A	3.24	CL-9301	3.28	CM-9403A	3.24	D-500	3.87	DF-440M12	5.21
CL-103P	3.24	CL-9302A	3.28	CM-9403P	3.24	D-530-200	3.87	DF-770	5.21
CL-104A	3.24	CL-9303A	3.28	CM-9410A	3.25	D-530-30	3.87	DF-770M08	5.21
CL-104P	3.24	CL-9320	3.28	CM-9410P	3.25	D-530-50	3.87	DF-770M12	5.22
CL-105A	3.24	CL-9321	3.28	CM-9411A	3.25	D-530C-100	3.46	DF-R200L02	5.22
CL-105P	3.24	CL-9322	3.28	CM-9411P	3.25	D-530C-200	3.46	DF-R200M08	5.22
CL-106A	3.24	CM-400A	3.24	CM-9413A	3.25	D-535-200	3.87	DF-T200L03	5.22
CL-106AL	3.24	CM-400P	3.24	CM-9413P	3.25	D-535-30	3.87	DF-T200M08	5.22
CL-110A	3.25	CM-401A	3.24	CM-9418R	3.27	D-535-50	3.87	DH-200	5.22
CL-110P	3.25	CM-401P	3.24	CM-9420	3.27	D-535U40300	3.3	DH-200M08	5.22
CL-111A	3.25	CM-402A	3.24	CM-9420A	3.27	D-535U40500	3.3	DH-200M12	5.22
CL-111P	3.25	CM-402P	3.24	CM-9420P	3.27	DA-0050	3.87	DH-500	5.22
CL-112A	3.25	CM-403A	3.24	CM-9421R	3.27	DA-0051	3.87	DH-500M08	5.22
CL-112P	3.25	CM-403P	3.24	CM-9423	3.27	DA-0106	3.87	DH-500M12	5.22
CL-113A	3.25	CM-404A	3.24	CM-9423A	3.27	DA-0108	3.87	DH-700	5.22
CL-113P	3.25	CM-404P	3.24	CM-9423D	3.27	DA-0124	3.87	DH-700M08	5.22
CL-118R	3.26	CM-405A	3.24	CM-9423E	3.27	DB-0501	3.87	DH-700M12	5.22
CL-119R	3.26	CM-405P	3.24	CM-9423F	3.27	DB-0502	3.87	DHF-0020100	5.21
CL-120	3.26	CM-406A	3.24	CM-9424E	3.27	DB-0507	3.87	DHF-033M08	5.22
CL-120A	3.26	CM-406AL	3.24	CM-9424F	3.27	DB-0509	3.87	DHF-033M12	5.22
CL-120P	3.26	CM-410A	3.25	CM-9425E	3.27	DB-0510	3.87	DHF-053M08	5.22
CL-121R	3.26	CM-410P	3.25	CM-9425F	3.27	DB-0607	3.55	DHF-053M12	5.22
CL-122R	3.26	CM-411A	3.25	CM-9430	3.27	DB-0608	3.55	DH-K032050	5.22
CL-123	3.26	CM-411P	3.25	CM-9430E	3.27	DB-0610	3.55	DH-K063125	5.22
CL-123A	3.26	CM-412A	3.25	CM-9435E	3.27	DC-0301	3.87	DH-K160200	5.22
CL-123D	3.26	CM-412P	3.25	CM-9440E	3.27	DC-0302	3.87	DH-M10	5.22
CL-126A	3.26	CM-413A	3.25	CM-9500	3.28	DC-0307	3.87	DH-M10DF	5.21

PART NO.	PAGE	PART NO.	PAGE	PART NO.	PAGE	PART NO.	PAGE	PART NO.	PAGE
DH-M12	5.22	G-6255	3.35	GL-6366	3.38	GR8B30S6000	7.4	HZ9N12110060	3.94
DH-M12DF	5.21	G-6260	3.35	GL-6433	3.37	GR8B456000	7.4	HZ9N12110080	3.94
DH-M16	5.22	G-6261	3.35	GL-6444	3.38	GR8B706000	7.4	HZ9N12150060	3.94
DH-M16DF	5.21	G-6266	3.35	GL-6455	3.38	GR8BB30	7.5	HZ9N12150080	3.94
DH-M20	5.22	G-6333	3.34	GL-6466	3.38	GR8BB45	7.5	HZ9N12A	3.94
DH-M20DF	5.21	G-6344	3.35	GL-6533	3.37	GR8BB70	7.5	HZ9N12B	3.94
DH-M25	5.22	G-6355	3.35	GL-6544	3.38	GR8BC30	7.5	HZ9N12C	3.94
DH-M25DF	5.21	G-6366	3.35	GL-6555	3.38	GR8BC45	7.5	HZ9N1F	3.94
DH-S025	5.22	G-6433	3.34	GL-6566	3.38	GR8CJ30	7.4	HZ9N2F	3.94
DH-S032	5.22	G-6444	3.35	GL-6633	3.37	GR8CJ45	7.4	HZ9NC02	3.94
DH-S040	5.22	G-6455	3.35	GL-6644	3.38	GR8CJ70	7.4	HZ9NC04	3.94
DH-S050	3.22	G-6466	3.35	GL-6655	3.38	GR8CJD30	7.4	HZ9NM08-0200	3.94
DMA	6.7	G-6533	3.34	GL-6666	3.38	GR8CJD45	7.4	HZ9NP02	3.94
DMS	6.5	G-6544	3.35	GL-6733	3.37	GR8CM4545	7.4	HZ9NP04	3.94
E-0220	3.30	G-6555	3.35	GL-6744	3.38	GR8CM7045	7.4	HZ9P400318	4.10
E-0222	3.30	G-6566	3.35	GL-6755	3.38	GR8ECI45	7.4	HZ9P400618	4.10
E-0240	3.30	G-6633	3.34	GL-6766	3.38	GR8EOA	7.4	HZ9P401018	4.10
E-0244	3.30	G-6644	3.35	GL-6833	3.37	GR8HD4545	7.4	HZ9P500314	4.10
E-0270	3.30	G-6655	3.35	GL-6844	3.38	GR8HD7070	7.4	HZ9P500614	4.10
E-0277	3.30	G-6666	3.35	GL-6855	3.38	GR8IK	7.4	HZ9P501014	4.10
E-0420	3.31	G-6733	3.34	GL-6866	3.38	GR8LH	7.4	HZ9P630314	4.10
E-0422	3.31	G-6744	3.35	GP-6100	3.36	GR8MF40	7.5	HZ9P630614	4.10
E-0440	3.31	G-6755	3.35	GP-6110	3.36	GR8MF50	7.5	HZ9P631014	4.10
E-0444	3.31	G-6766	3.35	GP-611212	3.36	GR8MFGL	7.5	HZ9PB400318	4.10
E-0470	3.31	G-6833	3.34	GP-611806	3.36	GR8MP12	7.5	HZ9PB400618	4.10
E-0477	3.31	G-6844	3.35	GP-6210	3.39	GR8MP18	7.5	HZ9PB401018	4.10
E-0522	3.30	G-6855	3.35	GP-6211	3.39	GR8MP19	7.5	HZ9PB500314	4.10
E-0622	3.30	G-6866	3.35	GP-6212	3.39	GR8MP30	7.5	HZ9PB500614	4.10
E-0722	3.30	G-7230	3.41	GP-6220	3.39	GR8RJ30	7.4	HZ9PB501014	4.10
E-0822	3.31	G-7231	3.41	GP-6221	3.39	GR8RJ45	7.4	HZ9PB630314	4.10
E-0922	3.31	G-7233	3.41	GP-6222	3.39	GR8SCB30	7.4	HZ9PB630614	4.10
E-1022	3.31	G-7290	3.41	GP-6230	3.39	GR8SCI30	7.4	HZ9PB631014	4.10
E-15402A	3.32	G-7291	3.41	GP-6231	3.39	GR8SM3030	7.4	HZ9PBS400318	4.10
E-15403A	3.32	G-7299	3.41	GP-6232	3.39	GR8SR40	7.5	HZ9PBS400618	4.10
E-15412A	3.32	G-7333	3.41	GP-6240	3.39	GR8RS50	7.5	HZ9PBS401018	4.10
E-15420	3.32	G-7399	3.41	GP-6241	3.39	GR8RS50M8	7.5	HZ9PBS500314	4.10
E-15420A	3.32	G-7433	3.41	GP-6242	3.39	GR8SS50	7.5	HZ9PBS500614	4.10
E-15422G	3.32	G-7499	3.41	GP-6285	3.39	GR8SV	7.5	HZ9PBS501014	4.10
E-15422N	3.32	G-7533	3.41	GP-6310	3.36	GZR-100	3.46	HZ9PBS630314	4.10
E-15422R	3.32	G-7599	3.41	GP-6311	3.36	GZR-101	3.46	HZ9PBS630614	4.10
E-4500	3.30	G-7885	3.41	GP-6312	3.36	GZR-102	3.46	HZ9PBS631014	4.10
E-4505	3.30	G-7900-02	3.41	GP-6320	3.36	GZR-V10004	3.39	HZE0B08GM	4.5
F-0220	3.33	G-7900-03	3.41	GP-6321	3.36	GZR-V10006	3.39	HZE0B08GMV	4.5
F-0222	3.33	G-7900-04	3.41	GP-6322	3.36	GZR-V10008	3.39	HZE0C08GM	4.6
F-0240	3.33	G-7900-05	3.41	GP-6330	3.36	GZR-V20004	3.39	HZE0D08GM	4.6
F-0244	3.33	G-7900-06	3.41	GP-6331	3.36	GZR-V20006	3.39	HZE0F08G	4.3
F-0270	3.33	G-7900-07	3.41	GP-6332	3.36	GZR-V20008	3.39	HZE0L08G	4.4
F-0277	3.33	G-7900-08	3.41	GP-6340	3.36	GZR-V20L004	3.39	HZE0N08G	4.7
F-0522	3.33	G-7900-09	3.41	GP-6341	3.36	GZR-V20L006	3.39	HZE0P08G	4.7
F-0544	3.33	G-7900-10	3.41	GP-6342	3.36	GZR-V20L008	3.39	HZE0R08G	4.4
F-0577	3.33	G-7900-11	3.41	GP-6380	3.36	GZR-VV1006	3.20	HZE0R08GM	4.4
F-0622	3.33	G-7900-12	3.41	GP-6385	3.36	GZR-VV1008	3.20	HZE0R08GMV	4.4
F-0644	3.33	GL-6230	3.37	GP-6400-1	3.36	GZR-VV1010	3.20	HZE0S08G	4.8
F-0677	3.33	GL-6231	3.37	GP-6400-2	3.36	HA ...	5.2	HZE0Y08G	4.7
F-0722	3.33	GL-6233	3.37	GP-6400-5	3.36	HAR ...	5.5	HZE0Z200	4.9
F-0744	3.33	GL-6240	3.38	GP-6411	3.39	HB ...	5.6	HZE0Z210	4.9
F-0777	3.33	GL-6241	3.38	GP-6512-01MF	3.36	HC ...	5.9	HZE0Z300	4.9
F-4500	3.33	GL-6244	3.38	GP-6512-02MF	3.36	HD ...	5.13	HZE0Z310	4.9
F-4505	3.33	GL-6250	3.38	GP-6512-03MF	3.36	HEA ...	5.20	HZE0Z401	4.9
G-6230	3.34	GL-6251	3.38	GP-6512-05MF	3.36	HEC ...	5.20	HZE0Z402	4.9
G-6231	3.34	GL-6255	3.38	GP-6512-06MF	3.36	HED ...	5.20	HZE0Z600	4.9
G-6233	3.34	GL-6260	3.38	GP-6514-01MF	3.36	HFA ...	5.20	HZE0Z600SS	4.9
G-6240	3.35	GL-6261	3.38	GP-6514-02MF	3.36	HFC ...	5.20	HZE0Z601	4.9
G-6241	3.35	GL-6266	3.38	GP-6514-03MF	3.36	HGC ...	5.16	HZE0Z602	4.9
G-6244	3.35	GL-6333	3.37	GP-6514-05MF	3.36	HGO ...	5.18	HZE0Z603	4.9
G-6250	3.35	GL-6344	3.38	GP-6514-06MF	3.36	HGU ...	5.19	HZE0Z610	4.9
G-6251	3.35	GL-6355	3.38	GP-651418	3.36	HZ9464G	4.10	HZE0Z611	4.9

PART NO.	PAGE	PART NO.	PAGE	PART NO.	PAGE	PART NO.	PAGE	PART NO.	PAGE
HZE0Z660	4.9	HZE2Z654	4.9	KF-10160AS	1.8	KF-15050	1.4	KLF-14125	1.4
HZE1B10GM	4.5	HZE2Z658	4.9	KF-10200A	1.8	KF-15080	1.4	KM-032000	5.22
HZE1B10GMV	4.5	HZE2Z660	4.9	KF-10200AS	1.8	KF-15125	1.4	KM-032050-1	5.22
HZE1B15GM	4.5	HZE2Z670	4.9	KF-10250AC	1.9	KF-15160	1.8	KM-063100-1	5.22
HZE1B15GMV	4.5	HZE7Z400	4.9	KF-10320AC	1.9	KF-15250	1.9	KM-125000-1	5.22
HZE1C10GM	4.6	HZE7Z470	4.9	KF-11032	1.4	KF-15320	1.9	L1-N...	2.3
HZE1C15GM	4.6	HZE7Z480	4.9	KF-11032S	1.4	KF-17032	1.4	L6...	2.4
HZE1D10GM	4.6	HZE7Z490	4.9	KF-11040	1.4	KF-17040	1.4	LAE	6.8
HZE1D15GM	4.6	HZRE10	4.11	KF-11040S	1.4	KF-17050	1.4	LAGE	6.8
HZE1F10G	4.3	HZRE20	4.11	KF-11050	1.4	KF-17080	1.4	LAGP	6.7
HZE1F15G	4.3	HZRM08G	4.12	KF-11050S	1.4	KF-17125	1.4	LCA	6.5
HZE1L10G	4.4	HZRM310	4.12	KF-11063	1.4	KF-17160	1.8	LCE	6.8
HZE1L15G	4.4	HZRM310A	4.12	KF-11063S	1.4	KF-17250	1.9	LCG	6.5
HZE1N10G	4.7	HZRM603	4.12	KF-11080	1.4	KF-17320	1.9	LCJ	6.5
HZE1N15G	4.7	HZRM603A	4.12	KF-11080S	1.4	KF-19032	1.4	LCL	6.6
HZE1P10G	4.7	HZRM610	4.12	KF-11100	1.4	KF-19032CN	1.4	LCM	6.6
HZE1P15G	4.7	HZRM611	4.12	KF-11100S	1.4	KF-19032CTA	1.4	LCO	6.6
HZE1R10GM	4.4	HZRM652	4.12	KF-11125	1.4	KF-19032SC	1.4	LCP	6.5
HZE1R10GMV	4.4	HZRM654	4.12	KF-11125S	1.4	KF-19040	1.4	LCT	6.5
HZE1R15GM	4.4	HZRM658	4.12	KF-11160	1.8	KF-19040050CN	1.4	LCX	6.6
HZE1R15GMV	4.4	HZRP1008GA	4.11	KF-11160S	1.8	KF-19040CTA	1.4	LCY	6.6
HZE1RL10GM	4.4	HZRP1008GB	4.11	KF-11200	1.8	KF-19040SC	1.4	LCZ	6.5
HZE1RL15GM	4.4	HZRP1008GC	4.11	KF-11200S	1.8	KF-19050	1.4	LGE	6.8
HZE1S10G	4.8	HZRP12	4.11	KF-11250C	1.9	KF-19050CTA	1.4	LGP	6.7
HZE1S15G	4.8	HZRP1310	4.11	KF-11320C	1.9	KF-19050SC	1.4	LNE	6.8
HZE1Y10G	4.7	HZRP2008GA	4.11	KF-12032	1.4	KF-19063	1.4	LSL	6.6
HZE1Y15G	4.7	HZRP2008GB	4.11	KF-12040	1.4	KF-19063080CN	1.4	LSP	6.6
HZE1Z200	4.9	HZRP2008GC	4.11	KF-12050	1.4	KF-19063CTA	1.4	LSP50U	6.6
HZE1Z210	4.9	HZRP2008GD	4.11	KF-12063	1.4	KF-19063SC	1.4	LTP	6.6
HZE1Z300	4.9	HZRP2008GE	4.11	KF-12080	1.4	KF-19080	1.4	LUP	6.6
HZE1Z310	4.9	HZRP2310	4.11	KF-12100	1.4	KF-19080CTA	1.4	M...	1.2
HZE1Z401	4.9	IBM	6.4	KF-12125	1.4	KF-19080SC	1.4	MF-12008	1.2
HZE1Z402	4.9	IBP	6.4	KF-12160	1.8	KF-19100	1.4	MF-12012	1.2
HZE1Z600	4.9	J1...	1.29	KF-12200	1.8	KF-19100125CN	1.4	MF-12020	1.2
HZE1Z600SS	4.9	J3...	1.30	KF-12250	1.9	KF-19100CTA	1.4	MF-13008	1.2
HZE1Z601	4.9	J64RS...	1.30	KF-12320	1.9	KF-19100SC	1.4	MF-13012	1.2
HZE1Z602	4.9	J64RT2...	1.31	KF-13032	1.4	KF-19125CTA	1.4	MF-13020	1.2
HZE1Z603	4.9	J65...	1.31	KF-13040	1.4	KF-19125SC	1.4	MF-15008	1.2
HZE1Z610	4.9	JL...	1.32	KF-13050	1.4	KF-19160200CN	1.8	MF-15012	1.2
HZE1Z611	4.9	JT...	1.33	KF-13063	1.4	KF-19160CTA	1.8	MF-15020	1.2
HZE1Z652	4.9	JX1...	1.33	KF-13080	1.4	KF-19200CTA	1.8	MF-15032	1.2
HZE1Z654	4.9	JX2...	1.33	KF-13100	1.4	KF-22025	1.2	MF-17008	1.2
HZE1Z658	4.9	K...	1.8-1.9	KF-13125	1.4	KF-22040	1.4	MF-17012	1.2
HZE1Z660	4.9	KD...	1.7	KF-13160	1.8	KF-22050	1.4	MF-17020	1.2
HZE1Z670	4.9	KDF-14032	1.7	KF-13200	1.8	KF-22080	1.4	MF-17032	1.2
HZE2B15GM	4.5	KDF-14040	1.7	KF-13250	1.9	KF-23025	1.2	MF-20008	1.2
HZE2B15GMV	4.5	KDF-14050	1.7	KF-14032	1.6	KF-23040	1.4	MF-20012	1.2
HZE2C15GM	4.6	KDF-14063	1.7	KF-14032AP	1.6	KF-23050	1.4	MF-20020	1.2
HZE2D15GM	4.6	KDF-14080	1.7	KF-14040	1.6	KF-23080	1.4	MF-21008	1.2
HZE2F15G	4.3	KDF-14100	1.7	KF-14040AP	1.6	KF-24020	1.19	MF-21012	1.2
HZE2L15G	4.4	KDF-14125	1.7	KF-14050	1.6	KF-24032	1.4	MF-21016	1.2
HZE2R15GM	4.4	KE...	1.6	KF-14050AP	1.6	KF-24040	1.4	MF-21020	1.2
HZE2R15GMV	4.4	KF-10032A	1.4	KF-14063	1.6	KF-24050	1.4	MF-22016	1.2
HZE2RL15GM	4.4	KF-10032AS	1.4	KF-14063AP	1.6	KF-24080	1.4	MF-22020	1.2
HZE2Z210	4.9	KF-10040A	1.4	KF-14080	1.6	KF-41032	1.11	MF-22025	1.2
HZE2Z300	4.9	KF-10040AS	1.4	KF-14080AP	1.6	KF-41040050	1.4	MF-23012	1.2
HZE2Z310	4.9	KF-10050A	1.4	KF-14100	1.6	KF-41063080	1.4	MF-23020	1.2
HZE2Z500	4.9	KF-10050AS	1.4	KF-14100AP	1.6	KF-41100125	1.4	MF-24012	1.2
HZE2Z501	4.9	KF-10063A	1.4	KF-14125	1.6	KF-41160200	1.8	MF-24020	1.2
HZE2Z600	4.9	KF-10063AS	1.4	KF-14125AP	1.6	KF-41250	1.9	NFZ...	2.9
HZE2Z600SS	4.9	KF-10080A	1.4	KF-14160	1.8	KL...	1.4	NQZ...	2.8
HZE2Z601	4.9	KF-10080AS	1.4	KF-14160AP	1.8	KLF-14032	1.4	NTZ...	2.8
HZE2Z602	4.9	KF-10100A	1.4	KF-14200	1.8	KLF-14040	1.4	OV...	1.19
HZE2Z603	4.9	KF-10100AS	1.4	KF-14200AP	1.8	KLF-14050	1.4	OVF-11018	1.19
HZE2Z610	4.9	KF-10125A	1.4	KF-14250	1.9	KLF-14063	1.4	OVF-11025	1.19
HZE2Z611	4.9	KF-10125AS	1.4	KF-15032	1.4	KLF-14080	1.4	OVF-11032	1.19
HZE2Z652	4.9	KF-10160A	1.8	KF-15040	1.4	KLF-14100	1.4	OVF-11040	1.19

PART NO.	PAGE	PART NO.	PAGE	PART NO.	PAGE	PART NO.	PAGE	PART NO.	PAGE
OVF-11050	1.19	P10F24424	3.63	P10SF505	3.63	P15D26124	3.72	P15F733	3.71
OVF-11063	1.19	P10F26024	3.63	P10SF515	3.64	P15D26624	3.72	P15F74424	3.72
OVF-11080	1.19	P10F26124	3.63	P10SF550	3.63	P15D34424	3.72	P15F76624	3.72
OVF-12018	1.19	P10F26624	3.63	P10SF560	3.63	P15D36624	3.72	P15F78824	3.76
OVF-12025	1.19	P10F28024	3.67	P10SF570	3.63	P15D44424	3.72	P15F79924	3.76
OVF-12032	1.19	P10F28124	3.67	P10SS1204M	3.63-3.66	P15D46624	3.72	P15F833	3.71
OVF-12040	1.19	P10F28824	3.67	P10SS1206M	3.63-3.66	P15D54424	3.72	P15F84424	3.72
OVF-12050	1.19	P10F29024	3.67	P10SS1208M	3.63-3.66	P15D56624	3.72	P15F86624	3.72
OVF-12063	1.19	P10F29124	3.67	P10SS1210M	3.63-3.66	P15D64424	3.72	P15F88824	3.76
OVF-12080	1.19	P10F29924	3.67	P10SS1212M	3.63-3.66	P15D66624	3.72	P15F89924	3.76
OVF-13018	1.19	P10F333	3.62	P10SS1404M	3.63-3.66	P15D74424	3.72	P15SB100	3.75
OVF-13025	1.19	P10F34424	3.63	P10SS1406M	3.63-3.66	P15D76624	3.72	P15SB110	3.75
OVF-13032	1.19	P10F36624	3.63	P10SS1408M	3.63-3.66	P15D84424	3.72	P15SB200	3.75
OVF-13040	1.19	P10F38824	3.67	P10SS1410M	3.63-3.66	P15D86624	3.72	P15SB210	3.75
OVF-13050	1.19	P10F39924	3.67	P10SS1412M	3.63-3.66	P15EB250...	3.82	P15SB300	3.75
OVF-13063	1.19	P10F433	3.62	P10STR01	3.63	P15EB251...	3.82	P15SB310	3.75
OVF-13080	1.19	P10F44424	3.63	P10STR02	3.63	P15EB255...	3.82	P15SB400	3.75
P10B230	3.64	P10F46624	3.63	P10STR05	3.63	P15EB355...	3.82	P15SB410	3.75
P10B231	3.64	P10F48824	3.67	P15B230	3.74	P15EB455...	3.82	P15SB500	3.75
P10B233	3.64	P10F49924	3.67	P15B231	3.74	P15EB555...	3.82	P15SB502	3.78
P10B24024	3.65	P10F533	3.62	P15B233	3.74	P15EB655...	3.82	P15SB505	3.75
P10B24124	3.65	P10F54424	3.63	P15B24024	3.74	P15EB755...	3.82	P15SB550	3.75
P10B24424	3.65	P10F56624	3.63	P15B24124	3.74	P15EB855...	3.82	P15SB560	3.75
P10B26024	3.65	P10F58824	3.67	P15B24424	3.74	P15EF250...	3.80	P15SB570	3.75
P10B26124	3.65	P10F59924	3.67	P15B26024	3.74	P15EF251...	3.80	P15SF100	3.73
P10B26624	3.65	P10F633	3.62	P15B26124	3.74	P15EF255...	3.80	P15SF110	3.73
P10B28024	3.68	P10F64424	3.63	P15B26624	3.74	P15EF355...	3.80	P15SF200	3.73
P10B28124	3.68	P10F66624	3.63	P15B28024	3.77	P15EF455...	3.80	P15SF210	3.73
P10B28824	3.68	P10F68824	3.67	P15B28124	3.77	P15EF555...	3.80	P15SF300	3.73
P10B29024	3.68	P10F69924	3.67	P15B28824	3.77	P15EF655...	3.80	P15SF310	3.73
P10B29124	3.68	P10F733	3.62	P15B29024	3.77	P15EF755...	3.80	P15SF400	3.73
P10B29924	3.68	P10F74424	3.63	P15B29124	3.77	P15EF855...	3.80	P15SF410	3.73
P10B333	3.64	P10F76624	3.63	P15B29924	3.77	P15F230	3.71	P15SF499-02	3.81
P10B34424	3.65	P10F78824	3.67	P15B333	3.74	P15F231	3.71	P15SF499-03	3.81
P10B36624	3.65	P10F79924	3.67	P15B34424	3.74	P15F233	3.71	P15SF499-04	3.81
P10B38824	3.68	P10F833	3.62	P15B36624	3.74	P15F24024	3.72	P15SF499-05	3.81
P10B39924	3.68	P10F84424	3.63	P15B38824	3.77	P15F24124	3.72	P15SF499-06	3.81
P10B433	3.64	P10F86624	3.63	P15B39924	3.77	P15F24424	3.72	P15SF499-07	3.81
P10B44424	3.65	P10F88824	3.67	P15B433	3.74	P15F26024	3.72	P15SF499-08	3.81
P10B46624	3.65	P10F89924	3.67	P15B44424	3.74	P15F26124	3.72	P15SF499-09	3.81
P10B48824	3.68	P10SB100	3.65	P15B46624	3.74	P15F26624	3.72	P15SF499-10	3.81
P10B49924	3.68	P10SB107	3.65	P15B48824	3.77	P15F28024	3.76	P15SF500	3.73
P10B533	3.64	P10SB110	3.65	P15B49924	3.77	P15F28124	3.76	P15SF505	3.73
P10B54424	3.65	P10SB117	3.65	P15B533	3.74	P15F28824	3.76	P15SF515	3.73
P10B56624	3.65	P10SB200	3.65	P15B54424	3.74	P15F29024	3.76	P15SF550	3.73
P10B58824	3.68	P10SB207	3.65	P15B56624	3.74	P15F29124	3.76	P15SF560	3.73
P10B59924	3.68	P10SB210	3.65	P15B58824	3.77	P15F29924	3.76	P15SF570	3.73
P10B633	3.64	P10SB217	3.65	P15B59924	3.77	P15F333	3.71	P15SS1204M	3.73
P10B64424	3.65	P10SB304	3.65	P15B633	3.74	P15F34424	3.72	P15SS1204MFP	3.73
P10B66624	3.65	P10SB314	3.65	P15B64424	3.74	P15F36624	3.72	P15SS1204MP	3.73
P10B68824	3.68	P10SB404	3.65	P15B66624	3.74	P15F38824	3.76	P15SS1206M	3.73
P10B69924	3.68	P10SB414	3.65	P15B68824	3.77	P15F39924	3.76	P15SS1208M	3.73
P10B733	3.64	P10SB500	3.65	P15B69924	3.77	P15F433	3.71	P15SS1208MF	3.73
P10B74424	3.65	P10SB502	3.69	P15B733	3.74	P15F44424	3.72	P15SS1404M	3.73
P10B76624	3.65	P10SB505	3.65	P15B74424	3.74	P15F46624	3.72	P15SS1404MFP	3.73
P10B78824	3.68	P10SB550	3.65	P15B76624	3.74	P15F48824	3.76	P15SS1404MP	3.73
P10B79924	3.68	P10SB560	3.65	P15B78824	3.77	P15F49924	3.76	P15SS1406M	3.73
P10B833	3.64	P10SB570	3.65	P15B79924	3.77	P15F533	3.71	P15SS1408M	3.73
P10B84424	3.65	P10SF100	3.63	P15B833	3.74	P15F54424	3.72	P15SS1408MF	3.73
P10B86624	3.65	P10SF110	3.63	P15B84424	3.74	P15F56624	3.72	P15STR01	3.73
P10B88824	3.68	P10SF200	3.63	P15B86624	3.74	P15F58824	3.76	P15STR02	3.73
P10B89924	3.68	P10SF210	3.63	P15B88824	3.77	P15F59924	3.76	P15STR05	3.73
P10F230	3.62	P10SF300	3.64	P15B89924	3.77	P15F633	3.71	PRP	6.7
P10F231	3.62	P10SF310	3.64	P15D24024	3.72	P15F64424	3.72	PS14100	3.45
P10F233	3.62	P10SF400	3.64	P15D24124	3.72	P15F66624	3.72	PS14200	3.45
P10F24024	3.63	P10SF410	3.64	P15D24424	3.72	P15F68824	3.76	PS15000	3.45
P10F24124	3.63	P10SF500	3.63	P15D26024	3.72	P15F69924	3.76	PS15100	3.45

PART NO.	PAGE	PART NO.	PAGE	PART NO.	PAGE	PART NO.	PAGE	PART NO.	PAGE
PS15200	3.45	RPF-14050	1.11	TSCFN16D0500	3.20				
PS15300	3.45	RPF-14063	1.11	TSCFN16D1000	3.20				
PS15310	3.46	RPF-28016	1.11	TSCFN24S000	3.20				
PS15320	3.46	RPF-28020	1.11	TSCFN24S0300	3.20				
PS15330	3.46	RPF-28025	1.11	TSCFN24S0500	3.20				
PS15340	3.46	RPF-28032	1.11	TSCFN24S1000	3.20				
PS15350	3.46	RPF-28040	1.11	TSCFN32S0300	3.75				
PS15360	3.46	RPF-28050	1.11	TSCFN32S0500	3.75				
PS15370	3.46	RPF-28063	1.11	TSCFN32S1000	3.75				
PSC26024	3.43	RQ...	1.17	TSCFN36S000	3.75				
PSC26124	3.43	RS...	1.16	TZ-F478	3.85				
PSC26624	3.43	RSF-09032	1.11	TZ-F4M12	3.85				
PSC36624	3.43	RSF-09040	1.11	TZ-F578	3.85				
PSC46624	3.43	RSF-09050	1.11	TZ-F5M12	3.85				
PSC56624	3.43	RSF-09063	1.11	TZ-F5M12-B	3.85				
PSC66624	3.43	RSF-09080	1.12	TZ-M4M12-D	3.85				
PSC76624	3.43	RSF-09100	1.12	TZ-M578	3.85				
PSC86624	3.43	RT...	2.6	TZ-M578T	3.85				
PSK100145	3.46	RTF-12025	2.6	TZ-M5M12	3.85				
PSK200145	3.46	RTF-13025	2.6	TZ-M5M12-B	3.85				
PSK200290	3.46	RV...	1.23	TZ-M5M12-BT	3.85				
PSK200725	3.46	RW...	1.23	UBF	6.8				
PSK300145	3.46	S1...	1.25	UBH	6.4				
PSK401	3.46	S5...	1.26	UBK	6.8				
PSP26024	3.44	SF-12016	1.25	UBM	6.4				
PSP26124	3.44	SF-12025	1.25	UBP	6.4				
PSP26624	3.44	SF-12032	1.25	UBQ	6.4				
PSP36624	3.44	SF-12040	1.25	UBS	6.4				
PSP46624	3.44	SF-12050	1.25	UBT	6.4				
PSP56624	3.44	SF-13016	1.25	UDP	6.4				
PSP66624	3.44	SF-13025	1.25	UFL	6.4				
PSP76624	3.44	SF-13032	1.25	UGM	6.7				
PSP86624	3.44	SF-13040	1.25	UGP	6.7				
PSR220	3.44	SF-13050	1.25	UHL	6.4				
PSR221	3.44	SF-24016	1.25	UNM	6.5				
PSR222	3.44	SF-24025	1.25	UNP	6.5				
PSR223	3.44	SF-24032	1.25	VL1...	1.27				
PSR322	3.44	SF-26016	1.25	W...	1.20				
PSR422	3.44	SF-26025	1.25	WF-50012	1.20				
PSR522	3.44	SF-26032	1.25	WF-50020	1.20				
PSR622	3.44	SF-27016	1.25	WF-50032	1.20				
PSR722	3.44	SF-27025	1.25	WF-50040	1.20				
PSR822	3.44	SF-27032	1.25	WF-50050	1.20				
R...	1.21	SF-28016	1.25	WF-50063	1.20				
RM...	1.12	SF-28025	1.25	WF-50080	1.20				
RN...	1.14	SF-28032	1.25	YDA...	1.34				
RO...	1.13	TC8I412	3.85	YDG...	1.34				
RP...	1.11	TC8I808	3.85	YDR...	1.34				
RPF-10040A	1.11	TC8U412	3.85	YF...	3.95				
RPF-10050A	1.11	TCR1616	3.85	YFDA-0211	3.95				
RPF-10063A	1.11	TCR32ID	3.85	YFDA-0223	3.95				
RPF-11016	1.11	TCR32UD	3.85	YFDA-0224	3.95				
RPF-11020	1.11	TCXC	3.84	YFDB-0211	3.95				
RPF-11025	1.11	TCXD	3.84	YFDB-0223	3.95				
RPF-12016	1.11-1.13	TCXP	3.84	YFDB-0224	3.95				
RPF-12020	1.11-1.13	TCXPN	3.84	YG-6300	3.96				
RPF-12025	1.11-1.13	TIM06B	3.46	YMA...	2.10				
RPF-12040	1.11-1.13	TIM06M	3.46	YMP...	2.10				
RPF-12050	1.11-1.13	TIM1024	3.63	YR2...	1.22				
RPF-12063	1.11-1.13	TIM10B	3.46	YR240...	3.90				
RPF-13016	1.11-1.13	TIM10M	3.46	YR250...	3.90				
RPF-13020	1.11-1.13	TIM151806	3.73	YR260...	3.90				
RPF-13025	1.11-1.13	TIM1524	3.73	YR270...	3.91				
RPF-13040	1.11-1.13	TIM1536	3.73	YR280...	3.91				
RPF-13050	1.11-1.13	TIM20M	3.46	YR3...	1.23				
RPF-13063	1.11-1.13	TSCF000	3.46						
RPF-14040	1.11	TSCFN16D0300	3.20						





A series of horizontal dotted lines spanning the width of the page, providing a guide for handwriting practice.

Lined writing area with horizontal ruling lines.





A series of horizontal dotted lines spanning the width of the page, providing a guide for handwriting practice.

Lined writing area with horizontal ruling lines.





UNIVER S.p.A.

Headquarters

I - 20128 **Milano**
Via Eraclito, 31
Tel. +39 02 25298.1
Fax +39 02 2575254
info@univer-group.com
www.univer-group.com

UNIVER SERVICE S.r.l.

Headquarters

I - 20128 **Milano**
Via Empedocle, 20
Tel. +39 02 25298.1
Fax +39 02 25298370
universervice@universervice.it
www.universervice.it

Branch Offices

LOMBARDIA

I - 20128 **Milano**
Via Empedocle, 20
Tel. +39 02 25298.1
Fax +39 02 25298370
universervice@universervice.it

I - 24060 Castelli Calepio **Bergamo**

Via C. Curotti, 31/33
Tel. +39 030 7435420
Fax +39 030 733328
castellicalepio@universervice.it

I - 22040 Monguzzo **Como**

Via Valassina, 18
Tel. +39 031 617922
Fax +39 031 651222
monguzzo@universervice.it

PIEMONTE/LIGURIA/VALLE D'AOSTA

I - 10071 Borgaro Torinese **Torino**
Via Veneto, 18
Tel. +39 011 4501871
Fax +39 011 4502898
torino@universervice.it

VENETO/FRIULI VENEZIA-GIULIA TRENTINO-ALTO ADIGE

I - 30030 Vigonovo **Venezia**
Via Prima strada 16/A - Loc. Galta
Tel. +39 049 9834140
Fax +39 049 9833972
vigonovo@universervice.it

EMILIA ROMAGNA

I - 40069 Zola Predosa **Bologna**
Via Guido Rossa, 21
Tel. +39 051 753907
Fax +39 051 6184751
bologna@universervice.it

CENTER/SOUTH

I - 40069 Zola Predosa **Bologna**
Via Guido Rossa, 21
Tel. +39 051 753907
Fax +39 051 6184751
bologna@universervice.it

UNIVER DO BRASIL S/A

BRAZIL - 13474-764
Americana **São Paulo - SP**
Rua do Polyester, 29
Distrito Industrial Abdo Najjar
Tel. +55 19 3113-9400
Fax +55 19 3113-9405
atendimento@univer.com.br

UNIVER CHINA

CHINA - Shanghai
399 Fu Te North Road,
Free Zone, Pudong
info@univer-china.com

UNIVER FRANCE S.a.s.

FRANCE - 68000
Colmar
1, rue Denis Papin
Tel. +33 03 89210900
Fax +33 03 89216850
info@univer-france.fr

UNIVER G.m.b.H.

GERMANY - D-65428
Rüsselsheim
Eisenstraße 51
Tel. +49 6142 40832-0
Fax +49 6142 40832-90
info@univer-gmbh.de

UNIVER NORTH AMERICA

USA - 48312
Sterling Heights - **Michigan**
6620 Cobb Drive
Tel. +1 248 299 0525
Fax +1 248 299 0528
info@univer-group.us

UNIVER POLSKA Sp. z o.o.

POLAND - 25-663
Kielce
ul. K. Olszewskiego 21E
Tel. +48 41 278 72 53
Fax +48 41 278 72 54
univer@univer-group.pl

UNIVER S.L.

SPAIN - 08210
Barbera Del Valles **Barcelona**
Ronda Industria, 26 - 28
Tel. +34 93 7297360
Fax +34 93 7297380
univer@univerweb.com

Distributors worldwide:

Get in touch with UNIVER Sales Department
or visit our website www.univer-group.com



UNIVER S.p.A.
Headquarters

I - 20128 **Milano**
Via Eraclito, 31
Tel. +39 02 25298.1
Fax +39 02 2575254
info@univer-group.com
www.univer-group.com



www.univer-group.com